



GRDC

≡ GROWNOTES® ≡

Know more. Grow more.

Soybeans

Northern Region

March 2016

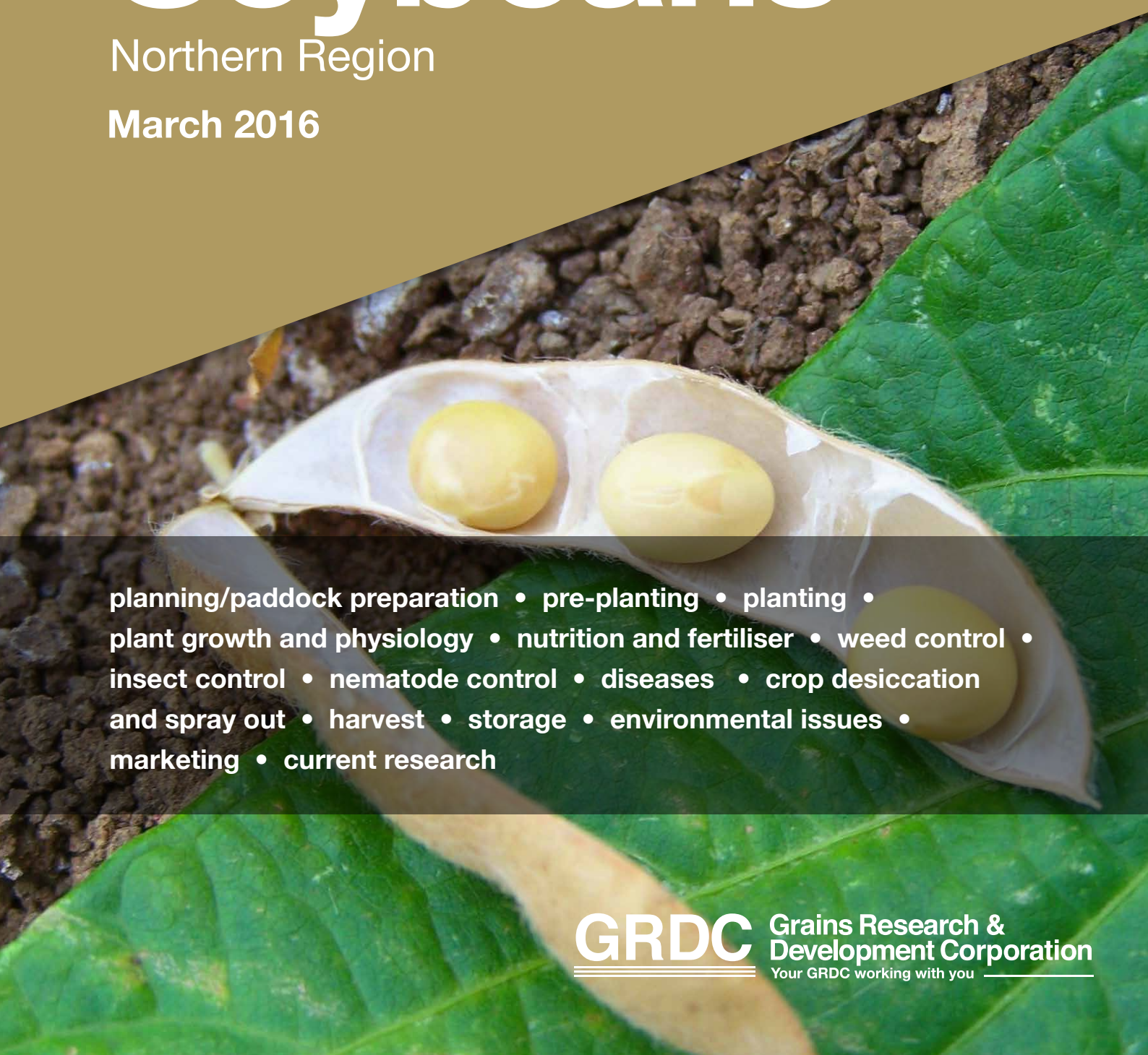

planning/paddock preparation • pre-planting • planting •
plant growth and physiology • nutrition and fertiliser • weed control •
insect control • nematode control • diseases • crop desiccation
and spray out • harvest • storage • environmental issues •
marketing • current research

GRDC

Grains Research &
Development Corporation
Your GRDC working with you

Start here for answers to your immediate soybean crop management issues

How important is seed germination and purity?



Should I inoculate seed using the soybean-specific strain of Group H inoculant (strain CB 1809)?



Seed size varies widely between varieties and seasons. Do I need use a formula to calculate sowing rates based on seed size and target plant population or bags of seed/ha?



How important is a uniform plant stand?



How can I reduce the risk of phytophthora root and stem rot?

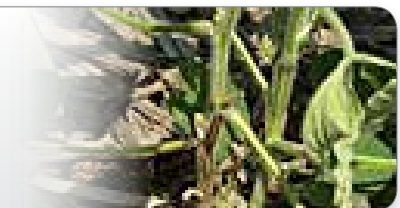

Keys to successful soybean production



Check seed germination and purity and

ENSURE SEED COAT HAS NOT BEEN DAMAGED

prior to planting

PLANT AT OPTIMUM TIME

to maximise yield potential and grain quality



ESTABLISH AND MAINTAIN A UNIFORM PLANT STAND

at the recommended plant population for your climatic and soil conditions

Wherever possible, plant soybean into a **FULL PROFILE OF SOIL MOISTURE**

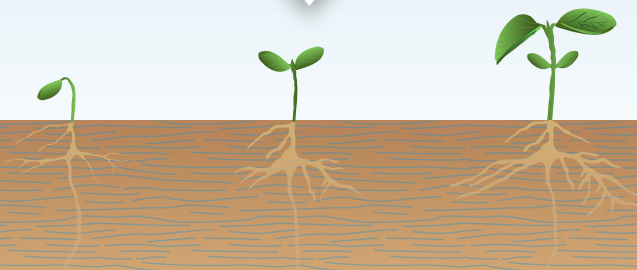

AVOID MOISTURE STRESS

from flowering to physiological maturity



Inspect crops for insect pests and beneficials at least **once a week** in the vegetative stage and then **twice a week** from flowering to maturity

✓					
✓		✓			

VEGETATIVE
FLOWERING TO MATURITY

HARVEST ASAP

Harvest soybeans as soon as possible to **maximise grain quality** by reducing the risk of weather damage or harvest losses from over-dry grain

© 2016 Grains Research and Development Corporation.

All rights reserved.

Disclaimer:

This GrowNote has been prepared in good faith on the basis of information available at the date of publication without any independent verification. The Grains Research and Development Corporation does not guarantee or warrant the accuracy, reliability, completeness of currency of the information in this publication nor its usefulness in achieving any purpose.

Readers are responsible for assessing the relevance and accuracy of the content of this publication. The Grains Research and Development Corporation will not be liable for any loss, damage, cost or expense incurred or arising by reason of any person using or relying on the information in this publication.

Products may be identified by proprietary or trade names to help readers identify particular types of products but this is not, and is not intended to be, an endorsement or recommendation of any product or manufacturer referred to. Other products may perform as well or better than those specifically referred to.

Contents

A Introduction

A.1 Crop overview	xii
A.1.1 Grain soybean	xiv
A.1.2 Fallow/green manure soybean	xv
A.1.3 Forage soybean	xvi
A.2 Executive summary	xvi

1 Planning/Paddock preparation

1.1 Paddock selection	1
1.1.1 Land management	1
1.1.2 Conventional tillage	1
1.1.3 Controlled traffic and permanent beds	1
1.1.4 Zonal tillage	2
1.1.5 Zero tillage	3
1.1.6 Managing grass (cane, wheat) residue to facilitate soybean planting	4
1.1.7 Managing soybean residue to facilitate grass (cane, wheat) planting and to maximize the benefits of soybean	4
1.2 Benefits of crop as a rotation crop	5
1.2.1 Soybean and their use in crop rotation	5
1.3 Fallow weed control	5
1.4 Seedbed requirements	6
1.4.1 Soil pH, acidity and liming	6
1.4.2 Soil Salinity	7
1.5 Soil moisture	7
1.5.1 Dryland	7
1.5.2 Irrigation	7
1.5.3 Double crop options	9
1.6 Nematode status of paddock	9
1.6.1 Effects of cropping history on nematode status	9

2 Pre-planting

2.1 Varietal performance and ratings yield	1
2.1.1 Variety selection	1
2.1.2 Photoperiod	1
2.1.3 Regional adaption	2
2.1.4 Southern NSW and Victoria	2
<i>Curringa</i>	2
<i>Djakal</i>	3
<i>Snowy</i>	3
2.1.5 Central NSW	3
<i>Cowrie</i>	3
<i>Ivory</i>	3
2.1.6 NSW Northern Tablelands	4
<i>Intrepid</i>	4
2.1.7 Northern NSW (dryland and irrigation)	4
<i>Hale</i>	4
2.1.8 NSW North Coast	4
<i>A6785</i>	5
<i>Hayman</i>	5
<i>Manta</i>	5
<i>Moonbi</i>	5
<i>Poseidon</i>	6
<i>Richmond</i>	6
<i>Soya 791</i>	7
<i>Surf</i>	7

<i>Zeus</i>	7	A
2.1.9 Southern Queensland	7	
<i>Bunya</i>	7	1
<i>Fraser</i>	8	
<i>Hayman</i>	8	
<i>Jabiru</i>	8	2
<i>Oakey</i>	8	
<i>Richmond</i>	8	
<i>Warrigal</i>	8	
2.1.10 Tropical Queensland	9	3
<i>Leichhardt</i>	9	
<i>Stuart</i>	9	
2.1.11 Yielding ability	9	
2.2 Planting seed quality	9	4
2.2.1 Seed size	9	
2.2.2 Seed storage	9	
2.2.3 Safe rates of fertiliser sown with the seed	10	5
3 Planting		
3.1 Inoculation	1	6
3.1.1 Slurry inoculation	2	
3.1.2 Water injection and in-furrow sprays	2	
3.1.3 Pelleted seed	3	
3.1.4 Nodulator® granules	3	
3.1.5 Rhizobia, molybdenum and checking nodules	3	7
3.2 Time of sowing	4	
3.2.1 New South Wales and northern Victoria	4	
3.2.2 Queensland southern and inland	4	
3.2.3 Queensland central and north coastal	5	8
3.3 Targeted plant population	5	
3.4 Calculating seed requirements	6	
3.4.1 Establishment percentage	7	9
3.4.2 Row spacing and configuration	7	
<i>Dryland</i>	8	
<i>Irrigated</i>	8	
<i>Tropical Queensland cane systems</i>	9	10
3.5 Sowing depth	10	
4 Plant growth and physiology		
4.1 Germination and emergence issues	1	11
4.2 Plant growth stages	1	
4.2.1 Emergence (VE)	1	
4.2.2 Cotyledon stage (VC)	2	12
4.2.3 First trifoliolate (V1)	2	
4.2.4 Second node (V2)	2	
4.2.5 Third to fifth nodes (V3-V5)	2	
4.2.6 Sixth node (V6)	3	13
4.2.7 Beginning bloom (R1)	3	
4.2.8 Full bloom (R2)	3	
4.2.9 Beginning pod (R3)	3	
4.2.10 Full pod (R4)	4	14
4.2.11 Beginning seed (R5)	4	
4.2.12 Full seed (R6)	4	
4.2.13 Beginning maturity (R7)	4	15
4.2.14 Full maturity (R8)	5	
5 Nutrition and fertiliser		
5.1 Crop removal rates	1	16

5.2	Soil testing	1
5.3	Nitrogen (N).....	1
5.4	Phosphorus (P)	2
5.5	Sulphur (S)	3
5.6	Potassium (K).....	3
5.7	Micronutrients	4
5.7.1	Zinc (Zn)	4
5.7.2	Molybdenum (Mo)	5
5.7.3	Other trace elements.....	5
5.8	Nutritional deficiencies	5
5.8.1	Boron (B) deficiency	5
5.8.2	Calcium (Ca) deficiency.....	6
5.8.3	Iron (Fe) deficiency	6
5.8.4	Magnesium (Mg) deficiency	6
5.8.5	Manganese (Mn) deficiency/toxicity.....	7
5.8.6	Nitrogen (N) and Molybdenum (Mo) deficiency.....	7
5.8.7	Phosphorus (P) deficiency	8
5.8.8	Potassium (K) deficiency.....	9
5.8.9	Sulphur (S) deficiency	10
5.8.10	Zinc (Zn) deficiency	10
6	Weed control	
6.1	Pre-emergent herbicides	2
6.1.1	Grasses	2
6.1.2	Broadleaf.....	3
6.2	Post-plant pre-emergent herbicides.....	5
6.3	In-crop herbicides: knock downs and residuals.....	5
6.4	Integrated Weed Management (IWM)	6
6.5	Weed control in organic soybeans.....	6
6.6	Harvest-aid herbicides – desiccating the crop	7
7	Insect control	
7.1	Name and description of pest (identification)	2
7.1.1	Helicoverpa (<i>Helicoverpa armigera</i> , <i>H. punctigera</i>).....	2
7.1.2	Pod-sucking bugs	4
	Green vegetable bug (GVB), <i>Nezara viridula</i>	4
	Redbanded shield bug (RBSB), <i>Piezodorus oceanicus</i>	6
	Large brown bean bug, <i>Riptortus serripes</i>	
	Hemiptera: Alydidae.....	7
	Small brown bean bug, <i>Melanacanthus scutellaris</i>	
	Hemiptera: Alydidae.....	8
	Brown shield bug, <i>Dictyotus caenosus</i> (Westwood)	
	Hemiptera: Pentatomidae	8
7.1.3	Silverleaf whitefly (SLW), <i>Bemisia tabaci</i> biotype B.	9
7.1.4	Soybean stemfly (<i>Melanagromyza sojae</i>)	12
7.2	Moderate, less frequent and minor pests	13
7.2.1	Cluster caterpillar <i>Spodoptera litura</i> (often referred to as ‘spods’) ...	13
7.2.2	Bean podborer <i>Maruca vitrata</i> (previously <i>Maruca testulalis</i>)	15
7.2.3	Etiella (lucerne seed web moth), <i>Etiella behrii</i>	16
7.2.4	Large mystery planthopper <i>Oteana lubra</i> (Cixiidae).....	18
7.2.5	Loopers	19
	Green loopers.....	19
	Brown loopers.....	20
7.2.6	Common grass blue (butterfly) <i>Zizina labradus</i>	
	Lepidoptera: Lycaenidae.....	21
7.2.7	Leaf miners and webbers.....	23
	Soybean moth <i>Aproaerema simplexella</i> (previously <i>Stomopteryx simplexella</i>).....	23

	<i>Legume webspinner or bean leafroller Omiodes diemenalis</i> (previously <i>Lamprosema abstimalis</i>)	24	A
7.2.8	Beetle pests	26	1
	<i>Monolepta</i> or redshouldered leaf beetle or <i>Monolepta australis</i>	26	
	Lucerne crown borer or zygrita <i>Zygrita diva</i>	27	
	Soybean aphid <i>Aphis glycines</i>	28	2
7.2.9	Mirids		
	Hemiptera: Miridae.....	29	
7.2.10	Two-spotted or red spider mite <i>Tetranychus sp.</i>	30	
7.2.11	Field Crickets	31	3
7.2.12	Black field earwig <i>Nala lividipes</i>	32	
7.2.13	Slugs	32	
7.2.14	Mouse plagues.....	34	
7.3	Thresholds for control.....	34	4
7.3.1	Yield-based thresholds	35	
7.3.2	Nominal thresholds	36	
7.3.3	Benefit:Cost Ratio	36	5
7.3.4	Defoliation thresholds	37	
7.3.5	Quality-based or preventative thresholds	37	
7.3.6	Thresholds for immature pests	38	
7.3.7	Estimating/calculating crop size as required for podsucking bug thresholds.....	40	6
	<i>Researcher's method</i>	40	
	<i>Experienced agronomist's method</i>	40	
7.3.8	Soybean thresholds at a glance.....	41	7
7.4	Management of insect pest	42	
7.4.1	Sampling, scouting, monitoring and record keeping	42	
	<i>What is a beat sheet?</i>	42	
	<i>How to use the beat sheet</i>	43	8
	<i>Other tips when using the beat sheet</i>	43	
	<i>Correcting podsucking bug beat sheet counts for sampling inefficiencies</i>	44	
	<i>Converting sample totals for different row spacing</i>	44	
	<i>Keeping records</i>	44	9
7.4.2	Integrated Pest Management (IPM)	45	
	<i>IPM and pesticides</i>	45	
	<i>Soft and hard pesticides</i>	46	10
	<i>IPM and organics</i>	46	
	<i>IPM and biological control</i>	46	
	<i>The soybean IPM strategy</i>	46	
	<i>What is needed for IPM to work?</i>	47	11
7.4.3	Insecticides	47	
	<i>Factors to consider when choosing an insecticide</i>	47	
	<i>Insecticide groups</i>	47	
	<i>Route of entry – how they enter the target pest</i>	48	12
	<i>Mode of action (i.e. how they kill pests and the body systems attacked)</i>	48	
	<i>Chemical structure (classification)</i>	48	
	<i>Making the choice – factors to consider</i>	49	13
	<i>Efficacy</i>	49	
	<i>Susceptibility of the crop to pest damage</i>	49	
	<i>Impact on natural enemies</i>	49	
	<i>Resistance management strategies for your region or a particular product</i>	50	14
7.4.4	Presence of other pests also requiring control	50	
	<i>Withholding periods and insecticide residues</i>	50	
	<i>Toxicity to the environment and humans</i>	50	15
	<i>Exclusion zones</i>	51	
	<i>Cost</i>	51	
	<i>New generation insecticides, indoxacarb (Steward) and spinosad (Tracer II)</i>	51	16
	<i>Biopesticides – NPV (ViVUSMax) and Bt (DipelSC)</i>	51	
	<i>Carbamates (e.g. Larvin, Lannate)</i>	52	17

Organophosphates or OPs (e.g. Dimethoate)	52
Organochlorines (Cyclodeines) (e.g. Endosulfan).....	53
Synthetic Pyrethroids or SPs (e.g. Alpha-Scud, Ballistic, Cypermethrin, Dominex)	53
7.4.5 Post-spray assessments.....	53
7.4.6 Legal issues.....	54
Registration.....	54
Labels.....	54
MSDS.....	55
Permits.....	55
APVMA.....	55
7.4.7 Soybean insecticides	56
7.4.8 Making control decisions	57
7.5 Beneficial insects	59
7.5.1 Use of the predator to pest ratio in spray decisions	60
7.6 Key parasitoids and predators.....	61
7.6.1 Large predatory bugs.....	61
7.6.2 Small predatory bugs.....	62
7.6.3 Predatory beetles	63
7.6.4 Wasp parasitoids – of helioverpa and other caterpillars	66
7.6.5 Fly parasitoids.....	67
7.6.6 Hoverflies - key aphid predators.....	68
7.6.7 Lacewings – key aphid predators	68

8 Nematode management

8.1 Background	1
----------------------	---

9 Diseases

9.1 Name and description of disease (when and how to identify).....	1
9.1.1 Fungal diseases	1
9.1.2 Seedling root rots (<i>Rhizoctonia solani</i> , <i>Phytophthora</i> <i>sojiae</i> , and <i>Pythium species</i>).....	1
9.1.3 Charcoal rot (<i>Macrophomina phaseolina</i>).....	2
9.1.4 Phytophthora stem and root rot (<i>Phytophthora sojiae</i>).....	3
9.1.5 Sclerotinia stem rot (<i>Sclerotinia sclerotiorum</i>).....	4
9.1.6 Sclerotium base rot (<i>Sclerotium rolfsii</i>).....	5
9.1.7 Phomopsis pod and stem blight and seed decay (several <i>Phomopsis/Diaporthe</i> species).....	5
9.1.8 Rhizoctinia root rot (<i>Rhizoctonia solani</i>)	6
9.1.9 Rust (<i>Phakopsora pachyrhizi</i>)	6
9.1.10 Downy mildew (<i>Peronospora manshurica</i>).....	7
9.1.11 Purple seed stain (<i>Cercospora kikuchii</i>)	8
9.1.12 Powdery mildew (<i>Erysiphe diffusa</i>).....	9
9.1.13 Bacterial diseases	9
9.1.14 Bacterial blight (<i>Pseudomonas syringae</i> pv. <i>glycinea</i>)	9
9.1.15 Bacterial pustule (<i>Xanthomonas axonopodis</i> pv. <i>glycines</i>)	10
9.1.16 Wildfire (<i>Pseudomonas syringae</i> pv. <i>tabaci</i>).....	11
9.1.17 Big bud (also called witch's broom and little leaf).....	11
9.1.18 Viruses.....	11
9.1.19 Nematodes	12
9.1.20 Sunburn.....	12
9.2 Varietal resistance or tolerance.....	12
9.3 Conditions favouring development.....	12
9.4 Management of disease	13
9.4.1 Integrated Disease Management	13
Best practice strategies	13
9.4.2 Risk Assessment.....	14
Identify the factors that determine risk.....	14
Analyse specific known risk factors	14

<i>Acknowledge your own acceptable risk level</i>	15
<i>Providing Accurate Diagnosis</i>	15
9.4.3 Tools of the trade	16
10 Plant growth regulators and canopy management	
11 Crop desiccation/spray out	
12 Harvest	
12.1 Harvesting.....	1
12.2 Pre harvest check lists.....	2
12.2.1 Row spacing - narrow or wide?	2
12.2.2 Pre-harvest header/combine check	2
12.3 Harvest timing.....	2
12.4 Desiccants	3
12.5 Harvest losses	3
12.5.1 How to measure harvest performance.....	3
12.5.2 Pre-harvest losses.....	4
12.5.3 Gathering losses	5
12.5.4 Processor losses.....	8
12.6 Bin sample quality	10
12.7 Handy hints.....	10
12.7.1 How to measure losses.....	12
12.7.2 Buying a Harvester.....	12
12.8 Wet harvest issues and management.....	13
12.9 Receival standards	13
12.10 Harvest weed seed management.....	13
13 Storage	
13.1 How to store product on-farm.....	1
13.1.1 Types of storage.....	1
13.1.2 Deterioration indicators.....	2
<i>Heating</i>	2
<i>Change in colour and general appearance</i>	2
<i>Mustiness and off-odour condition</i>	2
<i>Presence of storage insects</i>	3
<i>Lumping and caking</i>	4
<i>Chemical changes in storage</i>	4
13.2 Stored grain pests	4
13.3 Grain protectants for storage.....	8
13.3.1 Fire Risk.....	9
13.4 Aeration during storage	9
13.4.1 Aeration cooling	10
13.4.2 Automatic controllers	10
13.4.3 Standard aeration fans operation.....	11
13.4.4 Aeration drying	11
13.4.5 Heated air drying.....	12
13.4.6 Moisture content	12
13.4.7 Temperature	12
13.4.8 Duration of storage	13
13.4.9 Foreign material present	13
13.4.10 Product condition and history.....	13
14 Environmental issues	
14.1 Waterlogging/flooding issues for soybean	1
14.2 Other environmental issues	1
14.2.1 Heat canker.....	1

14.2.2 Salinity..... 1

14.2.3 Soil acidity..... 1

14.2.4 Sooty mould.....2

14.2.5 Sunburn.....2

15 Marketing

15.1 Selling principles..... 1

15.1.1 Be prepared..... 1

When to sell 1

How to sell 2

15.1.2 Establishing the business risk profile—when to sell2

Production risk profile of the farm..... 2

Farm costs in their entirety, variable and fixed costs (establishing a target price) 3

Income requirements 4

Summary..... 5

15.1.3 Managing your price—how to sell5

Methods of price management..... 5

Summary..... 7

15.1.4 Ensuring access to markets.....7

Storage and logistics..... 8

Cost of carrying grain..... 9

Summary..... 9

15.1.5 Executing tonnes into cash 10

Set up the toolbox..... 10

How to sell for cash 10

Counterparty risk..... 13

Relative values 13

Contract allocation..... 14

Read market signals..... 14

Summary..... 15

15.2 Northern soybeans—market dynamics and execution 15

 15.2.1 Price determinants for northern soybeans..... 15

 15.2.2 Executing tonnes into cash for Northern soybeans..... 16

16 Current research

17 Key contacts

18 References

A
1
2
3
4
5
6
7
8
9
10
11
12
13
14
15
16
17
18

SECTION A

Introduction

 More information

[GRDC 2010 Raising the bar with better Soybean Agronomy](#)

A.1 Crop overview

Soybean or soya bean is a species of legume (*Glycine max*) native to eastern Asia. It is classified as an oilseed rather than a pulse due to its high oil content and its more popular use as a source of vegetable oil and industrial applications such as biodiesel. It has been grown in China for over 5,000 years.

It has a raft of applications including a source of vegetable oil for human food and industrial uses, as a valued protein source in livestock production, for use in preparing a range of human foods such as traditional foods like tofu and soy milk as well as novel uses as a protein isolate and for textured protein. Soybean also has an almost endless application in industrial products such lubricants, plastics, waxes and a range of intermediate chemicals including fatty acids. And in more recent times, soybean has been recognised for its health and well being properties and is now used in a range of nutrition bars, cereals, pasta and baked goods.



Figure 1: Soybean kibble is used in food including multigrain bread. (Photo: Rebecca Thyer)

Soybeans typically contain about 40% protein, 20% oil and 35% carbohydrates. Soy oil is the major food product used worldwide and after extraction the protein is used as a valued meal for livestock. However the protein is also used in soy foods requiring high temperature processing such as tofu, soy milk and textured vegetable proteins.¹

¹ Soy Australia, soybean fact sheets: http://www.australianoilseeds.com/soy_australia/soybean_fact_sheets

Soybean is not only the most important grain legume crop grown in the world because of its dual purpose oil and protein production, it also has important properties that make it a very flexible crop in cropping systems.²

The largest soybean production area in Australia is the New South Wales north coast. Other important regions include inland northern NSW, the southern Queensland coast, the Riverina, and the north-west of Western Australia and Northern Territory. With a wide latitude range (12° to 36° south) and different daylight-length and district differences in temperatures, disease and environments, developing Australian varieties has been a sizeable challenge.

Australian soybean areas are different to other soybean-growing regions such as in the US. Desirable traits for Australian growing conditions, such as disease resistance, high quality and agronomic aspects, are not readily available in overseas varieties.³

The soybean industry is represented by Soy Australia which was formed with the support of the following organisations:

- Australian Oilseeds Federation (AOF)
- Northern Australian Soybean Industry Association (NASIA)
- North Coast Oilseed Growers Association (NCOGA)
- Riverina Soybean Growers Association (RSGA)⁴

Table 1: Australian soybean oilseed production

Market Year	Production	Unit of Measure	Growth Rate
1964	1	(1000 MT)	NA
1965	1	(1000 MT)	0.00 %
1966	1	(1000 MT)	0.00 %
1967	2	(1000 MT)	100.00 %
1968	2	(1000 MT)	0.00 %
1969	5	(1000 MT)	150.00 %
1970	9	(1000 MT)	80.00 %
1971	28	(1000 MT)	211.11 %
1972	38	(1000 MT)	35.71 %
1973	63	(1000 MT)	65.79 %
1974	74	(1000 MT)	17.46 %
1975	45	(1000 MT)	-39.19 %
1976	55	(1000 MT)	22.22 %
1977	77	(1000 MT)	40.00 %
1978	99	(1000 MT)	28.57 %
1979	82	(1000 MT)	-17.17 %
1980	73	(1000 MT)	-10.98 %
1981	77	(1000 MT)	5.48 %
1982	53	(1000 MT)	-31.17 %
1983	89	(1000 MT)	67.92 %
1984	110	(1000 MT)	23.60 %
1985	105	(1000 MT)	-4.55 %
1986	115	(1000 MT)	9.52 %
1987	68	(1000 MT)	-40.87 %

² Australian Oilseeds Federation (2013), Better Soybeans manual http://www.australianoilseeds.com/soy_australia/Soybean_Production

³ GRDC (2014) Australian Soybeans come of age <http://www.grdc.com.au/Media-Centre/Ground-Cover/Ground-Cover-Issue-113-NovDec-2014/Australian-soybeans-come-of-age#sthash.2qG1Lio.dpuf>

⁴ Soy Australia: http://www.australianoilseeds.com/soy_australia

Market Year	Production	Unit of Measure	Growth Rate
1988	129	(1000 MT)	89.71 %
1989	77	(1000 MT)	-40.31 %
1990	62	(1000 MT)	-19.48 %
1991	63	(1000 MT)	1.61 %
1992	51	(1000 MT)	-19.05 %
1993	81	(1000 MT)	58.82 %
1994	28	(1000 MT)	-65.43 %
1995	44	(1000 MT)	57.14 %
1996	74	(1000 MT)	68.18 %
1997	54	(1000 MT)	-27.03 %
1998	109	(1000 MT)	101.85 %
1999	105	(1000 MT)	-3.67 %
2000	49	(1000 MT)	-53.33 %
2001	63	(1000 MT)	28.57 %
2002	18	(1000 MT)	-71.43 %
2003	74	(1000 MT)	311.11 %
2004	54	(1000 MT)	-27.03 %
2005	56	(1000 MT)	3.70 %
2006	32	(1000 MT)	-42.86 %
2007	35	(1000 MT)	9.38 %
2008	80	(1000 MT)	128.57 %
2009	60	(1000 MT)	-25.00 %
2010	30	(1000 MT)	-50.00 %
2011	86	(1000 MT)	186.67 %
2012	92	(1000 MT)	6.98 %
2013	32	(1000 MT)	-65.22 %
2014	46	(1000 MT)	43.75 %
2015	60	(1000 MT)	30.43 %

(Source: Index Mundi)⁵

A.1.1 Grain soybean

The vast majority of soybean grown in Australia is harvested for grain. Grain soybean will deliver all the agronomic benefits of a legume in the crop rotation sequence with, for example, maize, wheat or sugarcane. However, an important additional benefit is the cash income that can be generated by taking the crop through to grain harvest.

There are three main markets for grain soybean in Australia. The underlying backbone of the industry is the oilseed crushing sector. Crushing soybean is processed into vegetable oils for further processing into table oils and margarine spreads and also for animal feed. This market is heavily influenced by the import parity price of soybean meal from North and South America. Soybean varieties with a dark coloured hilum can only be sold for oil and crushing as hilum colour is not critical for this market.

The oil from grain soybean can also be used for industrial applications such as biodiesel.

⁵ Index Mundi, Australia Soybean Oilseed Production by Year: <http://www.indexmundi.com/agriculture/?country=au&commodity=soybean-oilseed&graph=production>



Figure 2: Twin crop trials of soybean and sunflower. (Photo: GRDC)

Grain soybean can also target the human food sector. Edible grade soybean of superior quality can be sold into the high end culinary market to be processed into a variety of foodstuffs such as milk, tofu and a variety of baking additives such as kibble and flour. This market prefers high protein beans of a large size and only clear or pale coloured hilum varieties are accepted. Soybean that does not satisfy the superior quality required for milk and tofu but still meet all the other quality specifications for colour, protein and size can be sold into the edible flour market.⁶

A.1.2 Fallow/green manure soybean

Soybean has gained popularity as a fallow/green manure option in the sugar industry on Queensland's wet tropical coast. In this region it is not practical to consider soybean as a grain crop as consistent seasonal rains will cause harvesting difficulties in the majority of years. However, as soybean grows very well under high rainfall conditions it is considered highly desirable as a break or fallow crop in the sugarcane cropping system where it is largely managed as a green manure crop. In effect soybean is replacing more traditional green manure crops such as cowpea and lablab because it produces more dry matter (Table 2) with a higher nitrogen concentration (3.0-3.5% N compared with 2.0-2.5% for cowpeas).

Table 2: Example of fallow legume alternatives

Legume species	Dry matter (kg/ha)	N returned (kg/ha)
Broadcast cowpeas	3,313	50
Planted cowpeas	4,689	140
Planted soybean	7,429	310

Soybean N returned is for incorporation of the whole crop. If harvested for grain 66% is removed with the grain.

As a green manure, soybean can be sown anytime from late October to December. This usually fits in well with the sugarcane cropping system where the last ratoon is often cut at the end of the season and ploughed out. Cane is then re-planted in the following autumn/winter following a 6-9 month legume break period.

The varieties Leichhardt and Stuart are well adapted to the tropics, with Leichhardt, in particular, being ideally suited as a green manure crop. The inclusion of soybean in the

⁶ Australian Oilseeds Federation (2013), Better Soybeans manual http://www.australianoilseeds.com/soy-australia/Soybean_Production

sugarcane cropping system in the wet tropics provides a range of benefits, even though the grain is not harvested. These include:

- Good biomass production being well adapted to wet conditions.
- Better tolerance of waterlogging than other legumes such as lablab and Meringa cowpeas.
- Capacity to produce more dry matter and fix more nitrogen per hectare than alternatives.
- More potential soil health benefits by reducing soil borne diseases and lesion nematode numbers.
- A weed control option that will benefit the following plant cane crop.
- Good groundcover for erosion control over the heavy summer rainfall period.

In tropical areas, south of the wet tropics (Burdekin and Mackay) both Leichhardt and Stuart are suitable for grain production.

Traditionally green manure legumes in the sugar industry have been broadcast and disced into the soil. Recent research has shown that their growth and beneficial contribution can be greatly enhanced by establishing them with a planter, using raised beds or ridges and applying a pre-emergent herbicide. Good weed control in the legume will carry through to the next cane crop.⁷

A.1.3 Forage soybean

Although not widely used for the purpose, soybean crops are suitable for both green-chop and hay and silage production, particularly in the sheep, beef and dairy production systems of northern NSW. The best forage yields can be expected from early-planted, long-season varieties, cut around the mid-podfill stage. The preferred varieties for southern Queensland districts appear to be Warrigal, Jabiru and Oakey while Leichardt is the most suitable for the tropics. In northern NSW the varieties Warrigal and A6785 ('Asgrow') are most commonly used for this purpose. In dry years where grain crops fall short on rainfall to finish many producers will cut soybeans for high quality hay. The high protein content of the hay is perfect to be used in supplementary feeding rations, or feed to livestock as a source of high quality fibre and protein.

Silage yields (at around 35% dry matter, cut at the milky-dough/pod fill stage) can be expected to be around 25 t/ha. This equates to around 8 t/ha dry matter yield.⁸

A.2 Executive summary

- Choose a variety that is recommended for your region and plant it at the optimum time to maximise yield potential and grain quality.
- Wherever possible, plant soybean into a full profile of soil moisture unless irrigation is available. Irrigated soybean fields should preferably be pre-irrigated and have an irrigation budget of 6-8 ML/ha. Avoid moisture stress from flowering to physiological maturity.
- Check seed germination and purity—insist on a current germination test certificate. Ensure seed coat has not been damaged prior to planting.
- Always inoculate seed correctly using the soybean-specific strain of Group H inoculant (strain CB 1809).
- Plan weed control measures carefully selecting appropriate herbicides (pre-emergent and/or post-emergent) and/or use inter-row cultivation. Always try to control weeds before you plant.

⁷ Australian Oilseeds Federation (2013), Better Soybeans manual http://www.australianoilseeds.com/soy_australia/Soybean_Production

⁸ Australian Oilseeds Federation (2013), Better Soybeans manual http://www.australianoilseeds.com/soy_australia/Soybean_Production

FAQ

- Seed size varies widely between varieties and seasons. Check the bag for seed size and use a formula to calculate sowing rates based on seed size and target plant population (not on bags of seed/ha).
- Establish and maintain a uniform plant stand at the recommended plant population for your climatic and soil conditions.
- Take a soil test prior to planting. Correct any nutritional deficiencies of phosphorus, sulphur, potassium and trace elements (in particular zinc on heavy clay soils). Potassium is commonly deficient in the sugarcane system on many soil types.
- Inspect crops for insect pests and beneficials at least once a week in the vegetative stage and then twice a week from flowering to maturity.
- Reduce the risk of phytophthora root and stem rot by using resistant varieties and selecting paddocks with good drainage and a disease-free history.
- Harvest soybeans as soon as possible to maximise grain quality by reducing the risk of weather damage or harvest losses from over-dry grain.⁹

⁹ Australian Oilseeds Federation (2013), Better Soybeans manual http://www.australianoilseeds.com/soy_australia/Soybean_Production

SECTION 1

Planning/Paddock preparation

1.1 Paddock selection

1.1.1 Land management

Probably the hardest part about growing a good soybean crop is to get good crop establishment. In most areas 200,000–300,000 plants per hectare are required to get maximum yields. Soybean is very sensitive to soil water during the establishment stage up until the four leaf stage. If the soil is too wet seed will rot and if too dry it will fail to germinate and/or die before emergence. Soybeans are intolerant of soil salinity and need soil with 2dS/m ECs and irrigation water needs to be less than 1.5 dS/m ECw. Thus land preparation is a very important consideration when planting soybean. A range of options can be employed. These are detailed below.¹

1.1.2 Conventional tillage

With conventional tillage the whole paddock is prepared prior to planting. Initial cultivations are usually done with discs, chisels or heavy scarifiers. The aim is to have 20 to 25 cm of loose soil allowing the formation of raised hills or beds. However, land preparation will vary according to the particular soil type. Where soybean is grown in rotation with sugarcane, the cane can be sprayed out prior to cultivations or disced out during the land preparation. On light sandy soils, cultivation should not be excessive while heavier soils may require more working to obtain a satisfactory seedbed.² Avoid leaving seed bed with large clods as they will harbor weed seeds that will not be controlled by pre emergents and reduce seedling population as seedlings emerge.

1.1.3 Controlled traffic and permanent beds

Controlled traffic farming is becoming more popular for many cropping enterprises as increased knowledge is gained of its benefits. Soybean is no exception. Controlled traffic farming involves having permanent traffic zones and permanent crop zones to avoid the adverse effects on crop growth of compaction caused by heavy machinery. A system that controls traffic separates wheel tracks and the cropping zone.

Where in conventional farming the whole soil surface area of the field is worked to make it suitable for cropping, with controlled traffic only the cropping area is worked and not the wheel tracks. These remain permanent across crop cycles. With controlled traffic, compaction caused by the passage of heavy machinery is isolated from the cropping zone. Soil compaction has an adverse effect on crop yield through limiting water and nutrient supply to the crop.

Controlled traffic requires equipment to be modified so all wheel widths match, allowing tyres to run on the same permanent wheel tracks with every operation. This can be done very cheaply by using guide arms to mark the rows. However, natural driver error

¹ Australian Oilseeds Federation (2013), Better Soybeans manual http://www.australianoilseeds.com/soy_australia/Soybean_Production

² Australian Oilseeds Federation (2013), Better Soybeans manual http://www.australianoilseeds.com/soy_australia/Soybean_Production

limits the success of guide arms. The most effective way is to move to satellite guided systems, or auto steer systems, that remove driver error.

Whether by design or not, controlled traffic systems will result in planting on beds. These beds can be either flat (drier areas) or raised to improve drainage in wet conditions.

Over time, as the permanent traffic lanes become more consolidated, it becomes easier to drive the machinery down the compacted tramlines, using less fuel and allowing earlier field access after rain. At the same time, in the planting zone, the soil profile develops an improved structure and better moisture holding capacity. The establishment of permanent traffic lanes facilitates a movement towards, initially, zonal tillage (tilling only the crop area) and eventually, in some situations, the move to zero tillage can occur.

Increasingly, controlled traffic and GPS guided systems are also moving toward the incorporation of permanent raised beds or hills. In the wet tropics and coastal areas it is advisable to sow soybeans on raised beds or hills to allow for better drainage during the wet summer months. Hill or bed formation can be done prior to sowing though some planters can be fitted with hill/bed forming equipment to allow planting and bed formation to be carried out in a single operation. In areas with lower rainfall, soybeans can be planted without forming beds.³

1.1.4 Zonal tillage

As the name implies, tillage is carried out in zones. This concept is based on the premise that cultivation should only be carried out when absolutely necessary and that crop-growth zones and traffic zones should be separated on a permanent basis. Thus zonal tillage is an integral part of a controlled traffic system and is important in maintaining the compacted traffic lanes and non compacted cropping lanes.

Other advantages include:

- being able to use smaller tractors;
- savings in time and fuel;
- non compaction of the cropping zone benefiting root growth and drainage;
- compaction of traffic zone allowing quicker access onto the paddock following rainfall;
- and provision of a friable seedbed to facilitate crop establishment.

Soybean can be planted in the cultivated zones (beds) with row crop planters. It is important to ultimately match wheel spacings of planters, harvesters, tractors and spray rigs to preserve the structural integrity of the beds and retain controlled traffic zones.⁴

Zonal tillage can also be used between the rows of soybean stubble once the crop has been harvested to create a planting zone for the following crop, for example, sugar cane as illustrated in Figures 1 and 2 below.

³ Australian Oilseeds Federation (2013), Better Soybeans manual http://www.australianoilseeds.com/soy-australia/Soybean_Production

⁴ Australian Oilseeds Federation (2013), Better Soybeans manual http://www.australianoilseeds.com/soy-australia/Soybean_Production



Figure 1: Zonal or strip tillage applied to the inter-row of soybean crop stubble using a 'Soil Soldier'. The objective is to encourage better rainfall penetration and create a zone that is conducive to rapid germination of cane sets planted in a dual row between the three soybean rows on the bed, whilst causing minimal disturbance to the structure of the beds and maintaining controlled traffic zones. (Photos: Alan Munro, Woodford Dale, NSW)



Figure 2: Zonal tillage using a power harrow and crumbler roller was applied to the top of these beds. In this example, different depths of zonal tillage (50 mm and 125 mm) were applied at variable times prior to planting cane in September. The overall objective is to incorporate soybean crop stubble and create a zone conducive to growth of the cane sets whilst retaining the bed structure and controlled traffic zones. (Photos: Alan Munro, Woodford Dale, NSW)

1.1.5 Zero tillage

Zero tillage is the ultimate for developing a sustainable farming system. It is the next step up from zonal tillage. After the permanent cropping and traffic lanes are firmly established the cropping lanes should remain friable enough to be able to be directly seeded into the undisturbed soil. However, friability may vary with soil type. Trash or stubble management will be an issue. This is addressed below.

There are a number of advantages to this system in addition to those captured with zonal tillage:

- more time and fuel savings
- less capital involved in cultivation machinery
- can be done on slopes not suitable for conventional tillage due to erosion hazards
- maintains a better soil structure
- planting moisture is not lost through tillage
- Increased water retention and reduced runoff

In coastal farming systems, zero-till systems have been developed in rotations with sugarcane where soybean is sown on either side of the cane row and cane is planted into the soybean residue. Volunteer cane can be controlled with grass selective herbicides while the soybean can be controlled with a broadleaf selective

herbicide. However, in most cases the soybean will be allowed to grow. It will be easily outcompeted by the cane.

A system now being practised in many cane areas is the development of 1.8 m controlled traffic beds onto which three soybean rows are planted. At the end of the soybean crop, two rows of cane are directly planted into the beds through the soybean residue.

Cane farms using this system involving soybean breaks have reported 20% yield increases in the following cane crop.

When sowing soybean into sugar cane trash several issues must be considered. Soybean does not grow well in compacted soil and a ripper tine along the cane stools will loosen the area where soybean is planted without disturbing the trash on the surface.⁵ The use of covering chains will improve plant stand population, by reducing air pockets in seed trench and stopping trench baking from the sun which will dry out moisture around seed.

1.1.6 Managing grass (cane, wheat) residue to facilitate soybean planting

Both grass and legume trash require careful management if the most is to be gained from a zonal/zero tillage system. However, if a few simple rules are followed, good establishment of either crop will be achieved. Both contribute a substantial amount of organic matter to the system and the legume contributes nitrogen.

Fresh cane trash in a green cane trash blanket system contains organic acids and other chemicals that can adversely affect soybean germination. To offset against poor germination and thus poor soybean establishment the fresh cane trash needs to be either raked away from the line where the soybean is to be planted or the soybean planting should be delayed for 4-6 weeks after cane harvest.

Another problem likely to arise will be nitrogen deficiency early in the life of the soybean crop. This is caused by the large amount of high carbon cane trash (often between 7-10 t/ha dry matter) immobilizing soil nitrogen. The addition of some starter N (20-30 kg/ha) will address this issue during the time prior to symbiotic nitrogen fixation commencing.⁶

1.1.7 Managing soybean residue to facilitate grass (cane, wheat) planting and to maximize the benefits of soybean

The amount of nitrogen contributed to the system by a soybean crop will depend on how the crop is managed—green manure or harvested for grain. With the latter, around 66% of the nitrogen in the crop will be removed with the grain. For example, a soybean crop producing 8 t/ha total dry matter at 3.5% nitrogen concentration will contain 280 kg/ha N. If the crop is harvested for grain 185 kg/ha will be removed with the grain leaving less than 100 kg/ha contributed to the soil. However, there will be a certain amount of nitrogen associated with the root system and rhizosphere. General assessments suggest this will be approximately 30% of what is contained in the above ground biomass. Thus, if the tops contain 280 kg/ha the amount in the rhizosphere and roots will be around 80 kg/ha, making a total for a harvested soybean crop in the order of 180 kg/ha. These figures, of course, will vary with the situation and the vigour of the soybean crop so they should only be treated as a guide.

How the soybean residue is managed will also have an important impact on nitrogen availability to the following crop. If the residue is incorporated, the nitrogen is mineralized very rapidly. Although this is generally accepted as a positive outcome, it can have negative effects with long-term crops such as sugarcane in high rainfall areas

⁵ Australian Oilseeds Federation (2013), Better Soybeans manual http://www.australianoilseeds.com/soy_australia/Soybean_Production

⁶ Australian Oilseeds Federation (2013), Better Soybeans manual http://www.australianoilseeds.com/soy_australia/Soybean_Production

where leaching can rapidly move nitrogen out of the root zone on permeable soils and de-nitrification can become a major source of N loss on heavier clay soils.

Surface managing the legume residue can slow the mineralization process and conserve the legume nitrogen later into the growing period of the following crop. Such a strategy fits very well into a zero tillage system. It can also have positive effects on the maintenance of soil water for the establishment of the following crop.⁷

1.2 Benefits of crop as a rotation crop

1.2.1 Soybean and their use in crop rotation

Crop rotation plays an important role in spreading risks associated with seasons and markets. As knowledge of the agronomic value of rotations increases – reducing disease severity, lowering the risks of herbicide resistance, controlling hard to kill weeds, reducing insect pressure, positively affecting soil physical properties, maintaining arbuscular mycorrhizae levels – their importance in sustainable cropping systems is more appreciated. Further, if the rotation crop is a legume the provision of symbiotically fixed nitrogen is an added bonus. Thus the ideal crop rotations involve broadleaf (legumes, canola, sunflower) and grass crops (maize, wheat, sugarcane). Being a broadleaf crop and legume, soybean is ideally suited for rotation with grass crops.

It is also important to consider both summer and winter crops when looking for rotation species. With major winter crops being the cereals, particularly wheat and barley, and soybean being a summer crop, it ideally suits as a rotation crop in many cropping areas. Further, a ‘double-crop’ rotation of soybean and wheat, for example, on an annual basis will improve cash flow and reduce overhead costs. Even if it is not possible to grow both crops on the same land in any one year, the growing of a summer and winter crop will spread the work load and better utilise machinery and labour resources.

Soybean offers a wide diversity in its use as a rotation crop. It can be used for forage, hay or silage, incorporated as a green manure or harvested for grain. Further, there are a number of market options for soybean grain.⁸

The introduction of soybean as a rotation crop in a sugarcane enterprise enables farmers to gain all the benefits of a green-manure legume crop in wet areas where only failures have occurred in the past. Economic modelling shows that a system including soybean fallows can produce improved gross margins over 100% cane throughout the whole crop cycle as well as improving soil health. There are also environmental benefits through reduced use of nitrogenous fertiliser due to the slower release of nitrogen from soybean residues and the reduced tillage after a soybean crop avoiding erosion losses following excessive aggressive tillage.⁹

Growing soybean as a rotation crop in sugarcane can help boost cane yields because there is a range of registered herbicide options which are available for weed control in soybean crops that are not suitable for use in sugarcane crops. Using these different herbicides gives cane growers a chance to reduce weed-seed populations by tackling some of the problem weeds in their paddocks, including volunteer cane.¹⁰

1.3 Fallow weed control

Don't let summer weeds seed for two years before planting summer crops. Ensure no residual chemicals are applied that will endanger soybean germination and production.

⁷ Australian Oilseeds Federation (2013), Better Soybeans manual http://www.australianoilseeds.com/soy-australia/Soybean_Production

⁸ Australian Oilseeds Federation (2013), Better Soybeans manual http://www.australianoilseeds.com/soy-australia/Soybean_Production

⁹ DR Sparkes and C Charleston, Adoption of Soybeans as a Rotation Crop in Far North Queensland: http://www.australianoilseeds.com/_data/assets/file/0013/1192/Catherine_Charleston-Adoption_of_Soybeans_as_a_Rotation_Crop_in_Far_North_Queensland.pdf

¹⁰ Weed control in soybean crops can be a valuable investment in your cane crop: http://www.sugarresearch.com.au/icms_docs/157925_Bulletin_Edition_36_2013_Weed_control_in_soybean_crops.pdf

1.4 Seedbed requirements

The preparation of a weed-free seedbed to allow rapid emergence is most critical.

To facilitate harvesting, the land should be free of sticks, stones and other obstacles. As soybeans set their lowest pods close to the ground, it is essential that the header front operates close enough to the ground to maximise grain yield without damaging the header.¹¹



Figure 3: A weed-free seedbed to allow rapid emergence is critical for good soybean establishment.

1.4.1 Soil pH, acidity and liming

Soybean is adapted to a wide range of soils from sands to heavy clays. The plant prefers a pH_{CaCl₂} in the range of 5.2-6.55. As pH levels drop below 5, increasing amounts of toxic aluminium and manganese can enter the soil solution. This effect is common in the coastal soils of NSW and is greatest in soils that are low in organic matter as indicated by an organic carbon soil test. For soybean, keep aluminium saturation levels less than 15% and manganese less than 20 mg/kg. If barley is also grown, depending on variety, keep aluminium saturation levels below 5% and manganese less than 50mg/kg. Soils with a pH_{CaCl₂} of 4.5 or less are unsuitable for growing soybean.

For example, many soils on the wet tropical coast of Queensland are marginal for soybean without the application of lime. However, most Burdekin district soils are primarily in the range of pH 6-8 while those in the Mackay district range from pH 5-6.5. Where the soil is acidic liming is an important consideration. However, it should only be carried out after a soil test indicates lime is needed. In sugarcane areas mill mud can be a valuable source of calcium and other nutrients.¹²

¹¹ M Bennett (2008), Soybean Production Recommendations for the NT: <http://www.nt.gov.au/d/Content/File/p/Crop/659.pdf>

¹² Australian Oilseeds Federation (2013), Better Soybeans manual http://www.australianoilseeds.com/soy_australia/Soybean_Production

1.4.2 Soil Salinity

Soybeans are intolerant of salt. Yield reductions occur at soil salinities greater than 2.0 dS/m and irrigation waters greater than 1.5 dS/m. Nodulation is impaired and plant growth is affected. Paddocks with known salinity problems should be avoided. Numerous Burdekin Delta farms in Queensland may have issues with soil salinity from saline irrigation (bore) water. This is usually less of an issue for summer crops (which are primarily rain grown), however, may be a significant issue for winter crops that are usually 100% irrigated.¹³

1.5 Soil moisture

1.5.1 Dryland

Soybeans must be sown into good soil moisture to ensure inoculant and seed survival. Soybean is a tropical legume so it requires adequate soil moisture especially in the establishment phase. The worst situation is when the seed is sown and starts to germinate but does not have adequate moisture to complete the process and establish a primary root down into moist soil. Seedlings direct drilled into stubble or sprayed out pasture cope better with hot dry conditions during establishment, which would be due to the moisture conservation aspects of the stubble coverage (compared with bare worked ground) and not varietal differences.

1.5.2 Irrigation

Soybeans are suited to a range of irrigation systems including raised beds, furrow, full flood and sprinkler irrigation. Regardless of the type of irrigation system, soybeans have a peak water demand during flowering and early pod filling.

In the subtropical and tropical coastal production regions, summer grown soybeans are usually grown on rainfall alone, however, irrigation (if available) is also used to supplement growth. Winter grown soybeans in the tropical north (e.g. Burdekin) rely almost fully on irrigation. High yielding soybeans receiving little or no rain typically use 6-8 ML of irrigation water/ha depending upon soil type, variety, paddock/irrigation layout and seasonal conditions.

In irrigated cropping systems (e.g. southern and central Queensland, northern inland and southern New South Wales and northern Victoria), the quantity of irrigations applied will vary depending on season, soil type and target yield. Implementing a scheduling system to help identify when the crop is approaching water stress is recommended.

Pre-irrigating fields one to three weeks prior to planting is recommended. This allows accurate planning of planting time, consolidation of the beds, planting into moisture and controlling weeds prior to planting. Watering up is possible but requires more care to ensure soils do not crust and weeds do not germinate at the same time as the crop. If watering up, particularly on heavy soils, plant at as shallow a depth as possible and only plant as much area as can be irrigated in a set.

¹³ Australian Oilseeds Federation (2013), Better Soybeans manual http://www.australianoilseeds.com/soy-australia/Soybean_Production



Figure 4: Young soybeans established in rice stubble on beds in bankless irrigation bays.

Grain yield and protein content are dependent on timely irrigations throughout the life of the crop, and avoiding moisture stresses. Mild moisture stress in the early vegetative stage has little impact on grain yield and can encourage the plant to seek moisture with a deeper root system. Intermittent moisture stress should be avoided as it may reduce grain protein content. When soybean plants start to become moisture stressed, they will firstly shutdown the nodules in the root system and will not activate them again until they receive adequate moisture. However, the delay between crop irrigation and fully functional rhizobia can be several days. The cumulative effect over the season can have a negative impact on the total nitrogen content within the plant and ultimately grain protein content.

As soybeans are often flowering and filling pods during the hottest part of the year, moisture stress can reduce yield by reducing the number of retained pods and by reducing seed weights.

It is critical that the plants do not experience moisture stress from the start of flowering, through pod development and filling to physiological maturity. For a crop planted in late November-early December in southern NSW, this means the peak water demand is from mid January to late March. This equates to 50–110 days after emergence. For a crop planted in mid-late December in north Queensland, the peak water demand is from mid February to early April. This equates to 50–110 days after emergence.

In terms of irrigation scheduling, it is not possible to make a definitive statement that will be appropriate for all soil types. Ideally some form of irrigation monitoring equipment (evaporation pans, enviroscans, etc) should be used to support irrigation decisions. Seek advice from an experienced local agronomist if in doubt.

The timing of the final irrigation is also critical, as it needs to be timed to ensure adequate water until physiological maturity yet not allow the field to remain too wet for harvest. Many growers stop irrigation too soon and lose valuable yield. As a very general guide, apply the final irrigation when the first maturing (pale yellow) leaves appear in the crop. Consider choosing a shorter-season (fast maturing) variety if one is

available for your region as this may reduce the number of irrigations required for the crop.¹⁴

1.5.3 Double crop options

Double cropping after soybeans is a common practice in the northern tablelands of NSW. Generally soybeans are planted early November and harvested in April which will allow enough time to crop back into a winter cereal crop in June. Double cropping from a cereal into a soybean crop is very risky, due to low moisture profile after winter crop cereal.

1.6 Nematode status of paddock

1.6.1 Effects of cropping history on nematode status

A field trial of three cropping histories (sugarcane, maize and soybean) and two tillage practices (conventional tillage and direct drill) on plantparasitic and free-living nematodes in the following sugarcane crop was conducted at Bundaberg, Queensland, in 2010. Soybean reduced populations of lesion nematode (*Pratylenchus zeae*) and root-knot nematode (*Meloidogyne javanica*) in comparison to previous crops of sugarcane or maize but increased populations of spiral nematode (*Helicotylenchus dihystera*) and maintained populations of dagger nematode (*Xiphinema elongatum*). However the effect of soybean on *P. zeae* and *M. javanica* was no longer apparent 15 weeks after planting sugarcane, while later in the season, populations of these nematodes following soybean were as high as or higher than maize or sugarcane. Populations of *P. zeae* were initially reduced by cultivation but due to strong resurgence tended to be higher in conventionally tilled than direct drilled plots at the end of the plant crop. Even greater tillage effects were observed with *M. javanica* and *X. elongatum*, as nematode populations were significantly higher in conventionally tilled than direct drilled plots late in the season. Populations of free-living nematodes in the upper 10 cm of soil were initially highest following soybean, but after 15, 35 and 59 weeks were lower than after sugarcane and contained fewer omnivorous and predatory nematodes.¹⁵ See Section 8–Nematodes for more information.

¹⁴ Australian Oilseeds Federation (2013), Better Soybeans manual http://www.australianoilseeds.com/soy_australia/Soybean_Production

¹⁵ GR Stirling, NV Halpin, MJ Bell and PW Moody (2010), Impact of tillage and residues from rotation crops on the nematode community in soil and surface mulch during the following sugarcane crop: <http://www.assct.com.au/media/pdfs/Ag%206%20Stirling.pdf>

SECTION 2

Pre-planting

More information

[GRDC 2013 New varieties for northern soybean growers](#)

[GRDC 2014 Australian soybeans come of age](#)

[GRDC 2015 Summer pulse agronomy including plant population row spacing varieties yields and nitrogen fixation](#)

[NSW DPI Summer crop production guide 2014](#)

2.1 Varietal performance and ratings yield

2.1.1 Variety selection

Well established soybean growing areas have a range of agronomically suitable varieties available for planting. Growers normally select a preferred variety according to planting window, disease resistance, maturity, yield potential and suitability for the target market.

The Australian Soybean Breeding Program (GRDC/CSIRO/NSW DPI) is ongoing. It is likely that new clear hilum varieties with improved yield, grain quality and broader regional adaptation will soon join the existing industry standards.

In terms of risk management, if a large area of soybean is planned, consider selecting varieties of different maturity to spread planting, maintenance and harvesting operations. In regions affected by *Phytophthora* it is also important that the industry does not become reliant on one variety only, as resistance to *Phytophthora* could break down through the occurrence of new races.¹

The soybean production regions of Australia cover a wide range of latitudes and climates. Thus, a range of varieties has been developed to suit these varied environments. To give your crop the best chance for success it is critical to select a variety that is recommended for your region and to sow it in the recommended planting window.

In addition to regional adaptation, processors in the human consumption sector of the market (e.g. soy milk, tofu, flour) are becoming more specific about the varieties they wish to use. The rapid expansion of this sector of the soybean market in Australia in the past decade has driven the change in soybean breeding toward clear (colourless) hilum varieties with larger seed size and higher protein to supply human consumption markets, in addition to the traditional crushing markets for oil and animal feed, which will accept varieties of any hilum colour.

In general terms, clear hilum varieties can supply all the market sectors provided that grain quality specifications are achieved by the grower. Dark hilum varieties are restricted to the crushing sector only, irrespective of grain quality.

If a large area of soybean crop is planned, consider selecting two of the varieties recommended for your region so as to spread the planting, maintenance and harvesting operations.²

2.1.2 Photoperiod

Soybean plants commence flowering and mature in response to increasing length of darkness (i.e. shorter number of daylight hours). Current commercial soybean varieties are photosensitive and in general the later they are sown in their recommended planting window the fewer days until flowering commences. Conversely, sowing a variety much earlier than its recommended window (or at latitudes much further south than its

¹ Australian Oilseeds Federation (2013), Better Soybeans manual http://www.australianoilseeds.com/soy-australia/Soybean_Production

² Australian Oilseeds Federation (2013), Better Soybeans manual http://www.australianoilseeds.com/soy-australia/Soybean_Production

zone of adaptation) can result in the crop spending too long in the vegetative phase and growing too tall and bulky. This can then lead to lodging and the development of fungal diseases (e.g. white mould caused by *Sclerotium rolfsii*), difficulty in harvesting the crop, increased chance of dirt in the sample and reduced grain quality. Bacterial blight may infect some varieties. Sowing too early is particularly risky in humid coastal environments.

Varieties sown later than their recommended sowing time (or at latitudes north of their zone of adaptation) will commence flowering very soon after planting and will likely have shorter plants with pods set closer to the ground.

Sowing in the early part of the recommended window is preferred where early growth is likely to be slower, such as where soil fertility is low, cool nights, or where crops are direct drilled.

The Australian Soybean Breeding Program has introduced breeding lines with reduced sensitivity to photoperiod, which will assist to broaden the north-south range of new varieties in the future.³

2.1.3 Regional adaption

Soybean has many varieties with specific ranges of adaptation. Planting a variety that is recommended for your region assists the crop to achieve maximum dry matter pre and post flowering, setting the crop up for maximum yield and assisting it to be fully mature at the correct time for harvest.

Varieties are also recommended for a region based on their tolerance to the particular diseases or environmental stresses of that region (e.g. acidic soil, weathering tolerance, lodging resistance, phytophthora, etc.). Many years of regional evaluation underpin the variety recommendations for Queensland, New South Wales and Victoria. Lists of the currently recommended varieties for the major soybean production regions are available through the agriculture departments in each state.

When varieties are sown outside their range of adaptation they are unlikely to perform to their best and optimum yield is unlikely.⁴

2.1.4 Southern NSW and Victoria

The main varieties suitable for southern NSW and northern Victoria are Curringa, Djakal, and Snowy.⁵

Curringa

Curringa superseded Bowyer for the premium human consumption, yellow hilum market. It had better yield, lodging and disease resistance than Bowyer. It is resistant to Phytophthora races 1 and 15, and has field tolerance to races 4 and 25. It has similar growth habit, maturity and seed size to Bowyer, but has higher yield potential in the MIA and Lachlan Valley. Curringa has been accepted into tofu and milk markets with similar processing quality to Bowyer. However, Curringa has a significantly lower yield and longer maturity than both Djakal and Snowy.⁶

³ Australian Oilseeds Federation (2013), Better Soybeans manual http://www.australianoilseeds.com/soy_australia/Soybean_Production

⁴ / Australian Oilseeds Federation (2013), Better Soybeans manual http://www.australianoilseeds.com/soy_australia/Soybean_Production

⁵ Australian Oilseeds Federation (2013), Better Soybeans manual http://www.australianoilseeds.com/soy_australia/Soybean_Production

⁶ Australian Oilseeds Federation (2013), Better Soybeans manual http://www.australianoilseeds.com/soy_australia/Soybean_Production

Djakal

Over the last six seasons at Leeton (mid November) Djakal has out-yielded Curringa by 20% and Snowy by 7%. On average it matured 11 days earlier than Curringa and six days earlier than Snowy. Djakal is suited to early season plantings in southern NSW irrigation areas only (no further north than the Lachlan Valley). Djakal is a strong performer, providing growers with consistent high yields, early maturity, lodging resistance and generally good agronomic package.

Djakal carries resistance to phytophthora races 1 and 4 but lacks resistance to the newer race 25, which is present in parts of the Riverina but is not widespread. Commercial experience indicates Djakal has field tolerance to race 25. Whilst this is a risk, good grower management can reduce the likelihood of this disease. Testing to date has shown Djakal to be equivalent to Curringa for tofu and soymilk. Protein content of Djakal is slightly lower than Curringa and Snowy.⁷

Snowy

Snowy is an early-mid maturing high yielding human consumption variety. It was the first clear hilum culinary quality soybean combining good tofu-making qualities with good agronomic traits.

Snowy is resistant to all commonly found races of phytophthora in the Riverina, including race 25.

Snowy has yielded about 7% less than Djakal, but significantly out-yields older varieties. It out-yields Curringa by 14% and has out yielded Empyle by 5%. It matures slightly later than Djakal, similar to Empyle, but notably earlier than Curringa. Snowy has slightly larger seed size and higher protein than Djakal and significantly larger seed size than Empyle. A premium may be available in the culinary market for this variety. Snowy is available from Soy Australia.⁸

2.1.5 Central NSW

The main varieties currently recommended for the Macquarie and Lachlan irrigation areas are Cowrie and Ivory.⁹

Cowrie

Cowrie was released in 2002 by NSW DPI for northern NSW, including rain-grown coastal and inland irrigation areas. It is a medium-quick maturing, group 5 type variety. It has a colourless (clear) hilum, good protein content and large seed size (approx. 23 g/100 seeds or 4350 seeds/kg), making it very acceptable to the soymilk, tofu and soyflour markets. Weathering tolerance is moderate (70% of Zeus). It is susceptible to phytophthora Race 15 but is resistant to Race 1. Due to its very early maturity in the Queensland production environment, Cowrie should be planted two or three weeks earlier than other varieties and no later than the first week of December in southern Queensland.¹⁰

Ivory

Bred by NSW DPI at Narrabri, Ivory is now being widely grown by irrigators in northern NSW from the Macquarie Valley north to the Queensland border.

It is a yellow hilum type, making it suitable for some segments of the human consumption trade as well as for crushing. It is a high yielding variety. Ivory is resistant

⁷ Australian Oilseeds Federation (2013), Better Soybeans manual http://www.australianoilseeds.com/soy_australia/Soybean_Production

⁸ Australian Oilseeds Federation (2013), Better Soybeans manual http://www.australianoilseeds.com/soy_australia/Soybean_Production

⁹ Australian Oilseeds Federation (2013), Better Soybeans manual http://www.australianoilseeds.com/soy_australia/Soybean_Production

¹⁰ Australian Oilseeds Federation (2013), Better Soybeans manual http://www.australianoilseeds.com/soy_australia/Soybean_Production

to races 1 and 4 of phytophthora with field tolerance to race 15. It also has resistance to bacterial pustule and bacterial blight. It is highly recommended for all irrigated and late dryland sowings.¹¹

2.1.6 NSW Northern Tablelands

The main varieties currently recommended on the Northern Tablelands are Moonbi, Richmond, Soya 791, Intrepid, Hale and Hayman for silage or hay.

Intrepid

Intrepid, bred by NSW DPI at Narrabri, is a dryland variety recommended for northern inland NSW. It has less tolerance to Phytophthora races 1 and 15 than Hale and Valiant. It has vigorous vegetative growth, making it a good competitor with weeds and it seems suited to minimum tillage. Its lowest pods are also slightly higher than Valiant and Hale. Intrepid is highly regarded by growers in this region.¹²

2.1.7 Northern NSW (dryland and irrigation)

The preferred varieties for the human consumption market are Moonbi, Ivory, Soya 791, Cowrie, Surf and Bunya. For crushing the main varieties are Hale, Valiant and Intrepid.

Hale

Hale was bred by NSW DPI at Narrabri, and released in 2000. It has improved yield potential and disease resistance. It has shown excellent yields under both irrigated and dryland conditions and has immunity to races 1, 4 and 15 of phytophthora.

In northern NSW, Hale has out-yielded Valiant under irrigated conditions by 8.5% averaged over nine trials and across six seasons. Its yield under dryland conditions is 2% higher than Valiant and 13.5% higher than Intrepid over six seasons of testing. Maturity, seed size, oil and protein content are very similar to Valiant.

Hale is the preferred variety for dryland situations. It is also promoted to irrigation cotton growers in northern river valleys as an early maturing alternative to the traditional full season varieties.¹³

2.1.8 NSW North Coast

Characteristics important for reliable production in these coastal environments and soils include:

- consistently high yield and grain protein content, above 40% (dry matter basis) for access to human consumption markets
- weathering tolerance at harvest
- good mature plant height (80–100cm) for the relevant sowing time without lodging
- tolerance to high soil manganese levels, common in soils with low pH and waterlogging
- tolerance to sclerotinia stem rot disease
- tolerance to downy mildew leaf disease
- tolerance to phytophthora root rot (not a common problem in the North Coast region to date).

Varieties currently recommended for the North Coast include Moonbi, Soya 791, Cowrie and Surf for human consumption markets and Zeus, Manta, Poseidon and A6785 for crushing markets. Varieties that are not recommended for the North Coast do not

¹¹ Australian Oilseeds Federation (2013), Better Soybeans manual http://www.australianoilseeds.com/soy_australia/Soybean_Production

¹² Australian Oilseeds Federation (2013), Better Soybeans manual http://www.australianoilseeds.com/soy_australia/Soybean_Production

¹³ Australian Oilseeds Federation (2013), Better Soybeans manual http://www.australianoilseeds.com/soy_australia/Soybean_Production

have all the traits desirable for coastal environments. If grown outside their region of adaptation, varieties recommended for other regions (e.g. Bunya and Warrigal, which are recommended for the inland production regions of Queensland and NSW) have a greater risk of not performing to their full potential.¹⁴

A6785

A6785 is a medium-maturing variety, group 6. Originally released by Asgrow, A6785 has a brown hilum, small seed size and moderate to high weathering tolerance. It is suited to soy flour and some soymilk manufacturing, although the seed size is smaller than this market prefers and protein is often below 40% dry matter. Some manufacturers are now tending towards varieties with a clear hilum and larger seed size and higher protein than A6785.

A6785 is resistant to the two main races of phytophthora root rot in Queensland. It can produce high yields if sown at the correct time and can tolerate less-than-ideal crop management.¹⁵

A6785 has a tendency to lodge in coastal climates, particularly if planted too early in the planting window or at too high a plant population.¹⁶

Hayman

Hayman sets a new benchmark for high yield, high quality and improved disease resistance for many areas. In some areas it is also the best variety for silage and hay – an important soybean role in many mixed grain and livestock farms. It is most suited for grain in the NSW north coast in the latest planting window (from the end of January to early February). At the early or mid-season planting windows it has too much biomass for a grain crop, but this is ideal where the objective is hay or silage production.

Hayman has improved protein content and quality, including clear hilum and large seed size. It also possesses the 11sA4 protein null (like Bunya) that is valued by tofu processors for its gelling qualities. Hayman is suitable for hay and silage production in the NSW north coast and Northern Tablelands areas because of its slower maturity and longer period of pod filling. This can be especially beneficial where delays due to wet weather are common.¹⁷

Manta

Manta was released in 1991 by NSW DPI for coastal environments. This variety combines high yield, tolerance to manganese, sclerotinia and race 1 of phytophthora. It also has a good level of weathering tolerance. Manta produces grain with above average protein content, but is only suitable for the crushing market due to its dark coloured hilum.¹⁸

Moonbi

Moonbi (Line 98053-3) is a variety from the Australian Soybean Breeding Program, available through Soy Australia. As a short season variety (ready to harvest 12 days earlier than Soya 791 from the same planting date), it is particularly suited to double cropping systems on the North Coast where timeliness of planting winter crops or pastures is critical. It is suited to the early season planting window on the North Coast from late November to early December. It also suits inland irrigated areas of northern

¹⁴ Australian Oilseeds Federation (2013), Better Soybeans manual http://www.australianoilseeds.com/soy_australia/Soybean_Production

¹⁵ Australian Oilseeds Federation (2013), Better Soybeans manual http://www.australianoilseeds.com/soy_australia/Soybean_Production

¹⁶ Australian Oilseeds Federation (2013), Better Soybeans manual http://www.australianoilseeds.com/soy_australia/Soybean_Production

¹⁷ GRDC (2014) Australian soybeans come of age: <http://www.grdc.com.au/Media-Centre/Ground-Cover/Ground-Cover-Issue-113-NovDec-2014/Australian-soybeans-come-of-age#sthash.vnggwGHJ.dpuf>

¹⁸ Australian Oilseeds Federation (2013), Better Soybeans manual http://www.australianoilseeds.com/soy_australia/Soybean_Production

NSW, where its short season will be beneficial in minimising irrigation requirements. It is likely to be adapted to production regions further south (e.g. Lachlan River valley) but further testing is required to confirm this.

Moonbi has excellent grain quality with a clear hilum, high protein, attractive round seed and better weathering tolerance than Cowrie and Soya 791. It is a compact plant with a much lower tendency to lodge than Soya 791. The grain quality is well suited for human consumption grade with its clear hilum making it suitable for use in the higher value tofu/soy milk markets. Seed size is around 22 g/100 seed or 4550 seeds/kg. Moonbi is resistant to powdery mildew.¹⁹

Poseidon

Poseidon was bred by NSW DPI for northern coastal NSW and released as a public variety in 1999 as a higher yielding replacement for Manta. Weathering tolerance and protein content are similar to Manta. Tolerance to Sclerotinia is less than in Manta. Poseidon has good tolerance to race 15 of Phytophthora. It has a black hilum, which makes it suitable only for the crushing market.²⁰

Richmond

Richmond is also a high-yielding release with a high-quality clear hilum that suits the early to mid-season planting window in northern NSW. It is a compact plant with minimal lodging, and has clean leaf drop and even ripening. It is resistant to powdery mildew, tolerates manganese toxicity, which is common in coastal soils, and has the highest weathering tolerance of all clear hilum varieties.²¹



Figure 1: During fields trials, Richmond (right) yielded an extra 0.2 t/ha compared to the popular Manta variety (left). (Photo: Natalie Moore)

¹⁹ Australian Oilseeds Federation (2013), Better Soybeans manual http://www.australianoilseeds.com/soy-australia/Soybean_Production

²⁰ Australian Oilseeds Federation (2013), Better Soybeans manual http://www.australianoilseeds.com/soy-australia/Soybean_Production

²¹ GRDC (2014) Australian soybeans come of age: <http://www.grdc.com.au/Media-Centre/Ground-Cover/Ground-Cover-Issue-113-NovDec-2014/Australian-soybeans-come-of-age#sthash.vnggwGHJ.dpuf>

Soya 791

Soya 791 is a medium-maturing public variety, group 5, released by Pioneer Hi-Bred under PBR and is available through a range of resellers. It has a buff hilum, good protein content and moderate weathering tolerance. Soya 791 is suitable for the flour, soymilk and tofu markets. It is not resistant to Race 15, one of the two main races of phytophthora root rot in Queensland.

The best time to plant Soya 791 is from November to mid-December. Delays to sowing may considerably shorten the crop height, reducing vegetative growth and so limiting yield potential and harvestability. Soya 791 is susceptible to both downy and powdery mildew.²² A variety evaluation trial was conducted on a farm at Oakwood near Bundaberg, Qld, in 2012-13. It has two replicates. That season was very conducive to bacterial blight (cool rainy weather during January). The varieties were scored for susceptibility to bacterial blight.

Key: 1 = no disease, clean leaves; 9 = severe disease all leaves affected.

The ratings were as follows:

Moonbi 2.5

Richmond 1.5

Soya 791 4

Surf

Surf is a medium-maturity variety, group 6, released for northern New South Wales from DPI&F material reselected by NSW DPI at Grafton. It has a clear hilum with moderate to high weathering tolerance. It is suited to soy flour and soymilk manufacturing. Surf appears to possess either high field tolerance or resistance to both the main races of phytophthora found in Queensland.²³

Zeus

Zeus was bred by NSW DPI for northern coastal NSW environments and was released in 1999 as a higher yielding and more weathering tolerant replacement for Dune. Zeus has the highest level of weathering tolerance of all the current commercially available varieties and useful tolerance to the fungus *Sclerotinia* (white mould), which makes it a popular choice for areas with high rainfall and high humidity. Zeus has a dark coloured hilum and is therefore suitable only for the crushing market. Zeus is susceptible to downy mildew.

2.1.9 Southern Queensland

Many varieties suitable for northern inland NSW can be successfully grown in southern Queensland. These include:

Bunya

Bunya is quick-maturity variety in most regions, group 5-6. Bred by CSIRO, Bunya was released in 2006 under PBR and is licensed to Soy Australia. It is well suited for southern Queensland. It is a large-seeded human-consumption type with a clear hilum. It is a preferred variety for tofu markets. Bunya is resistant to the two main races of phytophthora root rot in Queensland. The seed size of Bunya is very large, which can increase the risk of damage at harvest time. Germination checks and careful attention to seed-handling at planting is essential. Bunya is highly susceptible to powdery mildew.²⁴

²² Australian Oilseeds Federation (2013), Better Soybeans manual http://www.australianoilseeds.com/soy-australia/Soybean_Production

²³ Australian Oilseeds Federation (2013), Better Soybeans manual http://www.australianoilseeds.com/soy-australia/Soybean_Production

²⁴ Australian Oilseeds Federation (2013), Better Soybeans manual http://www.australianoilseeds.com/soy-australia/Soybean_Production

Fraser

Fraser is a slow-maturing variety, group 7, released by CSIRO in 2007 under PBR and is licensed to Soy Australia. It is suitable for southern Queensland from Gladstone to the New South Wales border. Fraser is a medium-seed size and is used in soy flour and soymilk manufacturing. It may also be used in tofu markets. Fraser is resistant to the two main races of phytophthora root rot in Queensland.²⁵

Hayman

Hayman sets a new benchmark for high yield, high quality and improved disease resistance for many areas. In some areas it is also the best variety for silage and hay – an important soybean role in many mixed grain and livestock farms. It is most suited for grain in areas such as the Darling Downs and Lockyer Valley, northwards to the Burnett and Mackay regions of Queensland. Hayman has improved protein content and quality, including clear hilum and large seed size. It also possesses the 11sA4 protein null (like Bunya) that is valued by tofu processors for its gelling qualities.²⁶

Jabiru

Jabiru is a slow-maturing variety, group 7, that was released by QDPI&F in 1998 under PBR and is licensed to PB Agrifoods. It has a buff hilum and good lodging resistance. It is suitable for flour milling and crushing. It is another of the older varieties that are still produced by some growers who retain seed, but has been largely superseded by newer varieties.

Jabiru has resistance or high tolerance to the two major races of phytophthora root rot found in Queensland.²⁷

Oakey

Oakey is a unique variety and suitable for the specialist natto-trade as well as other human-consumption markets. It was developed by CSD and CSIRO and operates in a closed loop marketing system. It is widely adapted from southern to central Queensland and is a tall determinant plant with a medium-slow maturity.²⁸

Richmond

Richmond is also a high-yielding release with a high-quality clear hilum that suits the early to mid-season planting window in southern Queensland. It is a compact plant with minimal lodging, and has clean leaf drop and even ripening. It is resistant to powdery mildew, tolerates manganese toxicity, which is common in coastal soils, and has the highest weathering tolerance of all clear hilum varieties.²⁹

Warrigal

Warrigal is a slow-maturing variety, group 7, developed by DPI&F and released in 1992 under PBR. It is licensed to Pacific Seeds, and is marketed by PB Agrifoods. It has a clear hilum with moderate weathering tolerance. It is suited to soy flour and soymilk manufacturing although the seed is smaller than this market prefers.³⁰

²⁵ Australian Oilseeds Federation (2013), Better Soybeans manual http://www.australianoilseeds.com/soy_australia/Soybean_Production

²⁶ GRDC (2014) Australian soybeans come of age: <http://www.grdc.com.au/Media-Centre/Ground-Cover/Ground-Cover-Issue-113-NovDec-2014/Australian-soybeans-come-of-age#sthash.vnggwGHJ.dpuf>

²⁷ Australian Oilseeds Federation (2013), Better Soybeans manual http://www.australianoilseeds.com/soy_australia/Soybean_Production

²⁸ Australian Oilseeds Federation (2013), Better Soybeans manual http://www.australianoilseeds.com/soy_australia/Soybean_Production

²⁹ GRDC (2014) Australian soybeans come of age: <http://www.grdc.com.au/Media-Centre/Ground-Cover/Ground-Cover-Issue-113-NovDec-2014/Australian-soybeans-come-of-age#sthash.vnggwGHJ.dpuf>

³⁰ Australian Oilseeds Federation (2013), Better Soybeans manual http://www.australianoilseeds.com/soy_australia/Soybean_Production

2.1.10 Tropical Queensland

Leichhardt

Leichhardt is a slow-maturing variety, group 9, suited to northern and coastal Queensland. Its growing season is approximately 10 days longer than the Stuart variety when grown during the wet season. In southern coastal regions, plant Leichhardt later than the local shorter duration varieties to restrict vegetative growth. Leichhardt is generally not recommended as a human-consumption type but quite acceptable for crushing.³¹

Stuart

Stuart is a long-duration variety adapted to the tropics, group 8-9. Stuart was released by CSIRO in 2006 under PBR, it is licensed to Soy Australia and is produced by North Queensland Tropical Seeds. It is the first, light-coloured hilum variety suited to coastal and tropical Queensland. Stuart is a slow-maturing variety and should not be planted in areas south of Mackay. It is also adapted to dry season planting in the tropics. If sown at the correct time, Stuart is slightly less vegetative than Leichhardt. In rotation with sugarcane, this variety has the advantage of higher resistance to root nematodes than other soybean varieties. It also has resistance to the current rust races causing problems in cool, wet years on the Atherton Tableland.³²

2.1.11 Yielding ability

[Summer pulse agronomy including plant population row spacing varieties yields and nitrogen fixation.](#)

FAQ 2.2 Planting seed quality

Soybean seeds are relatively short-lived and even when produced under optimum conditions can lose germination and vigour after a few months in storage. Obtain a reliable germination and vigour test after harvest to make sure seed is worth keeping and test it again 4–8 weeks before sowing to ensure it has not deteriorated.

Prolonged wet weather before harvest reduces seed quality by the alternate wetting and drying of seed in the pods. Seed with high moisture levels will lose germination capacity after only a few months storage. Seeds have only a thin seedcoat, making them more susceptible to damage than other crop species. Incorrect seed handling, the use of spiral augers, and long drops of seed onto hard surfaces will damage the thin seedcoat. Larger seeded types, grown for human consumption markets, are at greater risk of mechanical damage than the smaller-seeded crushing types.³³ Only keep seed with an after harvest germination test of more than 90% to plant the next crop. Consider purchasing industry approved seed from suppliers at least every three years.

2.2.1 Seed size

Seed size can vary considerably so adjust the seeding rate accordingly. Refer to the seed packaging label for an accurate count, usually around 5000 to 7000 seeds/kg for most varieties.³⁴

2.2.2 Seed storage

Soybean seed is very fragile and cannot cope with seed coat damage. The use of spiral augers is not recommended and belt shifters or vacuums are much gentler on seed.

³¹ Australian Oilseeds Federation (2013), Better Soybeans manual http://www.australianoilseeds.com/soy_australia/Soybean_Production

³² Australian Oilseeds Federation (2013), Better Soybeans manual http://www.australianoilseeds.com/soy_australia/Soybean_Production

³³ NSW Soybean Grower Guidelines: http://www.australianoilseeds.com/_data/assets/pdf_file/0009/7668/Inland_NSW_Soybean_Grower_Guidelines.pdf

³⁴ Qld DAF, Growing soybeans: <https://www.daf.qld.gov.au/plants/field-crops-and-pastures/broadacre-field-crops/soybeans/growing-guide>

Even though beans should be harvested at 15% moisture content to minimise seed damage, the seed should be stored at below 13% and preferably at 10% moisture content and kept cool to maintain viability.³⁵

2.2.3 Safe rates of fertiliser sown with the seed

MAP is generally used as the planting fertiliser.

It is concentrated (21.9% P) and has high water solubility.

It contains 10% nitrogen (N) in the ammonium form.

The small amount of nitrogen it supplies can help meet crop demands for nitrogen up to the time the crop's root system is properly nodulated, i.e. supply starter nitrogen during the first few weeks after planting.

The combination of positively charged ammonium ions (NH₄⁺) with negatively charged phosphate ions (H₂PO₄⁻) may also help promote root uptake of the latter.

This may be of importance in tap rooted crops such as soybean, that may not take up phosphorus from fertiliser bands as effectively as fibrous rooted cereal crops.

The nitrogen in MAP may become of concern if the planter is not set up to apply the fertiliser and seed through separate delivery hoses (i.e. they are placed in direct contact with each other in the soil).

This should not be of concern at narrow row spacings (e.g. 20 cm) at the rates at which phosphorus (and MAP) are typically used.

In row crops planted in one metre rows, the suggested maximum rate at which MAP is used at planting in direct contact with the seed under good moisture conditions is 50 kg/ha. This rate should be reduced on loams.³⁶

³⁵ Agriculture Victoria, Growing Soybean: <http://agriculture.vic.gov.au/agriculture/grains-and-other-crops/crop-production/growing-soybean>

³⁶ Incitec Pivot Limited, <http://www.incitecpivot.com.au/>

SECTION 3

Planting

FAQ 3.1 Inoculation

Soybeans do not need additional nitrogen if the seed is effectively inoculated at planting with the correct strain of nitrogen-fixing rhizobia. Inoculum is a mixture of the sensitive living bacteria (rhizobia) that can be supplied to seed in a peat culture, in a clay granule or even as freeze dried spores. Inoculation of soybean seed with Rhizobia helps maximise nodulation and N-fixing ability. Effective nodulation also maximises the residual nitrogen carryover for the following crop (at least 40–60 kg N/ha in a harvested crop, and possibly as high as 120 kg N/ha).¹



Figure 1: Effective inoculation is essential for good nodulation. (Photo: Australian Oilseeds Federation)

If soybean seed is effectively inoculated with the correct strain of the nitrogen-fixing rhizobia at sowing, the plants rarely need any additional nitrogen (N) at planting or during the crop as they have the ability to fix far more nitrogen from the atmosphere than they require to grow. Soybean plants have a high nitrogen requirement, but when inoculated correctly will fix more nitrogen than their own needs.

Soybean inoculum is a living bacterium (*Rhizobium*) mixed in a peat culture or other medium. Correct inoculation enables the bacteria and the soybean root to form nodules, which are essential for fixing nitrogen from the atmosphere. Inoculation of every soybean crop is recommended as the bacteria that facilitate the nodulation process are largely absent in Australian soils, especially soils that have not recently grown soybeans or that have been waterlogged. Poor inoculation or avoiding inoculation will not save

¹ Australian Oilseeds Federation (2013), Better Soybeans manual http://www.australianoilseeds.com/soy_australia/Soybean_Production

money as poor nodulation and reduced N fixation will have a negative effect on crop vigour, grain yield and protein content and the profitability of the crop.

Adding a small amount of starter N (up to 20 kg N/ha) may help if large amounts of organic matter (such as cane trash) have been incorporated prior to sowing soybean but care must be taken not to add too much starter N as this will interfere with timely nodulation of the crop. While additional nitrogen application may produce taller, greener looking plants, trial results to date show no economic yield response from the addition of nitrogenous fertiliser to soybeans in dryland situations. It is far more cost effective to inoculate the seed correctly at planting time than to supply additional N fertiliser during the crop.

The *Rhizobium* strain specific to soybeans is the Group-H *Rhizobium* strain CB 1809. Refer to the container label for inoculant application rates and check the expiry date. Do not use inoculum if the expiry date has passed or if it has not been stored correctly. Rhizobia are living organisms and the number of live cells will decrease rapidly in hot, dry conditions. Store refrigerated (but not frozen). In the paddock situation, store inoculant in an esky with ice to keep it cool but not frozen. Likewise, after the seed is inoculated it should be kept in a cool shady place out of direct sunlight and planted as soon as possible after inoculation. Due to high summer temperatures, ideally only treat enough seed to plant a small area at a time. Do not inoculate large quantities of seed prior to planting and leave standing outside in high temperatures.

Exercise caution when using air seeders, as hot air in the distribution system of some air seeders (e.g. older style air seeders with the oil cooler in front of the air intake) can kill the inoculum. Temperatures greater than 30°C can kill rhizobia.

Methods of inoculation vary, but in general the better the job is done, the more effective the nodulation and the more nitrogen the crop can fix. Methods include:

- slurry inoculation
- water injection and in-furrow sprays
- pelleted seed
- Nodulator[®] granules²

3.1.1 Slurry inoculation

This is the most common form of inoculation and is also the most reliable and effective. The peat inoculant is mixed with cool water to make a slurry, which is then gently mixed to evenly coat the seed (follow label instructions for mixing rates—do not use too much water). Cement mixers are sometimes used for mixing seed with the inoculum slurry provided that care is taken to avoid seed damage (e.g. bouncing seed off metal can crack the seed coat—avoid excessive agitation). Do not use augers. Slurry inoculated seed should be sown within 2 hours of treatment, however, if stored properly (5°C or lower and out of direct sunlight) can be kept for longer (no more than 12 hours), provided a peat inoculum and sticker have been used. Remember the inoculant is a living organism and will commence dying almost immediately, especially if not treated correctly.³

3.1.2 Water injection and in-furrow sprays

For this method place a band of inoculum suspended in water, just below the seed in the furrow at planting. When germinating seed roots grow through the band of inoculum in the soil, nodules can form. The results from this form of inoculation are generally good, except where the seedbed is very dry or the water jet is not directed properly. Water rates vary according to row spacing, but use at least 300 L/ha. A continuous flow of water from each outlet, without blockages, is essential. Conventional water injection

² Australian Oilseeds Federation (2013), Better Soybeans manual http://www.australianoilseeds.com/soy_australia/Soybean_Production

³ Australian Oilseeds Federation (2013), Better Soybeans manual http://www.australianoilseeds.com/soy_australia/Soybean_Production

equipment is suitable for this inoculation method. This method can save time if sowing large areas.⁴

3.1.3 Pelleted seed

This method is offered by some commercial seed companies. Seed can be pre-pelleted with inoculum as well as fertiliser, insecticides, or fungicides. Pelleting increases the bulk of the seed, therefore appropriate adjustments need to be made to planting rates. This procedure is expensive and is not always effective for living inoculum due to the time delay between pelleting and planting. Proper application and storage techniques are vital to ensure survival of the *Rhizobium*. Do not lime coat the seed after inoculating as this will adversely affect the *Rhizobium*.⁵

3.1.4 Nodulator® granules

This is a clay-based granular inoculant released in 2007. It can be placed straight into sowing equipment provided an appropriate box is available (e.g. seeders with separate additional seed boxes or granular insecticide boxes). Placement should be as close as possible to the seed in the furrow to allow maximum contact between the granule and the seedling roots.⁶

3.1.5 Rhizobia, molybdenum and checking nodules

Rhizobia are extremely fragile; hence fertilisers, insecticides, fungicides should not be mixed with inoculum or inoculated seed as many pesticides are toxic to rhizobia.

Molybdenum (Mo) is essential for the nodules to function in the nitrogen-fixation process. Adding fertiliser containing Mo (typically Mo Super) can aid the efficiency of N-fixation in legumes especially when soil deficiencies exist and the soil is acidic (pH CaCl_2 less than 6). Alternatively, molybdenum trioxide can be applied at a rate of 50 g/ha.

To establish if nodules are functioning, growers are encouraged to dig up plants during the season to check on the success of their inoculation procedures. Check several locations within the crop. Carefully dig up a group of plants that are at least four weeks old, wash the root systems and cut open several nodules. Functioning nodules should be large, firm and white on the outside with a pink – orange colour on the inside (Figure 2). Nodules that are very small in size, or that have a green, grey or white colour inside are not functional and you should seek the advice of your local agronomist.



Figure 2: Functional soybean nodules should be large, firm and white on the outside (left) and have a pink – orange colour on the inside (right). Soybean growers are encouraged to dig up some plants in every crop to check that nodules have formed correctly. (Photos: N. Moore, NSW DPI).

⁴ Australian Oilseeds Federation (2013), Better Soybeans manual http://www.australianoilseeds.com/soy_australia/Soybean_Production

⁵ Australian Oilseeds Federation (2013), Better Soybeans manual http://www.australianoilseeds.com/soy_australia/Soybean_Production

⁶ Australian Oilseeds Federation (2013), Better Soybeans manual http://www.australianoilseeds.com/soy_australia/Soybean_Production

Environmental conditions such as hot, dry weather at planting can kill the *Rhizobium* bacteria before they come in contact with the plant roots. This is one of the primary reasons why soybeans must be planted into moist soil or irrigated immediately as planting dry and waiting for rain increases the risk that the bacteria will die before the seed can germinate. Accordingly, in irrigated districts, only plant as much as can be irrigated in a set. Considering that temperatures of over 50°C have been recorded in surface layers of black soil in summer, planting into these conditions carries a degree of risk in terms of inoculant survival. Consider planting very early in the morning or later at night when soil temperatures are cooler to reduce mortality of the rhizobia.

During the growing period, rhizobia can die if the roots become waterlogged. However, soybeans have remarkable tolerance to waterlogging, especially if grown on raised beds that allow the root zone to drain and maintain some aeration. Careful field selection and improvements to drainage are critical to ensure adequate nodulation and N-fixation as well as good root growth. Consider growing soybeans on raised beds or hills in fields prone to waterlogging.⁷

3.2 Time of sowing

Sowing windows and varieties vary widely across the soybean production regions of Australia. Consult your local agriculture department or crop agronomist to obtain the recommended sowing times and varieties for your region. If you choose to sow a variety outside its recommended window it is very unlikely to reach full yield potential.⁸

3.2.1 New South Wales and northern Victoria

In northern Victoria aim to sow from early November to mid-December while in southern NSW sow from mid-November to mid-December so crops can mature as early as possible, preferably by late March/early April. Sowing in these windows maximises plant dry matter pre and post flowering, setting the crop up for maximum yield. Planting in late December (after 25 December) shortens the growing season and reduces total plant dry matter considerably, resulting in the plants maturing in cooler overnight temperatures which delays harvest and reduces yields. It also reduces the flexibility in the timeliness of farming operations, and often crops are exposed to greater insect pressure. Planting in early January in southern NSW is not recommended.

In northern inland NSW the planting window for maximum yield potential commences in mid November. Yield potential declines with late plantings. The critical cut-off date varies from mid December in the Macquarie and Namoi Valleys and tablelands, to late December in the irrigated border areas. By mid January yield potential declines by 30% and other crops are preferred.

In the Manning, Hastings and Macleay Valleys, the recommended sowing times range from early November to the end of December.

In the North Coast districts of NSW, current varieties allow sowing in three planting windows from late November to about 20 January, with different varieties servicing each window (refer to the NSW DPI Summer Crop Production Guide for the latest variety and planting time recommendations).⁹

3.2.2 Queensland southern and inland

December is the preferred planting time in southern Queensland. For central Queensland, mid to slow-maturing types are the most suitable. Crops planted in mid-December mature from 115-125 days. To avoid problems with excessive vegetative growth from early plantings, earlier maturity varieties such as Soya 791 are the best

⁷ Australian Oilseeds Federation (2013), Better Soybeans manual http://www.australianoilseeds.com/soy-australia/Soybean_Production

⁸ Australian Oilseeds Federation (2013), Better Soybeans manual http://www.australianoilseeds.com/soy-australia/Soybean_Production

⁹ Australian Oilseeds Federation (2013), Better Soybeans manual http://www.australianoilseeds.com/soy-australia/Soybean_Production

choice in this region. Conversely, late maturing varieties such as Stuart are a better option for late plantings in this region because they will help extend the length of the vegetative phase, which has a strong correlation with potential yield.

Avoid planting any variety after the third week in January otherwise growth, stature and crop yield are likely to be restricted. Leichhardt is the latest sowing option and will extend a couple of weeks longer in warmer situations but is not a preferred option in inland production areas.¹⁰

3.2.3 Queensland central and north coastal

For summer planting, mid-late December is the preferred planting time in central/northern Queensland. Variety Stuart matures around 2 weeks earlier than Leichhardt. Typically, Leichhardt planted in mid December will be ready for harvest around mid May (around 150 days), whereas Stuart will be 2 weeks earlier (around 135 days).

The ideal time to plant summer grown soybeans intended for grain production is mid December–early January. Planting earlier than this will result in tall crops that often lodge, making insect control and harvesting more difficult. Very early plantings are best confined to green manure crops.

For autumn/winter planting, both Leichhardt and Stuart can be successfully grown over the late autumn/winter in the Burdekin. Plant size and hence yield potential is generally lower than that of a summer planted crop because of the reduced temperature and consequent heat units. One major advantage of autumn/winter soybeans is that pest pressure is usually lower. Additionally the likelihood of rain at harvest is generally low in most years.

Leichhardt and Stuart can successfully be planted through summer and then in late autumn/early winter (up to 30 June). The ideal time to plant dry season soybeans is from early May–June 30. Plantings at the start of this window (May) will generally yield better than late June plantings, particularly in cooler winters. Do not plant soybeans after 30 June because the combination of day length and temperature may result in a commercial failure as a grain crop. Late plantings into autumn and winter are obviously not suited to frost-prone areas.¹¹

FAQ 3.3 Targeted plant population

Recommended plant population for soybean varies widely depending on region and sowing time. Consult your local agronomist for the recommended plant population for your region and farming system. When the planting rate is higher than recommended for the planting conditions, individual plants become crowded. Over-crowding of soybean can result in:

- Fewer branches and fewer pods produced per branch and fewer pods developed at lower nodes.
- Plants growing tall, thin and producing weaker stems—causing lodging.
- Greater risk of disease development (e.g. *Sclerotinia* or white mould fungus, which favours humid, dense or lodged soybean crops). White mould disease can lead to further lodging and unfilled pods as the infection rots the stem.
- Difficulties in applying crop protection products like insecticides.
- Difficulties in harvesting a lodged crop and a higher risk of picking up soil that can reduce the quality of the grain and reduced access to higher value markets.

Higher than recommended sowing rates can therefore be costly due to the extra seed, lost returns in lower yield, harvesting difficulties and reduced grain quality.

¹⁰ Australian Oilseeds Federation (2013), Better Soybeans manual http://www.australianoilseeds.com/soy_australia/Soybean_Production

¹¹ Australian Oilseeds Federation (2013), Better Soybeans manual http://www.australianoilseeds.com/soy_australia/Soybean_Production

For New South Wales the target plant populations for the major production regions are listed in Table 1 below. Note that lower plant populations are preferred when sowing is early in the recommended window, while the higher densities are preferred for sowing later in the recommended sowing window.

Table 1: Target plant populations for soybean in New South Wales

Production Region of NSW	Target Plant Population— established plants/m ²
NSW Northern Inland	
Irrigation/mild dryland areas	25–30
Dryland/Slopes and Plains	15–20
Tablelands	35–40
NSW Coastal	
Narrow rows (< 75cm)	30–40
Wide rows (> 75cm)	28–32
NSW Southern	
Mid Nov–Mid Dec	30–35
Mid Dec–Late Dec	35–45

For Queensland, summer plantings in coastal Queensland (Bundaberg, Mackay, Burdekin districts), aim for plant populations of 250,000-300,000 plants/ha. Anecdotal evidence would suggest that the extremely vigorous growing conditions of the Burdekin may allow the plant population to be reduced to 200,000-250,000 plants/ha to limit lodging. Do not use high plant populations under summer tropical conditions as lodging commonly occurs, resulting in difficulties with insect control from poor spray penetration and greater risk of fungal diseases such as white mould (*Sclerotium rolfsii*). For autumn/winter in the Burdekin, increase this population to 400,000–500,000 plants/ha. With autumn/winter planting, plants will not grow as large. Always use the highest recommended population if sowing at the end of the planting window (late June).¹²

3.4 Calculating seed requirements

As seed size can vary considerably between varieties and between seasons, you must adjust the seeding rate accordingly to avoid over or under planting. Refer to the seed packaging label for an accurate seed count (number of seeds per kg). All seed offered for sale must clearly state the germination percentage. Use the best quality seed available. It is not recommended to use seed lower than 85% germination. Increasing the seeding rate to compensate for low germination seed is risky as low germination seed commonly also has low vigour.

To calculate your planting rate you will need to know:

- the targeted plant population for your region—get this from your local agronomist (the example below uses 250,000 plants/ha)
- a seed germination test result (%)—this should come with the planting seed (the example below uses 92%)
- number of seeds per kg for the variety to be planted—this should be stated on the bag of planting seed (in this example the variety has 6,400 seeds/kg),
- establishment rate of the germinative seed (assume 85%). Use one of the following formula to calculate sowing rates:

¹² Australian Oilseeds Federation (2013), Better Soybeans manual http://www.australianoilseeds.com/soy-australia/Soybean_Production

Formula to calculate sowing rate (kg/ha) =

$$\frac{\text{targeted plant population (plants/ha)} \times 100}{(\text{seed germination \%}) \times (\text{establishment rate \%})} \text{ seeds/kg}$$

Worked example:

$$\frac{250,000 \times 100 \times 100}{(92 \%) \times (85 \%) \times 6400} = 50 \text{ kg per ha}$$

What does this equate to in terms of seeds per linear m of row?

Formula to calculate seeds to drop per linear m of row =

$$\frac{\text{row spacing (m)} \times \text{targeted plant population (plants/ha)}}{(\text{seed germination \%}) \times (\text{establishment rate \% of germinative seed})}$$

For example, for a row spacing of 0.75m:

Seeds per linear m of row = $(0.75 \times 250,000) / (92 \times 85) = 24$ seeds per metre of row¹³

3.4.1 Establishment percentage

Soybean can sometimes have variable and poor establishment, however 80% to 90% establishment is achievable in friable non-crusting soils, using fresh, high quality seed. While poor seedbed environment can contribute to poor establishment, poor seed quality is often more likely to be the cause. Using low quality seed is a primary reason for soybean's reputation as a difficult germinator.

The accelerated ageing test is an internationally accepted method of assessing seed vigour in soybeans, and is now available in Australia. It should be used in conjunction with the standard germination test. For further details contact SGS Agritech, 214 McDougall St, Toowoomba, Qld 4350 or phone 07-4633 0599.

Be sure to:

- strongly consider purchasing industry approved seed from suppliers with a current (<3 months) germination certificate
- treat seed carefully and avoid dropping bags onto the ground

If you choose to use seed from other sources:

- avoid planting seed with hairline cracks in the seed coat. This usually indicates mechanical damage.
- avoid using seed damaged by pod sucking insects (e.g. green vegetable bug)
- avoid using old seed
- avoid using seed with any sign of mould or weather damage
- the only long term storage conditions recommended for soybeans in the tropics are low humidity refrigeration.

If in doubt, check the rate of emergence of a small quantity of seed in soil prior to planting the crop.¹⁴

FAQ

3.4.2 Row spacing and configuration

Soybean has a large seed size relative to other crops and a delicate, thin seed coat. It is, therefore, not suitable to broadcast through a spreader and be disced in. Soybean is best grown in defined rows using a seeder to achieve uniform seed depth and placement along the row. Row cropping allows more options for weed control including the use of banded sprays, shielded sprayers and inter-row cultivation. It also facilitates the use of directed sprays for insect control and aeration of the crop, which is

¹³ Australian Oilseeds Federation (2013), Better Soybeans manual http://www.australianoilseeds.com/soy_australia/Soybean_Production

¹⁴ Australian Oilseeds Federation (2013), Better Soybeans manual http://www.australianoilseeds.com/soy_australia/Soybean_Production

particularly important to minimise the development of fungal diseases such as leaf rust and Sclerotinia in humid environments.¹⁵

Dryland

For dryland (rainfed) crops on the slopes and plains of northern New South Wales a wide row spacing of 100 cm is suggested to help conserve moisture for pod-fill. However, in potentially higher yielding situations row spacing should be narrowed to 75 cm or less.

In the more favoured rainfall areas of the Northern Tablelands and North Coast of New South Wales, crops are normally planted at 18–53 cm row spacing. Wider rows are acceptable provided complete canopy closure is achieved by early-mid flowering and weed control is adequate. Narrow rows are preferred when planting late or where weeds are likely to be a problem as the crop canopy closes more quickly.

In cultivated seedbeds, seed is generally sown in 18 or 36 cm row spacings using conventional seed drills. With minimum- or no-till systems, specialised direct drills (preferably disc openers) or precision planters are necessary to ensure uniform seed placement and clearance of pasture residue or crop stubble.¹⁶

Irrigated

In irrigated cotton rotations in northern New South Wales soybeans are planted on a row spacing of 100 cm to suit row spacing used in the cotton farming system. However, grower experience suggests that soybean yields can be up to 10–20% higher using a narrower row spacing of 50 cm.

In southern NSW irrigation areas the industry standard configuration is 1.8 m raised beds (furrow to furrow) with two rows of soybean planted on the top of each bed (90 cm row spacing). However, row spacing can range from 30 cm to 90 cm depending on the farming system, stubble loads, time of sowing and inter-row sowing capability. Sowing a single row of soybean in the middle of the raised bed is only suitable on soils with very good lateral water movement. Sowing more than two rows per bed requires more water (to fill to the middle of the bed to field capacity) where the centre row will be located.

Irrigated soybeans grown on raised beds produce higher and more consistent yields than soybeans planted on a border check layout. In the Riverina region of NSW, soybeans are typically grown on raised beds using furrow irrigation on slopes of 1:1500 or flatter with run lengths of 400–800 m. This allows better drainage around the root zone, less water-logging problems (i.e. potential disease build-up) and minimal establishment difficulties. Raised beds facilitate the sowing of soybeans into a moist seedbed for successful and timely crop establishment.

Border check layouts often have establishment problems, due to difficulties achieving a moist soil suitable for sowing but that is not too wet to drive on. Often the soil surface dries out too quickly before, during and after sowing resulting in uneven and low plant population and patchy crop establishment.

On raised beds, paddocks ideally should be pre-watered one to three weeks before planting and sown as soon as soil is dry enough to work. This strategy is best used when sowing into fallow. Watering up (double-cropping strategy on raised beds) once soybeans are planted is possible if the soils are uniform, and beds are high and well consolidated. Seed must be lightly covered with soil and the seed line must remain above the furrow water level. When double cropping on raised beds, most growers remove a large proportion of the winter stubble prior to sowing by baling or burning, for example. This allows better water flow down the furrows without the stubble blocking the water.

¹⁵ Australian Oilseeds Federation (2013), Better Soybeans manual http://www.australianoilseeds.com/soy_australia/Soybean_Production

¹⁶ Australian Oilseeds Federation (2013), Better Soybeans manual http://www.australianoilseeds.com/soy_australia/Soybean_Production

Watering up on border check is not recommended as the seed can drown and/or burst due to lack of drainage. Watering up is also not recommended for first time soybean paddocks, as inoculant rhizobia can die in the hot, dry soil before water can be applied. Achieving an even plant stand with the correct plant population is the cornerstone of a high yielding crop.

Pressurised water systems (pivots and laterals) are increasing in number in southern NSW. This provides a very flexible system for soybean growers. Best strategies are to pre-water (for both single and double cropping) and then sow into a moist seedbed. Often growers will apply a light watering post-sowing to ensure even emergence. In double cropping, many growers are inter-row sowing and on skip rows to achieve a wider row spacing for the soybeans (e.g. wheat on 30 cm and soybean on 60 cm as illustrated in Figure 3). Stubble removal is not required in these systems and is considered highly beneficial to reducing soil water evaporation and water use by the crop.¹⁷



Figure 3: Soybean growing between wheat stubble in an irrigated, raised bed system in southern NSW. (Photo: L. Gaynor, NSW DPI.)

Tropical Queensland cane systems

Due to the relatively short summer days of the Queensland tropics, the wide (1 m) row spacing of the southern cropping systems will usually result in reduced yield compared with narrower row spacing of <75 cm. In North Queensland there is some flexibility in row spacing. Row spacings from 45-75 cm are common and similar yields have been achieved when planted within this range. Row spacing decisions will normally be dictated by bed sizes and previous cane row configuration.

The ideal row spacing in the coastal tropics of Queensland is 50–75 cm. A 75 cm row spacing fits well with the standard sugarcane system which uses a 1.5–1.6 m row. With

¹⁷ Australian Oilseeds Federation (2013), Better Soybeans manual http://www.australianoilseeds.com/soy_australia/Soybean_Production

GPS now commonly used in the industry, it allows planting cane between the two rows of soybean with minimal requirements to cultivate.¹⁸

3.5 Sowing depth

It is very important to plant soybean seed at the correct depth. In general, soybean seed should be sown into moist soil as shallow as possible whilst allowing maximum contact between the seed and moist soil.

In dryland (rainfed) situations aim to place seed at a depth of no more than 5 cm. Where soil moisture is deeper than this, drilling to 7.5 cm has been successful but emergence can be poor, particularly if heavy rain causes the soil to pack or crust before seedlings emerge. Restrict seed depth to around 3 cm on medium clay soils, up to 5 cm on light sands and 2.5 cm on heavy clays or hard-setting soils. In irrigated situations shallower sowing (2–3 cm) is preferred, especially if crops are sown dry and watered up.

The use of rollers or heavy press-wheels that press soil directly over the seed row after planting is generally not advised. Planters with press wheels that press the soil onto the sides of the seeds whilst leaving a crown of uncompacted soil for easy seedling emergence are preferred.

It is best to avoid planting if heavy storms are forecast within 24 hours of sowing. This is often difficult in the tropics but growers should consider this when making a decision to plant. Waterlogging or over irrigation immediately after sowing is not conducive to germination and usually results in patchy crop establishment.¹⁹

¹⁸ Australian Oilseeds Federation (2013), Better Soybeans manual http://www.australianoilseeds.com/soy_australia/Soybean_Production

¹⁹ Australian Oilseeds Federation (2013), Better Soybeans manual http://www.australianoilseeds.com/soy_australia/Soybean_Production

SECTION 4

Plant growth and physiology

4.1 Germination and emergence issues

At sowing, seed should be placed into moist soil to a depth of not more than 5 cm. Where moisture is deeper than this, drilling to 7.5 cm has been successful but emergence can be poor, particularly if heavy rain causes the soil to pack or crust before seedlings emerge. The use of rollers is generally not advised. Planters with press wheels which press the soil onto the sides of the seeds whilst leaving a crown of uncompacted soil for easy seedling emergence are preferred.¹

4.2 Plant growth stages

Table 1: Growth and development definitions

Vegetative Stages	Reproductive Stages
VE (emergence)	R1 (beginning bloom, first flower)
VC (cotyledon stage)	R2 (full bloom, flower in top 2 nodes)
V1 (first trifoliolate)	R3 (beginning pod, 5 mm pod in top 4 nodes)
V2 (second trifoliolate)	R4 (full pod, 20 mm pod in top 4 nodes)
V3 (third trifoliolate)	R5 (3 mm seed in top 4 nodes)
V(n) (nth trifoliolate)	R6 (full size seed in top 4 nodes)
V6 (flowering will soon start)	R7 (beginning maturity, one mature pod)
	R8 (full maturity, 95% of pods on the plant are mature)

4.2.1 Emergence (VE)

Soybean seed begins germination when water equal to about 50% of the seed's weight is absorbed. The radical, or primary root, is first to emerge from the seed. Shortly afterward, the hypocotyl (stem) emerges and begins growing toward the soil surface pulling the cotyledons (seed leaves) with it. This hook-shaped hypocotyl straightens once emerged and as the cotyledons unfold. Emergence (VE) normally takes five to 10 days depending on temperature, moisture conditions, variety, planting depth and soil type. As the hypocotyl arch is exposed to light and straightens, it helps to pull the cotyledons out of the ground. Epicotyl growth begins with expansion and unfolding of unifoliolate leaves.

During this time, lateral roots begin to grow from the primary root. Root hairs can be visible within five days of planting and provide the key nutrient and water absorbing functions of the plant in this early stage. The taproot will also continue growing and branching so that lateral roots can reach the centre of an 80 cm row within five to six weeks. Depending on soil type, in ideal conditions the soybean root may reach a depth of 1 to 2 metres, however the primary root mass is typically in the upper 15 to 30 cm.

Soybeans should generally be planted 25 to 40 mm deep but never deeper than 50 mm. Because the soybean must often push through crusted soil, deeper planting can

¹ NSW DPI (2007) SOYBEAN: North Coast NSW Planting Guide http://www.australianoilseeds.com/_data/assets/pdf_file/0020/7670/Soybean_North_Coast_NSW_Planting_Guide.pdf

limit plant emergence and final establishment. Maintaining soil cover levels (trash) may reduce the incidence of surface crusting thereby improving crop emergence.

Soybeans are very salt sensitive, hence fertiliser placement is important. Do not place fertiliser close to the seed or directly in the furrow as salt injury from the fertiliser may result. If fertiliser is required it should be banded 5 cm below and to the side of the planting drill. Fertiliser in the planting drill will adversely affect rhizobia survival and impact on nodulation. Soybean seed should always be inoculated with Group H inoculant to facilitate the nodulation process and allow the plant to fix its own nitrogen.²

4.2.2 Cotyledon stage (VC)

The VC stage commences when the unifoliolate leaves are fully expanded. During the VC stage, the cotyledons supply the nutrient needs of the young plant (for about 7 to 10 days). The cotyledons will lose about 70% of their dry weight from this nutrient reallocation. If one cotyledon is lost during this time, there is little effect on the growth rate of the plant. However, loss of both cotyledons at or soon after VE can reduce yields by 8-9%. Later, after the V1 stage, photosynthesis in the developing leaves allows the plant to sustain itself. New vegetative stages will now begin appearing approximately three to five days apart until the V5 stage and then two to three days apart from V5 to shortly after R5 when node number usually reaches a maximum.³

4.2.3 First trifoliolate (V1)

This stage is achieved when the first trifoliolate leaf is fully emerged and opened. The vegetative stages following VC are defined and numbered by the number of fully-developed leaf nodes on the main stem (the stage is numbered by the fully-developed trifoliolate leaves). Trifoliolate leaves on branches are not counted when determining the vegetative stages, only the trifoliolate leaves off the main stem are used in the count.⁴

4.2.4 Second node (V2)

Plants are 15 to 20 cm tall and have three nodes with two unfolded leaflets. Active nitrogen fixation from the root nodules is just beginning to occur. Most of these root nodules are within 25 cm of the soil surface with each nodule holding millions of bacteria. Nodules that are pink or red inside are active in nitrogen fixation. White, grey or green nodules are not efficiently fixing nitrogen. The top 15 cm of soil will now have soybean lateral roots rapidly developing. Any cultivation for weed control should be no deeper than absolutely necessary to minimise root pruning.⁵

4.2.5 Third to fifth nodes (V3-V5)

Soybean plants at V3 are 18 to 25 cm tall with four nodes and three unfolded leaflets. Depending upon the growth habit of the variety, the number of branches seen on the plant may increase at this point, particularly if growing in a wider row spacing and in crops with lower plant population. Up to six branches are normally developed under field conditions in branched (rather than upright) varieties with the largest branch being the main stem. V5 stage is approximately one week from R1/first flower.

Plants at V5 stage are 25-30 cm tall with six nodes of unfolded leaflets. At V5, the plant normally has axillary buds in the top stem that will develop into flower clusters (racemes). At V5, the total number of nodes that the plant can produce is established. With indeterminate soybeans, this total is higher than the number of nodes that will fully develop, however, the extra axillary buds on indeterminate varieties can allow the plant to recuperate from hail or wind that may damage some of the buds.

² Australian Oilseeds Federation (2013), Better Soybeans manual http://www.australianoilseeds.com/soy_australia/Soybean_Production

³ Australian Oilseeds Federation (2013), Better Soybeans manual http://www.australianoilseeds.com/soy_australia/Soybean_Production

⁴ Australian Oilseeds Federation (2013), Better Soybeans manual http://www.australianoilseeds.com/soy_australia/Soybean_Production

⁵ Australian Oilseeds Federation (2013), Better Soybeans manual http://www.australianoilseeds.com/soy_australia/Soybean_Production

Although the stem apex (main growing point) is dominant, damage to this growing point will stimulate axillary buds lower on the plant to branch and grow profusely. Thus, soybeans are capable of producing new branches and leaves at this stage even after hail destroys almost all the above ground foliage as long as at least one axillary bud remains intact. However, if the plant is broken off below the cotyledonary node, the plant cannot recover as no axillary buds are located below this node.⁶

4.2.6 Sixth node (V6)

Soybeans are around 30-35 cm tall at this stage with seven nodes of unfolded leaflets. By this stage the cotyledons and unifoliate leaves may have senesced and dropped from the plant. New stages are quickly unfolding every two to three days. Lateral roots have crossed over the row underground in any rows 80 cm or less. The plant is still capable of recovering from leaf damage at this stage. In general, soybean plants can tolerate up to 35% leaf loss prior to flowering without appreciable losses to grain yield, however, this decreases to just 15% once flowering commences.⁷

4.2.7 Beginning bloom (R1)

At least one flower is located at any node on the main stem. Plants should be around to 35-45 cm tall. Soybean flowering always initiates on the third to sixth node on the main stem depending on the vegetative stage at which flowering begins. Soybean commences flowering in response to lengthening hours of darkness and different varieties respond at different times. The time taken to commence flowering (i.e. the amount of time spent in the vegetative phase of growth) then influences the time for the crop to reach maturity, mature plant height and grain yield. Selection of an appropriate variety and suitable sowing time for your location is critical to achieve a high yielding crop.

Flower initiation progresses up and down the plant, with branches also flowering eventually. Within each raceme, the flowering will occur from the base to the tip, so basal pods are always more mature. Once again dominance of the primary racemes is seen over secondary racemes on the plant; however, secondary racemes can develop adjacent to primary racemes on the same axil. At this growth stage vertical roots are rapidly growing and will continue until R4-R5, as are secondary roots and root hairs nearer the soil surface.⁸

4.2.8 Full bloom (R2)

Soybean plants are around 45-50 cm tall at the beginning of full bloom. An open flower is seen at one of the two top nodes of the main stem. At least one of these two upper nodes shows a fully developed leaf. At this stage, the soybean has accumulated about 25% of its total dry weight and nutrients and has obtained about 50% of its mature height. About 50% of the total mature node number has been established. Very rapid accumulation of N, P, K and dry matter is now occurring and will continue through V6. Roots may reach across 100 cm wide rows. The appearance of new flowers on the plant begins to slow between R2.5-R3 and will be complete by R5. Major lateral roots have turned downward in the soil and nitrogen fixation by root nodules is increasing rapidly.⁹

4.2.9 Beginning pod (R3)

Plants can be up to 60-80 cm tall at this stage and have a pod on the upper four nodes of 5mm long. Temperature or moisture stress at this time can affect yield through

⁶ Australian Oilseeds Federation (2013), Better Soybeans manual http://www.australianoilseeds.com/soy_australia/Soybean_Production

⁷ Australian Oilseeds Federation (2013), Better Soybeans manual http://www.australianoilseeds.com/soy_australia/Soybean_Production

⁸ Australian Oilseeds Federation (2013), Better Soybeans manual http://www.australianoilseeds.com/soy_australia/Soybean_Production

⁹ Australian Oilseeds Federation (2013), Better Soybeans manual http://www.australianoilseeds.com/soy_australia/Soybean_Production

total pod number, bean number per pod or seed size. Partial compensation with only temporary stress can occur in soybeans, but as the plant matures from R1 to R5.5 the ability to compensate decreases. Very favourable conditions will result in greater pod number per plant at this time. Since 60-75% of most flowers typically abort on soybean, any stress that increases this abortion will greatly influence yield. Half of most flowers are lost before pods begin developing and the other half are due to pod abortion. However, the long flowering period of soybeans is one reason that soybean can compensate for lost flowers.¹⁰

4.2.10 Full pod (R4)

Rapid pod growth and the beginning of seed development mark the beginning of the full pod stage known as R4. Dry weight of pods is greatly increased from R4-R5. At this stage of growth a pod that is at least 12 mm long is present on at least one of the four upper nodes of the main stem. This stage is the most crucial period for grain yield. Any stress to the crop from R4-R6 causes more yield reduction than at any other time. Late pod formation at R4.5 to early seed fill at R5.5 is most critical. Yield reduction at this time is mainly due to fewer pods being set. This is a critical period to consider irrigation, which must be applied if required to reduce yield losses. The last flowering will occur at the main stem tip (through R5).¹¹

4.2.11 Beginning seed (R5)

Seed filling during this growth stage places significant demands for water and nutrients on the plant. Redistribution of nutrients in the plant occurs with the soybean providing about 50% of the necessary N, P and K from the plant's vegetative parts and about 50% from N fixation and nutrient uptake by the roots. Leaf loss of 100% at this stage will reduce yields by 80%; the plant is less able to compensate from stress and vegetative damage. Stresses at this stage of growth can lower grain yields by reducing pod number and the number of beans per pod, or by reducing seed size.

This stage has seed at least 3 mm long in one of the pods on one of the four upper nodes of the main stem. During R5, the plant attains its maximum height, node number and leaf area. Nitrogen fixation peaks and begins to drop. Seeds continue a steady period of dry weight accumulation. As R5 concludes, nutrient accumulation peaks in the leaves and then begins the process of redistributing to the seed. Seed accumulation will continue until shortly after R6.5, with about 80% of total seed dry weight being accomplished.¹²

4.2.12 Full seed (R6)

R6 is also known as the "green bean" stage or beginning full seed stage. Total pod weight peaks during this stage. Growth rate of the beans is rapid during this stage and peaks at R7. At the beginning of this stage a pod containing a green seed that fills the pod cavity is present on at least one of the four top nodes of the main stem. Rapid leaf yellowing commences following R6 until R8, when all leaves have fallen. Within R6, three to six trifoliolate leaves may fall from the lowest nodes on the plant prior to leaf yellowing. Root growth is complete at around R6.5.¹³

4.2.13 Beginning maturity (R7)

R7 commences with one normal pod on the main stem obtaining mature colour (e.g. brown or tan). Dry matter begins to peak in individual seeds. This occurs when all green colouring is lost from both the seeds and the pods (they appear pale yellow). Seeds

¹⁰ Australian Oilseeds Federation (2013), Better Soybeans manual http://www.australianoilseeds.com/soy_australia/Soybean_Production

¹¹ Australian Oilseeds Federation (2013), Better Soybeans manual http://www.australianoilseeds.com/soy_australia/Soybean_Production

¹² Australian Oilseeds Federation (2013), Better Soybeans manual http://www.australianoilseeds.com/soy_australia/Soybean_Production

¹³ Australian Oilseeds Federation (2013), Better Soybeans manual http://www.australianoilseeds.com/soy_australia/Soybean_Production

contain about 60% moisture at physiological maturity. Stress at this stage or later has little effect on yield unless the pods are physically damaged, dropped to the ground or seeds are shattered from the pods.¹⁴

4.2.14 Full maturity (R8)

R8 represents full maturity of the soybean plant with 95% of the pods at their mature colour. Five to 10 days of good drying weather after this stage is required for the grain to reach less than 15% moisture. Mature soybean grain will lose moisture rapidly with warm and dry weather.

Harvest usually occurs at weeks 18–20. At this time, 95% of the pods are brown/tan, and the grain moisture is within the range of 15 to 18% in coastal environments and 13 to 15% in inland environments. Grain receival standards and storage require grain moisture level of 12 to 13%. Harvest soybeans as soon as possible to maximise grain quality by reducing the risk of damage from wet weather or harvest losses from over-dry grain.¹⁵

Soybeans commence flowering in response to lengthening hours of darkness, which has an effect on the time to maturity, mature plant height and yield. Soybean plant growth must achieve full canopy cover by the start of flowering or by mid flowering.

¹⁴ Australian Oilseeds Federation (2013), Better Soybeans manual http://www.australianoilseeds.com/soy_australia/Soybean_Production

¹⁵ Australian Oilseeds Federation (2013), Better Soybeans manual http://www.australianoilseeds.com/soy_australia/Soybean_Production

SECTION 5

Nutrition and fertiliser

5.1 Crop removal rates

Soybeans have a large requirement for phosphorous (P). For every tonne of grain produced the crop will take up 11 kg P/ha and the grain will remove 7 kg P/ha. Soybeans have an extended period of P uptake right up until mid pod-fill. High fertility paddocks may be better at providing extended P availability, rather than extra large doses of starter P fertiliser.¹

Soybeans are a crop that removes a lot of potassium (K) in harvested grains (on average, 20 kg K/t). Therefore, in high yielding irrigated crops removal rates can be high and the resultant K-fertiliser rate to maintain soil K-status can be significant.²

5.2 Soil testing

Soybeans have a high demand for plant nutrients, in particular nitrogen, phosphorus and potassium. When deciding how much fertiliser to apply to a soybean crop it is important to know the nutrient status of the soil and the critical level of soil nutrients, particularly phosphorus and potassium, that are needed to give the maximum economic yield. A soil test is the best way to determine soil nutrient status.³

Table 1: The approximate quantities of major nutrients utilised by a soybean grain crop

Plant part	Yield 2.5t/ha			
	Plant nutrient (kg/ha)			
	N	P	K	S
Total plant uptake	220-270	15-20	100-120	15-20
Nutrients removed in seed	150-170	12-15	40-50	9-12

NOTE: This table should not be used as a direct indicator of crop fertiliser requirements, but it is a useful guide to soil maintenance requirements – an important consideration for low fertility soils.

5.3 Nitrogen (N)

Soybeans have a large requirement for nitrogen, but can obtain the majority of this from the air via *Rhizobium* bacteria forming nodules on their root system. Soybean seed needs to be inoculated with Group H *rhizobia* to get effective nodulation and ensure adequate nitrogen nutrition to the plant. *Rhizobium* bacteria need low nitrogen soils for optimum effectiveness and soybeans grown after cereal crops rather than pasture provide these conditions.⁴

More information

[GRDC 2015 Fixing more nitrogen in pulse crops](#)

¹ Agriculture Victoria (2006) Growing Soybean <http://agriculture.vic.gov.au/agriculture/grains-and-other-crops/crop-production/growing-soybean>

² QDAF (2010) Growing soybeans <https://www.daf.qld.gov.au/plants/field-crops-and-pastures/broadacre-field-crops/soybeans/growing-guide>

³ Australian Oilseeds Federation (2013), Better Soybeans manual http://www.australianoilseeds.com/soy-australia/Soybean_Production

⁴ Agriculture Victoria (2006) Growing soybean <http://agriculture.vic.gov.au/agriculture/grains-and-other-crops/crop-production/growing-soybean>

Once established the nitrogen fixing bacteria (rhizobia) in the root nodules can supply soybean plants with all their nitrogen requirements, provided soil mineral N is low. Soybean N fixation tends to decrease as soil mineral N increases, as the plant prefers to accumulate 'easy' soil nitrate rather than support rhizobium to fix atmospheric N₂. High mineral N in the early stages of crop establishment can delay early nodule development (possibly causing an N deficiency when the soil N runs out and the plant has to then allow nodules to develop), while mineral N late in the season (e.g. from a decomposing cane trash blanket) can prematurely shut down N fixation but also contribute to high yields and grain protein.

A small amount (up to about 15 kg of N per hectare) of 'starter' nitrogen may be beneficial when the crop is sown into high crop residue loads with high C:N ratios (e.g. wheat straw or sugarcane trash), as the establishing soybeans need some soil N to grow while nodules are developing. Another situation where some starter N may benefit is in late sown crops, as it helps to ensure good early growth of seedlings and adequate height to the lowest pod. Care must be taken not to apply too much starter N as this will raise soil mineral N concentrations and have a detrimental effect on the growth of nodules that supply nitrogen to the plant later in its growth cycle.⁵

5.4 Phosphorus (P)

Soils predominantly derived from sedimentary and granitic rocks are extremely low in phosphorus and high rates of phosphatic fertiliser are required for economic yields. The heavy clay flood plain soils of the NSW Richmond Valley have high levels of reactive iron (that fixes phosphorus), and this will be reflected in high Phosphorus Buffer Indices (PBI) in soil tests. In these types of soils, a large proportion of the phosphorus applied in fertiliser can be fixed (strongly sorbed) in a form that is unavailable to the current crop. The same applies in the red volcanic soils of the inland and coastal Burnett regions of Queensland, where iron and aluminium oxides sorb (fix) the P. Soybeans grown on podsollic soils will probably require P fertilizer to maximise yields depending on their P status and P fixing ability.

Because of the variability in soil P status and P fixing ability of the soils in which soybeans are grown, it is essential that soil P tests are undertaken. Two soil P analyses are required - Colwell-P to determine the soil P status and PBI to determine the P fixing ability of the soil (Table 2).

Phosphorus drilled with or banded close to the seed is the most effective way to supply this nutrient to the soybean plant. Soybeans are very efficient at developing roots in and around a P fertilizer band. For practical and economic reasons, most growers with soils of moderate P status (as indicated by Colwell-P) and a low P sorbing ability (indicated by PBI) broadcast and incorporate the entire fertiliser requirement prior to sowing. However this will not be appropriate in soils with a strong P sorbing capacity (i.e. high PBI), and P fertilizer will need to be banded to maximize crop recovery.

⁵ Australian Oilseeds Federation (2013), Better Soybeans manual http://www.australianoilseeds.com/soy_australia/Soybean_Production

Table 2: Indicative phosphorus application rates (kg P/ha) and preferred application method in soils with contrasting soil phosphorus status (measured using the Colwell method) and Phosphorus Buffer Indices (PBI). Phosphorus fertilizer should always be incorporated into soil, rather than be left on the soil surface.

Colwell P (mg/kg)	Rate of P fertilizer (kg P/ha)		
	PBI <100	PBI 100-200	PBI >200
<10	40P broadcast	30P banded or 40P broadcast	30P banded
10-20	30P broadcast	25P banded or 30P broadcast	30P banded
20-30	20P broadcast	20P banded or broadcast	20P banded
30-40	10P broadcast	10P banded or broadcast	10P banded
>40	0	0	0

Some P fertilizer can be placed in the seeding row with the seed at planting, but there are limits to how much can be applied in this fashion. Both the germinating seedling and the rhizobium inoculant can both be damaged if rates are too high. The maximum safe rate with seed will depend on the amount of soil mixing occurring at planting, the distance between the seed and the fertilizer and the type of fertilizer product used. When direct drilling with minimal soil disturbance (e.g. disc seeders), safe rates will be lower than with tine planters that cause more soil disturbance. Your local advisor or fertilizer reseller can help you with the maximum safe rates of the fertilizer product you intend to use. The amount of P that can be applied with or near the seed will be reduced if the fertilizer product contains N. If you cannot apply sufficiently high rates in the planting furrow, pre-plant band applications or additional tines that place fertilizer below and beside the seed can be effective.⁶

5.5 Sulphur (S)

Soybeans are a high protein legume and insufficient sulphur limits yield. Typically, soybean grain contains N:S ratios of about 20:1, so grain containing 40-41% protein (6.4-6.5% N) will contain about 0.3-0.35% S. Generally, single superphosphate applications supply adequate sulphur, but this is often not used as a phosphorus fertilizer. Gypsum is a cheap alternative to improve soil S status while potassium sulphate is a source of potash (K) and S. On high phosphorus testing soil, inadequate sulphur can frequently limit yields, especially with direct drilled crops. The KCl-40 soil test is a good guide for sulphur fertiliser requirements – it is suggested if KCl-40 S test levels are below 8-10 mg/kg, apply fertiliser containing sulphur at rates that will supply up to 15 kg S/ha.⁷

5.6 Potassium (K)

Soybeans require large amounts of potassium (K) to achieve good yields and so soil K-status is important. Soils that have low exchangeable K-levels prior to planting (i.e. <0.3 meq/100g) are likely to respond to K-fertiliser application. In coastal areas with sugarcane-dominant cropping systems, K is usually one of the main nutrients required for good soybean growth during a fallow.

Soybeans are capable of accumulating large amounts of K in the plant material (100-150 kg K/ha), and if the soil K-status is good, this accumulation may be well in excess of the minimal requirements for growth and yield.⁸

⁶ Australian Oilseeds Federation (2013), Better Soybeans manual http://www.australianoilseeds.com/soy-australia/Soybean_Production

⁷ Australian Oilseeds Federation (2013), Better Soybeans manual http://www.australianoilseeds.com/soy-australia/Soybean_Production

⁸ QDAF (2010) Growing soybeans <https://www.daf.qld.gov.au/plants/field-crops-and-pastures/broadacre-field-crops/soybeans/growing-guide>

Soybean yields may be limited by potassium deficiencies on sandy soils and those soils with a long history of intensive cropping where heavy export of K in hay, silage, grain or sugarcane has occurred. Table 3 gives a guide to potassium fertiliser requirements for soybean crops, although the critical soil test value for exchangeable K is affected by things like the soil cation exchange capacity and the relative availability of sodium (Na) to potassium in some heavy clay soils. The apparent effect of high exchangeable Na on K availability is probably caused by poor soil structure restricting the soil volume from which roots can extract K as well as their ability to take up K. The result is that higher soil K concentrations are needed for optimum yield.

Table 3: Potassium fertiliser recommendations (kg K/ha) for soybean crops grown in soils with differing exchangeable potassium and cation exchange capacity (CEC)

Soils with CEC < 20 cmol/kg		Soils with CEC > 30 cmol/kg	
Exchangeable potassium (c mol/kg)	K recommendation (kg K/ha)	Exchangeable potassium (c mol/kg)	K recommendation (kg K/ha)
0 – 0.1	25–40	0 – 0.2	50–75
0.1–0.2	15–25	0.2 – 0.4	25–50
0.2–0.4	5–15	0.4 – 0.6	10–25
Over 0.4	Nil	Over 0.6	Nil

Muriate of potash (MOP, containing 50% K) and potassium sulphate (SOP, containing 41% K and 18% S) are the most common forms of K fertilizer.

Soils can also contain some slow release forms of K that are not measured in the commercial soil test for exchangeable K, and there is an active soils research program investigating new soil tests to fill this gap. The greatest amounts of these reserves (which are present as slowly dissolvable soil minerals) tend to be in 'young' alluvial soils in creek flats or at the lower end of river valleys, while these reserves are not present in granitic soils, soils produced from in situ weathering of basalt (i.e. eastern Darling Downs) or on red volcanic soils. In these situations, and perhaps more generally, it is safer to assume that exchangeable K is all there is, and fertilize accordingly.

When sowing, never place any muriate of potash (MOP) fertiliser in contact with the seed, as plant establishment will be impaired by the salt effect (rapid dissolution of the fertilizer, resulting in a high concentration of dissolved ions around the fertilizer band) of the fertiliser. There is a little more flexibility in application if using potassium sulphate (SOP), which does not produce as strong a salt effect. However, SOP application rates need to be 20% higher to apply the same amount of K, and are generally much more expensive than MOP. There is no need to band K fertilizers, or to put them in close proximity to the seeding trench, so application and incorporation during land preparation or banding away from the immediate seeding area in minimum tillage systems are preferred.

Rates of K removal in soybean grain are as high or higher than any other grain or grain legume crop, with ~ 20 kg K/t of grain removed at harvest. This compares to 3-4 kg K/t in grains and 8-10 kg K/t in other grain legumes like mungbeans and chickpeas. Removal rates in high yielding soybean crops are comparable to that in irrigated cotton at 60-80 kg K/ha.⁹

5.7 Micronutrients

5.7.1 Zinc (Zn)

Zinc deficiency is widespread on the alkaline grey clays of inland irrigation areas and can also be low on some of the sandier soils in the coastal sugarcane areas. These differences may be due to low soil Zn (acidic, sandy soils) or to low availability of Zn to plants (alkaline clays), and each soil type responds differently to soil applications.

⁹ Australian Oilseeds Federation (2013), Better Soybeans manual http://www.australianoilseeds.com/soy_australia/Soybean_Production

Although it is a well-known problem with soybeans, zinc deficiency is still occasionally found. Some varieties may be more sensitive than others. Soil tests provide an indication of plant available Zn status, but are not very precise and more work is needed to define a soil test critical value. At this stage, critical values lie somewhere between 0.4 (acidic soils) and 0.8 (alkaline soils) mg DTPA-extractable Zn/kg soil, with the higher critical value in the alkaline soils reflecting the reduced plant availability at higher soil pH.

Zinc can be applied either to the soil or to the foliage, although the effectiveness and residual value of the soil strategies will vary depending on whether you are fixing a low soil Zn situation in acidic sand or trying to make some Zn available to plants in alkaline clay. In lighter textured, neutral to acidic soils applications to soil are very effective and have a good residual value (e.g. an application of 30 kg/ha of zinc oxide to the soil every 5–7 years will fix any problems). However in heavier, alkaline clays it is more effective to apply small amounts with your starter P fertilizer in the seeding trench to ensure early plant access. Large applications mixed through the soil may be rendered unavailable to plants, limiting residual values. Foliar applications of zinc sulphate heptahydrate at 4 kg/ha 6–8 weeks after planting are always effective, but in soils with very low Zn, deficiencies may be evident well before the plants get enough leaf area to absorb this foliar application. In these low Zn soils, some Zn in the starter fertilizer in the seeding row will help.¹⁰

5.7.2 Molybdenum (Mo)

Root nodule bacteria require molybdenum as part of an enzyme to convert atmospheric nitrogen to a form that is used by the plant. Most soils on the NSW North Coast and Northern Tablelands are acidic and deficient in plant available molybdenum, and levels can also be marginal in many of the acidic, sandier coastal sugarcane soils in Qld. Soil tests for Mo are not reliable, and so low rate applications of products like sodium molybdate (dissolved and sprayed onto the soil before planting, or as a foliar spray early in the season) can be an effective insurance policy to ensure good N fixation. Mo can also be applied as a seed dressing of molybdenum trioxide (although check for effects on efficacy of inoculants if considering this method), or as a blend with things like superphosphate fertilizers, which are used to enhance N fixation of legumes in pastures. Application rates of 50–100 g Mo/ha are only required every 2–3 years.¹¹

5.7.3 Other trace elements

Except for molybdenum on the NSW North Coast and Tablelands, and zinc on the grey clays of inland irrigation areas, fertiliser trace elements are generally not required for soybean crops. The exceptions may be on the sands and Wallum soils found in coastal areas, where copper, zinc and manganese deficiencies may occur. In these situations, the lack of reliable soil test diagnostics means that foliar applications of a mix of trace elements can sometimes provide useful insurance.¹²

5.8 Nutritional deficiencies

5.8.1 Boron (B) deficiency

Description: Plants grow poorly, lack vigour and are stunted, with stout stems. Symptoms develop first on younger leaves, turning pale green and yellow tissue. Later, dark brown necrotic spots develop in the yellow tissue. The tips and edges of young expanding leaves often curl down and under. Older leaves remain dark green. The buds at the top of the plant and at the nodes may die and the young underdeveloped leaves

¹⁰ Australian Oilseeds Federation (2013), Better Soybeans manual http://www.australianoilseeds.com/soy_australia/Soybean_Production

¹¹ Australian Oilseeds Federation (2013), Better Soybeans manual http://www.australianoilseeds.com/soy_australia/Soybean_Production

¹² Australian Oilseeds Federation (2013), Better Soybeans manual http://www.australianoilseeds.com/soy_australia/Soybean_Production

or flowers turn pale brown. Pollination and seed set are reduced, and in severe cases plants may die.

Conditions: Boron deficiency can occur in sandy soils leached of boron, alkaline soils containing free lime, soils low in organic matter, acid peat soils and in soils of acid igneous or fresh-water sediment parent material.

Management: Soil test for available boron. Boron may be applied to the soil as borax, boric acid and chelated boron compounds. Boric acid or chelated B compounds may be applied as a foliar spray 5 to 6 weeks after seedling emergence or as soon as symptoms appear. Over fertilization with B can result in toxicity, so be careful with applications to soil. Applying products in solution sprayed onto soil is an effective strategy of getting uniform distribution of relatively low rates of product.¹³

5.8.2 Calcium (Ca) deficiency

Description: Calcium deficiency causes stunting of plants, with short internodes, stout stems and dark green leaves. Symptoms first appear on young leaves. The leaves fail to expand the tips, margins cup up or down, leaves may turn yellow developing necrotic pale brown areas. The entire forming bud will often die if the deficiency is severe. On older plants the veins of the upper leaves die and turn brown, and the areas beside these veins turn yellow. Pod set is reduced resulting in low yields.

Conditions: Ca is important for normal plant growth and development. It is also involved in nitrogen fixation. Ca deficiency may occur in acidic sandy soils leached of Ca, strongly acid peat soils of low Ca, alkaline or sodic soils where sodium and pH are high, or soils with high aluminium levels and low exchangeable Ca levels. It is unusual to encounter Ca deficiency in most cropping soils.

Management: Apply lime or dolomite if the soil pH is low, or gypsum if only Ca is lacking. Over liming can cause deficiency in other nutrients such as potassium, magnesium, iron, zinc and copper.¹⁴

5.8.3 Iron (Fe) deficiency

Description: Affected crops are unthrifty, lack vigour, stunted with thin, spindly stems, yellow young leaves and dark green older leaves. Symptoms develop first on young expanding leaves, with pale yellowing in the interveinal area. The veins remain green for a while but later turn yellow. On severely affected plants dark brown lesions develop on the veins and pale brown lesions develop on the leaf margins and on petioles. The underside of the leaflet develops more prominent symptoms. These lesions occur after the whole leaf has turned yellow, distinguishing Fe deficiency from sulphur deficiency (see below). Older leaves remain green.

Conditions: Iron deficiency occurs on alkaline soils with low soluble Fe levels, waterlogged soils, acid soils with excess levels of soluble manganese, zinc, copper or nickel, in sandy soils low in total Fe and in peat soils.

Management: Inorganic Fe salts can effectively control deficiencies, but will quickly become insoluble and unavailable to plants if placed into soil. Foliar sprays of inorganic salts or chelates need to be applied every 10 to 15 days to provide Fe to the new leaves. Apply Fe salts or organic chelates to the soil to keep Fe in solution. Apply the chelate most appropriate for the soil type.¹⁵

5.8.4 Magnesium (Mg) deficiency

Description: Affected crops are pale green, shorter than usual with thin spindly stems and pale green-yellow leaves. Symptoms start on the middle leaves as pale yellow

¹³ Australian Oilseeds Federation (2013), Better Soybeans manual http://www.australianoilseeds.com/soy-australia/Soybean_Production

¹⁴ Australian Oilseeds Federation (2013), Better Soybeans manual http://www.australianoilseeds.com/soy-australia/Soybean_Production

¹⁵ Australian Oilseeds Federation (2013), Better Soybeans manual http://www.australianoilseeds.com/soy-australia/Soybean_Production

interveinal mottling, spreading to older leaflets and advancing up the plant to younger leaves. If deficiency is severe, light brown lesions develop in the interveinal areas spreading towards the margins, veins remain green and the interveinal area may become puckered.

Conditions: Mg deficiency inhibits nitrogen fixation. Deficiency is likely to occur in acidic sandy soils leached of Mg, strongly acidic peat soils and soil over-fertilised with Ca or K.

Management: Dolomite can be broadcast and mixed into soils several months before planting. Apply magnesium sulphate or magnesium chloride in a band at or before planting. Apply soluble salts in irrigation water. Foliar sprays are not recommended.¹⁶

5.8.5 Manganese (Mn) deficiency/toxicity

Deficiency: Symptoms are similar to the early stages of Fe deficiency (see above). Affected plants tend to be in patches, and are stunted with short, thin stems and pale green-yellow foliage. Young leaves turn pale green with a yellow mottle developing between the veins. The veins remain green. Later, small dark brown dead spots form in the yellow areas of leaves. If the deficiency becomes severe the youngest leaves may fall off. Older leaves remain green.

Toxicity: Mn toxicity develops first on older leaves. Plants are stunted with short stout stems and dark green leaves. Pinpricked red-brown dead lesions develop on the upper surface between the veins. With severe toxicity red-brown areas develop on the veins, being prominent on the underside of the leaves. The younger leaves are smaller than usual and develop yellow mottling changing to red-brown necrotic lesions.

Conditions: Mn deficiency may occur in strongly alkaline soils, poorly drained soils with high organic matter, strongly acid soils leached of Mn and in soils formed from rocks low in Mn.

Mn toxicity can develop on strongly acid soils or in waterlogged soils where the lack of oxygen has increased the availability of the soil Mn.

Management: Deficiency can be controlled by foliar sprays or soil dressings of Mn salts, such as manganese sulphate. Foliar sprays should be applied 3-5 weeks after emergence and again if symptoms occur.

Toxicity can be controlled by applying lime to acid soils to raise pH and thus reduce Mn availability to plants. Improve drainage and avoid over fertilising with Mn fertilisers. Applying irrigation water low in Mn or mulching with organic materials can also remove soluble Mn from the soil and decrease Mn toxicity.¹⁷

5.8.6 Nitrogen (N) and Molybdenum (Mo) deficiency

Description: N deficiency makes older leaves turn pale or yellowish-green, and in severe cases the whole plant can appear a pale yellow green colour. If N deficiency occurs during seed filling, the 'self-destruct' process seen during maturation (i.e. leaf browning and shedding) is accelerated and seed fill can be affected.

Conditions: Deficiency can occur during early growth, before the nodules are well developed and capable of fixing N. This is often the situation when soil mineral N reserves are low – perhaps as a result of microbial immobilization of available N during decomposition of heavy crop residues like cane trash. In later crop stages deficiency develops commonly because of poor nodulation, which can be the result of ineffective inoculation practices (i.e. low numbers of rhizobia added or surviving long enough to infect roots), extreme soil acidity (leading to toxic levels of aluminium or manganese) or wet or cool soil temperatures. Typically, if soybean has been grown in the field in the

¹⁶ Australian Oilseeds Federation (2013), Better Soybeans manual http://www.australianoilseeds.com/soy_australia/Soybean_Production

¹⁷ Australian Oilseeds Federation (2013), Better Soybeans manual http://www.australianoilseeds.com/soy_australia/Soybean_Production

recent past, there should not be a problem related to insufficient bacteria present in the soil to properly inoculate the roots.

Management: If you suspect there has been an N deficiency or nodulation problem in the past, it would be important for the future to plant inoculated seeds. Most often, inoculation problems are related to poor growth conditions. Soybeans do not grow very well in periodically wet or very acidic soils; ensuring adequate soil pH and good drainage are probably the best ways to reduce the problem of poor nodulation.



Figure 1: Normal soybean canopies in the foreground, compared to P deficient, stunted canopies with yellow spotting on leaves in the background. (Photo: Australian Oilseeds Federation)

The problem of heavy residue loads and soil N unavailability can be addressed by applying a low rate of starter N fertilizer to aid early stages of crop growth (until nodules are functional). If nodulation is poor and N deficiency becomes obvious later in crop growth (e.g. after a water logging event) topdressing with N fertilizer may provide some benefits – especially if not too late in crop development (i.e. during seed filling).¹⁸

5.8.7 Phosphorus (P) deficiency

Description: Phosphorus deficiency may cause stunted growth, dark green coloration of the leaves and leaf cupping. Symptoms occur first on older leaves. Severe deficiency can result in fine yellow spotting on older leaves, with these yellow spots subsequently coalescing into necrotic patches. Older leaves and petioles will sag and be shed prematurely.

Phosphorus deficiency can delay flowering, although not as much as in some cereal crops, but conversely can accelerate senescence and maturation during pod filling. This results in small seed size and reduced yields. The combination of stunted plants and premature senescence can result in greater difficulty recovering grain at harvest.



Figure 2: Prematurely senesced P deficient soybean canopies in mid pod filling on the left of this image, compared to canopies with adequate P on the right. (Photo: Australian Oilseeds Federation)

Conditions: Phosphorus deficiency often occurs in early stages of growth, when root systems are small and only able to access small soil volumes. The deficiency can be accentuated when soils are cool and wet, due to slower root system development and decreased phosphorus uptake. Long bare fallows can also reduce populations of

¹⁸ Australian Oilseeds Federation (2013), Better Soybeans manual http://www.australianoilseeds.com/soy_australia/Soybean_Production

mycorrhizal fungi that assist plants in uptake of phosphorus, increasing the reliance on P fertilizers.

Management: Phosphorus deficiency is best prevented by regularly soil testing to monitor soil P status and applying the appropriate rate and form of P fertilizer at or before sowing. It is difficult to address a P deficit once the soybean crop has established.¹⁹

5.8.8 Potassium (K) deficiency



Figure 3: Potassium deficiency in soybeans. Note the yellowing and marginal necrosis (scorching) on leaves lower in the canopy. (Photo: Australian Oilseeds Federation)

Description: Potassium deficiency is observed as yellowing or browning and necrosis (death) of the edge of older leaves. When the problem persists, this deficiency will continue to move up from older to newer leaves, while the top leaves may look completely green.

Conditions: Potassium deficiencies develop more often at early stages of development when the root system is small. However, symptoms may also start to appear during seed filling, when the plant is trying to re-distribute K in the vegetative plant parts to meet the demand of the developing seeds. Soil K concentrations are often highest in topsoil layers, due to accumulation of K from crop residues and fertilizer – K will only leach in light, sandy soils. As a result, K deficiency may appear in crops during a dry spell (when top soil root activity is reduced and roots are active in subsoils with lower K status), but disappear when rain falls and topsoil moisture (and root activity) are restored. While this may be visually pleasing, yield may already have been compromised.

Management: Management is similar to that for P. The best way to manage K fertility is by understanding the soil K status and applying the appropriate rate of K fertilizer to the soil prior to sowing. Fertilizer K has excellent residual value in soil so applying excess K fertilizer (e.g. if the yield is lower than expected) is still money in the soil fertility bank.²⁰

¹⁹ Australian Oilseeds Federation (2013), Better Soybeans manual http://www.australianoilseeds.com/soy_australia/Soybean_Production

²⁰ Australian Oilseeds Federation (2013), Better Soybeans manual http://www.australianoilseeds.com/soy_australia/Soybean_Production

5.8.9 Sulphur (S) deficiency

Description: Symptoms appear first on the youngest leaves. In young crops the whole plant may be pale green. Older crops are stunted with thin stems, the young leaves are pale green to yellow and the older leaves remain green.

Conditions: Deficiency occurs in soils low in organic matter, soils formed from parent material low in S or acidic sandy soils leached of S.

Management: Elemental S should be applied to soils about 4 months, while S can also be supplied more rapidly by pre-planting applications of gypsum and/or sulphur fertilisers (e.g. potassium sulphate, or sulphate of ammonia). Soluble salts can be applied in irrigation water. If phosphorous is also low, application of single superphosphate may correct both deficiencies.²¹

5.8.10 Zinc (Zn) deficiency

Description: Affected plants are stunted with thin short stems, lack vigour, mature slowly and have pale green to bronze foliage. The first symptoms are a pale mottling in the interveinal areas of the middle leaves. In later growth stages older leaves become affected while the younger leaves remain green. If the deficiency is severe the older leaves develop small bronze spots in the interveinal areas, the leaf edges cup downwards and the leaflets point towards the ground. The leaflets die and drop off.

Conditions: The deficiency is likely to occur in strongly alkaline soils, leached sandy soils and soils that have been recently levelled, exposing Zn deficient sub soils. Soils heavily fertilised with phosphates can induce Zn deficiency.

Management: Soil dressings of Zn chelates, sulphates or oxides should be mixed into deficient soils 2-3 months prior to planting. Compound Zn fertilisers can be applied in a band at planting. Deficiencies identified in-crop can be treated with foliar sprays provided the deficiency is identified within 6 weeks of emergence.²²

²¹ Australian Oilseeds Federation (2013), Better Soybeans manual http://www.australianoilseeds.com/soy_australia/Soybean_Production

²² Australian Oilseeds Federation (2013), Better Soybeans manual http://www.australianoilseeds.com/soy_australia/Soybean_Production

SECTION 6

Weed control

Weeds compete with soybeans for moisture, nutrients and light. Weed contamination of the crop can drastically reduce grain yield and increase harvest costs from mechanical complications and blockages. Further costs may be incurred if weed seeds have to be graded out of the harvested grain.

Soybeans are most sensitive to weed competition four to seven weeks after emergence. Extreme grass competition can affect soybean yields much earlier, especially if conditions are dry. Tall growing weeds (Apple of Peru, gooseberries) that push through the crop canopy can shade the crop, causing leaf fall and straggly, weak-stemmed plants with low pod counts. Under cool, humid conditions these crops are more subject to sclerotinia.

Barnyard grass (*Echinochloa* spp.), Bathurst burr (*Xanthium spinosum*), blackberry nightshade (*Solanum nigrum*) and bladder ketmia (*Hibiscus trinom*) are present in most irrigation and dryland areas and will vigorously compete with the soybean crop. Additionally, Bathurst burr and blackberry nightshade are seed quality contaminants.

Uncontrolled growth of troublesome weeds such as apple of Peru (*Nicandra physalodes*), jute (*Corchorus* spp.) and sesbania pea (*Sesbania cannabina*) can even prevent harvesting because of their tall growth habit.

Vines, typically from the Convolvulus family (bellvine *Ipomoea plebia*), are commonly major problems in coastal soybeans grown in cane farming rotations because of weed competition effects and their vigorous twining habit which may prevent harvesting of the mature soybean crop.

Adverse effects of weeds on soybean yield are determined by:

- Weed – species, growth habit, density and duration of competition;
- Crop – vigour, density and planting configuration.

Weed control starts with an Integrated Weed Management (IWM) program to manage the weed seed bank in the soil.

Since no single herbicide or management option will control all weeds, growers should be conscious of the importance of crop rotations. For example, rotation with maize allows the use of a range of herbicides to control problem broadleaf weeds of soybean crops.

Ideally, always try to control weeds before planting. Pre-plant application of knockdown sprays using glyphosate is safe, cheap and effective, and helps the soybean crop get a rapid start.¹

A well-managed, weed-free fallow is the first step essential for good weed management in any field cropping activities. With conventional cultivation a weed-free seedbed is best achieved with an early working and follow-up cultivations to help kill weeds and remove new seedlings. Full cultivation is falling out of favour in many areas as it doesn't align with soil and moisture conservation philosophies. The widespread availability, adoption and price reduction of autosteer GPS across much of the grains industry has meant that more growers are adopting reduced tillage systems. In no-till and reduced till crops, herbicide sprays are used as alternatives to cultivations.

¹ Australian Oilseeds Federation (2013), Better Soybeans manual http://www.australianoilseeds.com/soy_australia/Soybean_Production

The development of a dense canopy will assist in reducing the effect of weeds germinating later in the season. However, do not think this alone will compensate for poor (or absent) weed management. Establishing a uniform, robust plant stand at the targeted plant population is an important step in minimising gappy crops, which allow weeds to flourish. Sowing too deep, into compacted, crusted or waterlogged soil are all factors that can reduce establishment and increase weed competition. Early canopy closure is best achieved by sowing in narrower rows, however this will not suit many farming systems in rotation with other row crops like cotton, maize and sugarcane. Wide rows allow inter-row cultivation and low cost band spraying of rows.²

6.1 Pre-emergent herbicides

An important point for effective herbicide use and getting the most out of herbicides (Table 1) depends on several factors:

- It is much easier, cheaper and more effective to control weeds when they are small.
- As a general rule, ground rig application is more effective than aerial application because of better coverage.
- Read the herbicide label carefully for details on optimum application methods, optimum conditions for spraying and the appropriate Personal Protective Equipment (PPE) required to safely mix, load and apply the product(s).
- Be aware that weeds can become resistant to herbicides if they are not used as recommended. Practice good crop rotations, rotate herbicide groups and combine chemical and non-chemical weed control methods to reduce the chance of weeds developing resistance.

Under conventional cultivation with a fine seedbed, grass weeds may be economically controlled with pre-emergent herbicides like trifluralin (Triflur[®]) and pendimethalin (Stomp[®]). These products are soil incorporated and need a good seedbed free from large clods (grass seeds inside clods can germinate, establish and survive after rain 'melts' clods). Metolachlor products like Dual Gold[®] are best surface applied immediately post planting. Like trifluralin and pendimethalin, metolachlor has very limited activity on many broadleaf weeds.

Metribuzin is another pre-emergent herbicide that has primarily broadleaf activity, however there are very strict caveats regarding the use of this product – refer to the label. Some growers have also had success with flumetsulam (Broadstrike[®]) when applied as a pre-emergent herbicide for a small range of broadleaf weeds. It is commonly mixed with pendimethalin.³

6.1.1 Grasses

- A range of selective herbicides available that will control grasses within soybeans.
- Generally a large window of opportunity to control post emergent grasses however early spraying is cheapest and most effective.
- Most are Group A herbicides which are all lethal to all other grass crops (maize, sugarcane, etc). Beware of spray drift and keep a spray diary, noting wind speed and direction.
- Some are very expensive and have long withholding periods.
- Some growers have had success using paraquat/diquat mixes under shielded sprayers.
- Interrow cultivation may also be possible with Lilliston type cultivators, finger rakes, etc., however this will not suit the philosophy of zero tillage systems.⁴

² Australian Oilseeds Federation (2013), Better Soybeans manual http://www.australianoilseeds.com/soy_australia/Soybean_Production

³ Australian Oilseeds Federation (2013), Better Soybeans manual http://www.australianoilseeds.com/soy_australia/Soybean_Production

⁴ Australian Oilseeds Federation (2013), Better Soybeans manual http://www.australianoilseeds.com/soy_australia/Soybean_Production

6.1.2 Broadleaf

- Limited number of products.
- Very small window of opportunity for post-emergent broadleaf control.
- Expensive and only effective on very small weeds. Cannot be used as a salvage spray.
- Bad vine and broadleaf infestations usually spell disaster for a grain crop.
- Spinnaker has a very long plant back period for other crops – read the label.⁵



Figure 1: Bathurst burr. (Photo: DAFF Qld website)

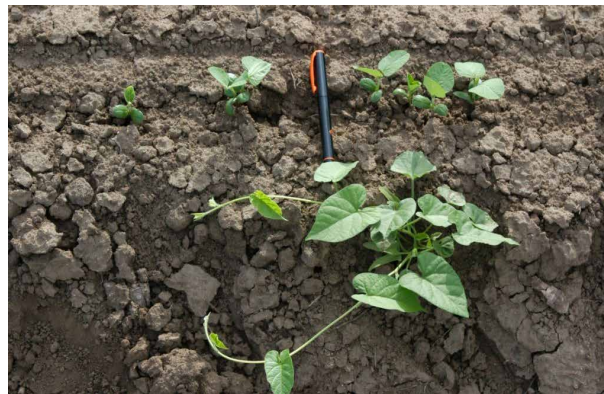

Figure 2: Convolvulus – bellvine. (Photo: DAFF Qld website)



Figure 3: Sesbania seedling showing juvenile and adult leaf forms. (Photo: DAFF Qld website)

⁵ Australian Oilseeds Federation (2013), Better Soybeans manual http://www.australianoilseeds.com/soy_australia/Soybean_Production

Table 1: Herbicides registered for weed control in soybeans

Situation	Weed	Active ingredient	Product example	Rate	Withholding period (WHP)
Pre-plant	Grasses and some broadleaf	Trifluralin ¹	Triflur [®] 480g/L	1.2-2.3 L/ha	Nil
		Pendimethalin ¹	Stomp Aqua [®]	1.8- 2.2 L/ha	Nil
		Metolachlor ²	Dual gold [®]	1.0-2.0 L/ha	Nil
Post-plant Pre -emergent	Grasses and some broadleaf	Imazethapyr ²	Spinnaker [®] 700WDG	100-140 g/ha	Nil
		Flumetsulam	Broadstrike	25 or 50 g/ha	Nil but 4 weeks for grazing
		Metolachlor ²	Dual Gold [®]	1.0-2.0 L/ha	Nil
Post-emergent	Broadleaf and grasses	Imazethapyr	Spinnaker [®] 700WDG	100-140 g/ha plus wetter	Nil
	Broadleaf and grasses	Imazamox	Raptor [®]	50 g/ha plus wetter	Nil but 4 weeks for grazing
	Grasses	Butroxydim	Factor WG [®]	120-180 g/ha plus oil	Nil but 14 days for grazing
	Grasses	Clethodim	Select [®] 240g/L	250-500 mL/ha depending on weed growth stage (i.e. 250-375 for 2-5 leaf, 375-500 for >5 leaf)	Nil for harvest, 21 days for grazing
	Grasses	Fluazifop	Fusilade Forte [®]	0.82-1.65 L/ha plus wetter	17 weeks and 7 weeks for grazing
	Grasses	Haloxyfop	Verdict [®] 520	100-150 mL/ha plus wetter	Nil and 28 days for grazing
	Grasses	Quizalofop	Targa [®]	250-1000 mL/ha plus wetter/oil	Nil and 28 days for grazing
	Grasses	Sethoxydim	Sertin [®]	1.0 L/ha plus oil	Nil and 21 days for grazing
	Broadleaf ³	Acifluorfen ⁴	Blazer	1.0 – 2.0 L/ha	Nil
Broadleaf ³	Bentazone	Basagran [®]	1.5-2.0 L/ha	8 weeks	

1 Should be thoroughly incorporated prior to planting (recent mill mud applications or high trash levels will substantially reduce efficacy)

2 This product requires rain/irrigation to activate the chemical. No WHP for harvest. Do not graze or cut for stock food for 13 weeks after application.

3 Broadleaf weeds should be very small (up to 4 leaf stage, and up to 8 leaf stage for some broadleaf weeds)

4 Blazer can cause severe leaf burn in soybeans, consult your agronomist before use

Note the very long withholding period (WHP) of some of the herbicides (Fusilade, Targa, Basagran).

For specific rates and information – always refer to the label instructions provided by the supplier.

Ensure you investigate all chemicals before use as some have significant plant back periods for other crops that you may be using in rotation.⁶

⁶ Australian Oilseeds Federation (2013), Better Soybeans manual http://www.australianoilseeds.com/soy-australia/Soybean_Production

6.2 Post-plant pre-emergent herbicides

Some broadleaf weeds, nut grass and barnyard grass may be controlled with a pre-emergent application of Spinnaker® 700 herbicide, surface applied immediately post planting. For best results, Spinnaker® also requires a fine seedbed and rainfall for incorporation. This product may also be used very effectively as a post emergent spray.

6.3 In-crop herbicides: knock downs and residuals

Ideally all weeds should be controlled when small to limit any opportunities to compete with the young soybean crop.

Grasses and broadleaf weeds can be controlled post-emergence, preferably as early as possible after the weed emergence. The window to control broadleaf weeds is very small and best results are obtained on weeds less than four leaf stage. A delayed spray may result in greater yield loss because of the herbicide will not achieve a suitable kill of the rapidly growing weed at label rates.

Post-emergent broadleaf weeds (Table 2) may be controlled with Spinnaker®, Broadstrike®, Basagran®, Blazer® and Raptor®. Mixtures of Basagran® and Blazer® are commonly used to increase the spectrum of activity.

Basagran® and Blazer® are best sprayed early in the morning with high humidity. Note that Blazer® will commonly cause severe phytotoxicity (leaf burning) the day following spraying, however this effect is transitory and has no impact on yield. This effect is worse when humidity is low. Blazer® is the only product that will take leguminous weeds (*Sesbania*, etc) out of soybeans.

For broadleaf weed control, Spinnaker® can be broadcast sprayed immediately post sowing or post crop emergence over small weeds in the 2-4 leaf stage. For best results, add Liase and recommended spray adjuvants. Note that Spinnaker has very long (up to 27 months) recropping intervals for some rotational crops – always check the label prior to use. Raptor is another option with a shorter plant back period to Spinnaker.

Table 2: Post-emergent broadleaf herbicides registered for weed control in soybeans. For specific information – always refer to the product label*

*Suppression

Weed	Basagran®	Spinnaker®	Blazer®	Raptor®	Broadstrike®
Amaranthus			R + wetter	R + wetter	
Annual ground cherry	R		R + wetter		S* + wetter
Anoda weed	R	R + wetter		R + wetter	S* + wetter
Apple of Peru	R	R + wetter	R + wetter		
Bathurst burr	S*	R + wetter			
Bellvine	R	R + wetter	R + wetter	R + wetter	
Blackberry nightshade	S*		R + wetter	R + wetter	
Bladder ketmia			R + wetter		S* + wetter post-emerg weed
Caltrop				R + wetter	S* up to 4 leaf
Fat hen		R + wetter		R + wetter	R +wetter
Jute		R + wetter	R + wetter		
Mintweed					
Mustard				R + wetter	
Nogoora burr	R		R + wetter	R + wetter	
Pigweed (red)			R + wetter		S* +wetter
Pigweed (black)			R + wetter		S*
Sesbania pea			R + wetter		

Weed	Basagran®	Spinnaker®	Blazer®	Raptor®	Broadstrike®
Thorn apple	R	R + wetter	R + wetter	R + wetter Only fierce thornapple, not common thornapple	S* +wetter, only fierce thornapple Qld only, not common thornapple
Wild turnip				R + wetter	
Wild gooseberry		R + wetter	R + wetter	R + wetter	S* +wetter
Wireweed				R + wetter	

Post-emergent grass herbicides are most effective on actively growing grasses at the three to five leaf stage before tillering commences, however they have a far wider application window than the post emergent broadleaf herbicides and can still be used effectively on quite large grasses. Always read and follow the label exactly for best results and use recommended spray adjuvants.⁷

6.4 Integrated Weed Management (IWM)

The principle of Integrated Weed management (IWM) is that crop weeds are managed most effectively using a combination of chemical and non-chemical methods. Good weed management relies on crop rotations and specific management strategies targeted at reducing the seed banks of problem weeds.

To manage weeds efficiently:

- Plan weed management strategies and control weeds before planting.
- Select crop, planting rate and inter-row cultivation to reduce reliance on chemicals where appropriate.
- Identify weeds and understand their biology before applying herbicides.
- Always refer to the herbicide manufacturer's product label before use.
- Apply herbicides at the right time and at the right rate.
- Use effective application equipment.
- Keep accurate records.
- Ensure herbicide modes of action are rotated each season.

An important approach of IWM is to look at the farm as a system and to control weeds before you plant.⁸

6.5 Weed control in organic soybeans

There is no comprehensive 'recipe' for weed control in organic crops. Organic methods used to control weeds do not include the use of synthetic herbicides. Weed control systems must be developed to suit the particular weed spectrum, cropping rotation sequence and farming system, cost structure and so on.

In conventional and organic agriculture there is no substitute for the time-honoured practice of controlling crop weeds in the fallow to reduce the weed seed bank as well as in-crop. This reduces the overall weed seed burden, reducing the need for in-crop weed control methods such as inter-row cultivation, and hand weeding. Increasing crop competition, by increasing the planting rate can assist minimising weed growth, however cannot be relied on as a sole control measure.

When budgeting for organic crops, don't overlook the cost of hand weeding, an essential ingredient not only for the current crop but also for the future success of the organic

⁷ Australian Oilseeds Federation (2013), Better Soybeans manual http://www.australianoilseeds.com/soy_australia/Soybean_Production

⁸ Australian Oilseeds Federation (2013), Better Soybeans manual http://www.australianoilseeds.com/soy_australia/Soybean_Production

farming system. Organic growers need to use inter-row cultivation to control weeds, but will often have to employ a team of chippers to remove weeds in the plant row.

Alternative non-chemical weed controls such as flame, hot water and steam treatments are not yet fully developed for wide usage. However, development work continues and such techniques are expected to become more effective and economic in the near future.⁹

6.6 Harvest-aid herbicides – desiccating the crop

Herbicides are commonly applied to soybean and other pulse crops as harvest aids to ensure that a uniform, dry and predominately leaf free crop is presented to the header. Herbicides are also used to desiccate green weeds, which are likely to cause harvesting difficulties. These difficulties include mechanical blockages in the header, grain quality downgrading from contamination by declared weed seeds and from staining of the harvested grain by the weed sap. Desiccants are also applied for crops that display uneven maturity.¹⁰

The two options available to growers are:

- Diquat (Reglone®) is applied when 80% of pods are yellow/brown and seeds are ripe, yellow and pliable. Harvest 4–7 days after spraying.
- Weedmaster Argo or Weedmaster DST is applied only after seed pods have lost all green coloration and 80%–90% of leaves have dropped. Do not apply to crops grown for seed or sprouting. Do not harvest within seven days of application.

See also [GrowNotes Soybeans, Section 12, Harvest](#).

⁹ Australian Oilseeds Federation (2013), Better Soybeans manual http://www.australianoilseeds.com/soy_australia/Soybean_Production

¹⁰ Australian Oilseeds Federation (2013), Better Soybeans manual http://www.australianoilseeds.com/soy_australia/Soybean_Production

SECTION 7

Insect control

Soybeans can be attacked by pests at any stage from seedlings to harvest, but are most attractive to insect pests from flowering onwards. Soybeans are more tolerant of insect damage than most other grain legumes and noticeable damage (particularly leaf damage) does not necessarily result in yield loss. The basic Integrated Pest Management (IPM) strategy for soybeans is to avoid non-selective pesticides for as long as possible to foster a build-up of predators and parasites (i.e. to 'go soft early'). This buffers the crop against pest attack during later crop stages, and greatly reduces the risk of subsequent heliothis, silverleaf whitefly and mite attack. However many pests have a major impact on yield and quality, and intervention with pesticides is frequently unavoidable.

Major pests in soybeans are heliothis (heliocis), podsucking bugs, and potentially silverleaf whitefly. Other lesser and/or infrequent, but damaging pests, include loopers, grass blue butterfly, cluster caterpillar, soybean moth, soybean aphid, mirids, monolepta beetle and crickets. Note that beanfly and bean podborer, both major pests in other summer pulses, are not a threat to soybeans.

Soybeans are more attractive to a range of foliage-feeding pests (e.g. numerous loopers, grass blue butterfly, and leaf miners) than other summer pulses. During the vegetative stage, 33% leaf defoliation can be tolerated without yield loss, although this falls to 16% during pod set.

Heliothis can attack at any stage from seedlings onwards. High heliothis populations have a severe impact on vegetative crops because they destroy the plant's axillary buds, the precursors to the floral buds. Soybeans can compensate for considerable damage during early podding because they set a large number of 'reserve pods' which can replace pods eaten by heliothis.

Podsucking bugs (PSB) are major soybean pests. The most damaging species are the green vegetable bug (*Nezara viridula*), the large and small brown bean bugs (*Riptortus* and *Melanacanthus* sp. respectively) and the redbanded shield bug (*Piezodorus oceanicus*). Soybeans can compensate for potential yield loss due to bug damage, but bug damage reduces seed quality. Only 3% seed damage is tolerated in edible soybeans, and the action threshold for PSB in edibles is based on 2% damage.

Silverleaf whitefly (SLW) are a potential threat to soybeans. However the introduced SLW parasite *Eretmocerus hayati*, native parasites and predators, have largely stabilised whitefly populations in most regions in most years. Note that beneficials targeting SLW are only effective if they are not disrupted by non-selective pesticides, particularly in vegetative and flowering crops.

Soybean aphids are present in most crops but are mostly kept in check by ladybirds and hoverfly larvae. However above-threshold soybean aphid populations (>250 aphids per plant) can have a devastating impact on yield and harvest maturity.

Mirids have far less impact in soybeans than mungbeans. Up to 5 mirids/m² have no impact on yield.

Other pests that spasmodically occur in very damaging numbers include monolepta beetle in coastal sugar-growing regions, and soybean moth larvae (which mine inside the leaves) in all regions.

i More information

H Brier, M Miles (2015), Emerging insect threats in northern grain crops:

<https://www.grdc.com.au/Research-and-Development/GRDC-Update-Papers/2015/07/Emerging-insect-threats-in-northern-grain-crops>

The Beatsheet, Insect pest management for Australia's Northern Region: <http://thebeatsheet.com.au/>

GRDC (2013) Stem fly outbreak batters soybean crops: <http://www.grdc.com.au/Media-Centre/Media-News/North/2013/04/stem-fly-outbreak-batters-soybean-crops>

Scout crops regularly with a beat sheet, at least weekly pre flowering, and twice weekly post flowering. In a typical soybean crop, budget for one deltamethrin spray for podsucking bugs, and one helioverpa spray after flowering, preferably with a moderately selective pesticide such as indoxacarb. Check all registrations regularly on the APVMA/PUBCRIS website and only use products registered in soybeans.¹

7.1 Name and description of pest (identification)

7.1.1 *Helicoverpa* (*Helicoverpa armigera*, *H. punctigera*)

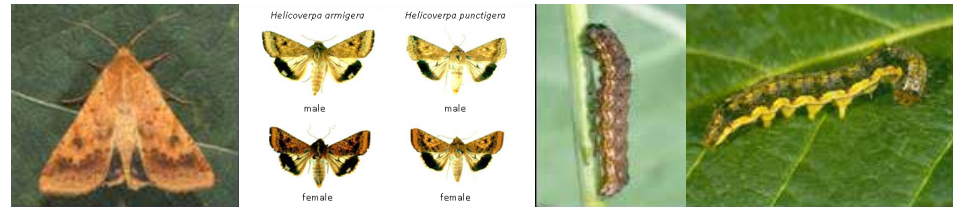

Figure 1: *Helicoverpa armigera* female moth, *Helicoverpa armigera* and *H. punctigera* moths. Also, medium large (18 mm) and large *H. armigera* larvae (36 mm). Note the pale spot in the dark perimeter band of *H. armigera*'s hind wing, (not present in *H. punctigera*), the larvae's uniform body thickness, 4 pairs of abdominal prolegs, sparse hairs, and wide pale lateral band. (Photo: Australian Oilseeds Federation)

Pest status: *Helicoverpa* can severely damage all crop stages and all plant parts of soybeans. Vegetative soybeans are more attractive to *helicoverpa* than the vegetative stages of other summer pulses and can even be damaged during the seedling stage. However the crop is at greatest risk of attack from flowering to late podfill. In sub-coastal and inland southern Queensland, summer legumes are at greatest risk from *H. armigera* from mid December onwards.

Identification: *Helicoverpa* larvae can be confused with loopers, armyworms or cluster caterpillars. Their colour is very variable ranging from green to orange to brown to black. Look for a broad pale band along each flank, a lack of large dark spots, four pairs of abdominal prolegs, sparse body hairs and a parallel body. Young *H. armigera* larvae have a dark saddle behind the head while *H. punctigera* larvae don't. Large *H. armigera* larvae have white hairs behind the head. Larvae can reach 35 mm in length.

Helicoverpa moths have a 35 mm wingspan. The forewings of males are straw-colour and those of females are brown. Forewings of both sexes have dark markings. Hindwings are pale cream with a wide, dark outer band. *H. armigera* has a distinctive pale spot in the hindwing's dark outer band. This spot is missing in *H. punctigera*.

Damage: *Helicoverpa* defoliation is characterised by rounded chew marks and holes (loopers make more angular holes). *Helicoverpa* also attack auxiliary buds and terminals in vegetative crops. This type of damage can have a severe impact on subsequent podset, particularly if there are high populations in seedling or drought-stressed crops. Early terminal and bud damage can also result in pods being set closer to the ground. Such pods are more difficult to harvest. In drought stressed crops, the last soft green tissue is usually the vegetative terminals, which are thus more likely to be totally consumed than in normally growing crops.

Once crops reach flowering, larvae focus on buds, flowers and pods. Young larvae are more likely to feed on vegetative terminals, young leaves and flowers before attacking pods. Small pods may be totally consumed by *helicoverpa*, but larvae target seeds in large pods. Crops are better able to compensate for early than late pod damage. However in drought-stressed crops, early damage may delay or stagger podding with subsequent yield and quality losses. Damage to well-developed pods also results in the weather staining of uneaten seeds due to water entering the pods.

¹ Australian Oilseeds Federation (2013), Better Soybeans manual http://www.australianoilseeds.com/soy-australia/Soybean_Production

Monitoring: Beat sheet sampling is the preferred sampling method for medium to large helioverpa larvae. Small larvae should be scouted for by inspecting (opening) vegetative terminals and flowers. Damage to vegetative terminals is often the first visual clue that helioverpa larvae are present. Soybeans should also be scouted for eggs and moths, to pinpoint the start of infestations and increase the chance of successful control.

Inspect crops weekly twice weekly from early budding until late podding. The sampling frequency during the vegetative stage has been increased to increase the chance of detecting caterpillar pests while they are still small enough to control with biopesticides.

Sample six widely-spaced locations per crop management unit. Take 5 one-metre long samples at each site with a 'standard' beat sheet. Convert larval counts/m to larvae/m² by dividing counts by the row spacing in metres.

Beat sheet sampling may only detect 50% of small larvae in vegetative and podding soybeans, and 70% during flowering, as they feed in sheltered sites such as leaf terminals. However many of these small larvae will be lost to natural mortality factors before they reach a damaging size and in most crops, and this mortality will cancel out any sampling inefficiencies. Altacor provides outstanding and extended crop protection with low toxicity to beneficials.

Thresholds: In vegetative crops, thresholds for many leaf feeding pests are expressed as % tolerable defoliation or % tolerable terminal loss. Before flowering, soybeans can tolerate up to 33% leaf loss without loss of yield. However recent data (Rogers 2010) shows that helioverpa populations infecting less than 33% damage can cause serious yield loss, because the larvae not only feed on leaves, but also attack terminals and auxiliary buds. The data indicates an economic threshold of approximately 7 helioverpa larvae per square metre (7.5/m²) in mid to late vegetative soybeans. This threshold should be lowered in early vegetative or stressed crops. Helioverpa thresholds for podding soybeans currently range from 1-2 larvae/m² (depending on crop value and pesticide cost).

Chemical control: Prior to flowering, biopesticides, particularly helioverpa nuclear polyhedrosis virus (NPV), are recommended in preference to chemical insecticides. This helps conserve beneficial insects to buffer crops against helioverpa attack during the susceptible reproductive stages, and avoids faring of other pests such as silverleaf whitefly and mites.

Cultural control: Where possible, avoid successive plantings of summer legumes. Good agronomy and soil moisture are crucial as large, vigorously growing plants suffer less defoliation for a given helioverpa population and have less risk of terminal damage.

In water-stressed crops, terminals are more attractive to larvae than wilted leaves. Vigorously growing plants with adequate available moisture are better able to replace damaged leaves and to compensate for flower and pod damage.

Natural enemies: The number of beneficial insects varies with crop age, from crop to crop, region to region, and from season to season. The combined action of a number of beneficial species is often required to have a significant impact on potentially damaging helioverpa populations. It is therefore desirable to conserve as many beneficials as possible.

Natural enemies of helioverpa include predators of eggs, larvae and pupae, parasites of eggs, larvae and pupae, and caterpillar diseases. Predatory bugs and beetles attacking helioverpa eggs and larvae include: spined predatory bug, glossy shield bug, damsel bug, bigeyed bug, apple dimpling bug, assassin bugs, red and blue beetle, and predatory ladybirds. Other important predators include ants, spiders and lacewings. Egg parasites include the tiny Trichogramma spp. wasps. Caterpillar parasites include Microplitis, Heteropelma and Netelia sp. wasps and several species of tachinid flies including Carcelia sp. The banded caterpillar parasite Ichneumon promissorius is actually a pupal parasite.

With the exception of the egg parasites and *Microplitis*, most parasites don't kill *helicoverpa* until they reach the pupal stage. Predatory earwigs and wireworm larvae are significant predators of *helicoverpa* pupae.

Naturally occurring caterpillar diseases frequently have a marked impact on *helicoverpa* in summer legumes. Outbreaks of NPV are frequently observed in crops with high *helicoverpa* populations.²

7.1.2 Pod-sucking bugs

Pod-sucking bugs can move in at budding but significant damage is confined to pods early podfill to harvest maturity. While bugs start breeding as soon as they move into flowering crops, nymphs must feed on pods to complete their development. Bugs cause shrivelled and distorted seed, and can severely reduce yield and seed quality. Bugs can even damage seeds in pods that are nearing harvest maturity. Late bug damage reduces seed quality but not yield. As only 3% seed damage is tolerable in culinary soybeans, bug thresholds are based on seed quality, not seed yield.

A number of pod-sucking bug species attack soybeans and include:

- green vegetable bug
- redbanded shield bug
- large brown bean bug
- small brown bean bug
- brown shield bug

The green vegetable bug (GVB) and the brown bean bugs are equally damaging to crops, while the damage potentials of the redbanded and brown shield bugs are 0.75 and 0.2 of that of a GVB respectively. Nymphs of all species are less damaging than adults. While 1st instar nymphs cause no damage, subsequent instars are progressively more damaging with the 5th and final instar being nearly as damaging as adults. To determine the damage potential of mixed bug species populations, convert all species (adults and nymphs) to GVB adult equivalents (GVBAEQ).³

Green vegetable bug (GVB), Nezara viridula



Figure 2: Green vegetable bug adult (15 mm), 4th instar nymphs (8 mm) and egg raft (about to hatch). (Photo: Australian Oilseeds Federation)

Distribution: GVB was first recorded in Australia in 1916 (an accidental introduction) and is now found in all Australia states and territories.

Pest status: Major, widespread and regular. GVB is the most damaging pod-sucking bug in pulses, due to its abundance, widespread distribution, rate of damage and rate of reproduction. It is one of the most recognised agricultural pests in Australia.

Identification: Adult GVB are bright green and shield-shaped, and are 13-15 mm long. Adult GVB have three small white spots at the front of the scutellum (between their shoulders). Yellow and orange GVB colour variants are occasionally encountered. Over

² Australian Oilseeds Federation (2013), Better Soybeans manual http://www.australianoilseeds.com/soy_australia/Soybean_Production

³ Australian Oilseeds Federation (2013), Better Soybeans manual http://www.australianoilseeds.com/soy_australia/Soybean_Production

wintering adults are purple brown in colour. GVB emit a foul smell when disturbed to deter predators.

GVB eggs are laid in rafts (50-100 eggs per raft) and are circular in cross section. Newly laid eggs are cream but turn bright orange prior to hatching. Parasitised GVB eggs are black.

GVB nymphs vary in colour. Newly hatched nymphs (1.5 mm long) are orange and brown (sometimes black). Later instars are green or black, with white, cream, orange and red markings. Final (5th) instar nymphs have fewer spots (more base colour, green to black), and have prominent wing bugs. Younger nymphs are round or oval rather than shield shaped and usually aggregate in large clusters. Older nymphs are more widely dispersed.

Life cycle: Eggs take 6 days to hatch at 25°C. Nymphs don't usually reach a damaging size until mid to late pod-fill. Usually only 1 generation develops on a summer legume crop. Nymphs require pods containing seeds to complete their development and the podding phase of most summer legumes is only slightly longer in duration than GVB's life cycle. There are 5 nymphal instars with a total development time of about 30 days. Development is faster at temperatures higher than 25°C but there is considerable nymphal and adult mortality at temperatures over 35°C.

Risk period: Adult bugs typically invade summer legumes at flowering, but GVB is primarily a pod feeder with a preference for pods with well developed seeds. Nymphs are unable to complete their development prior to pod-fill. Soybeans remain at risk until pods are too hard to damage (i.e. very close to harvest). Damaging populations are typically highest in late summer crops during late pod-fill (when nymphs have reached or are near adulthood).

Damage: Pods most at risk are those containing well-developed seeds. While GVB also damages buds and flowers, soybeans can compensate for this early damage. Damage to young pods cause deformed and shrivelled seeds and potentially reduces yield, although this is often compensated for by an increase in weight of undamaged seeds. Seeds damaged in older pods are blemished and difficult to grade out, reducing harvested seed quality, particularly that destined for human consumption (edibles). GVB can even damage seeds in 'close-to-harvest' pods (i.e. pods that have hardened prior to harvest). Bug damaged seeds have increased protein content but reduced oil content and a shorter storage life (due to increased rancidity). Bug damaged seeds are frequently discoloured, either directly as a result of tissue breakdown, or because of diseases such as *Cercospora* (purple seed stain), which may gain entry where pods are pierced by bugs.

Small GVB nymphs are far less damaging than older nymphs which become progressively more damaging as they progress to adulthood. Final instar nymphs are nearly as damaging as adults.

Sampling and monitoring: Inspected crops twice weekly for GVB from flowering until close to harvest. Sample crops for GVB in the early to mid morning. Beat sheet sampling is only effective monitoring method. The standard sample unit is five one metre non-consecutive lengths of row within a 20 m radius. Convert all bug counts per row metre to bugs/m² by dividing counts per row metre by the row spacing in metres.

At least six sites should be sampled throughout a crop management unit to accurately determine adult GVB populations. GVB nymphs are more difficult to sample accurately as their distribution is extremely clumped, particularly during the early nymphal stages (1st-3rd instars). Ideally, at least 10 sites (with five non-consecutive row metres sampled per site) should be sampled to adequately assess nymphal populations.

Thresholds: Pod-sucking bug thresholds in edible or culinary soybeans (destined for human consumption) are determined by seed quality, the maximum bug damage permitted being only 3%. GVB thresholds typically range from 0.3-0.8/m² depending on the crop size (seeds per m²) and when bugs are detected. Because thresholds are determined by % damage, the larger a crop (the more seeds per unit area), the more

bugs that are required to inflict critical (threshold) damage, and the higher the threshold. For crushing and stockfeed soybeans with lesser quality requirements, the threshold is doubled. Thresholds are expressed in adult equivalents.

Chemical control: Bugs should be controlled during (but not prior to) early podfill before nymphs reach a damaging size. Pesticides are best applied in the early to mid morning to contact bugs basking at the top of the crop canopy.

Cultural control: Avoid sequential plantings of summer legumes as bug populations will move progressively from earlier to later plantings, eventually building to very high levels. Avoid cultivar and planting time combinations that are more likely to lengthen the duration of flowering and podding.

Natural enemies: GVB eggs are frequently parasitised by a tiny introduced wasp *Trissolcus basalis*. Parasitised eggs are easily recognised as they turn black. GVB nymphs are attacked by ants, spiders and predatory bugs. Final (5th) instar and adult GVB are parasitised by the recently introduced tachinid fly (*Trichopoda giacomellii*).⁴

Redbanded shield bug (RBSB), Piezodorus oceanicus

Redbanded shield bugs in Australia were previously classified as *Piezodorus hybneri* and more recently as *P. grossi*.



Figure 3: Red-banded shield bug adult (female), nymph and twin-row egg raft with hatching nymphs. (Photo: Australian Oilseeds Federation)

Pest status: Major, widespread, regular. RBSB is 75% as damaging as GVB in summer pulses but is usually not as abundant. However, it is more difficult to control with current pesticides.

Identification: Adults are similar in shape to GVB but are smaller (8-10 mm long) and paler, with a noticeable band across their shoulders. Females have a pink (not red) band across their shoulders. In contrast, males have an off-white band across the shoulders and pale yellow lines along their side.

Eggs are laid in distinctive twin row rafts with 15-40 dark elliptical eggs (in cross section), ringed by small spines. Newly hatched nymphs are orange with black markings and similar to newly hatched nymphs of many other shield bugs. Larger nymphs are pale green with dark red and brown markings in the centre of their back. Late autumn nymphs may turn a pale pink-brown colour.

Damage: Damage is similar to that caused by GVB, with early damage reducing yields, and later damage reducing the quality of harvested seeds. Thresholds: Convert to GVB equivalents to determine damage potential ie. multiply counts by 0.75.

Monitoring: As for GVB. Look for the distinctive twin-row egg rafts that indicate RBSB presence.

Chemical control: No insecticides are specifically registered against RBSB in Australia. Recent trials suggest pesticides currently registered against GVB are ineffective against RBSB. However, control can be improved, albeit to a moderate 50-60%, with the addition of a 0.5% salt (NaCl) adjuvant.

Natural enemies: Spiders, ants, and predatory bugs are major predators of RBSB, particularly of eggs and young nymphs with mortality of these stages sometimes

⁴ Australian Oilseeds Federation (2013), Better Soybeans manual http://www.australianoilseeds.com/soy-australia/Soybean_Production

exceeding 90%. Eggs may be parasitised by the tiny wasp, *Trissolcus basalis*. Adults are infrequently parasitised by the recently introduced tachinid fly *Trichopoda giacomellii*.⁵

Large brown bean bug, Riptortus serripes

Hemiptera: Alydidae

Distribution: Native to Australia.

Similar *Riptortus* species occur in Asia, India and Africa.

Pest status: Major. As damaging as GVB. More frequent on the coast, with a liking for the *Vigna* legumes (e.g. adzukis, cowpeas and mungbeans, as well as soybeans).

Identification: An elongated dark brown bug, 16-18 mm long (not including legs and antennae) with long antennae and a bright yellow stripe along each side. This stripe is more pronounced in males and less distinct in females, which have a 'rounder' body than males. *Riptortus serripes*'s body narrows in the middle and it has a spine on each 'shoulder'. It also has large robust and spiny hindlegs. When it is flying, the bright orange top of the abdomen is revealed.

Nymphs are dark brown and similar in outline to ants. However close inspection shows they lack the very narrow 'waist' and biting mouthparts (jaws) typical of ants.

Eggs are a dark purple-brown in colour and are laid singly or in small clusters. They are slightly elliptical with a flattened top and rounded base and are 1.5 mm long.



Figure 4: Adult female (16 mm) (left). 4th instar nymph (9 mm) (right).

May be confused with:

- Small brown bean bug, *Melanacanthus scutellaris*, which is considerably smaller (10-12 mm) and not as robust.
- Rice or paddy bug, *Leptocorisa acuta* (Thunberg). Rice bugs are pale green or brown, reach 15 mm in length, and are very slender with thin hindlegs.

Life cycle: *Riptortus* invade summer legumes at flowering and proceed to feed and lay eggs. This pest lays scattered single eggs. There are 5 nymphal stages with nymphs reaching a damaging size during mid to late podfill. Development times for *Riptortus* eggs and nymphs are about 8 and 17 days respectively (25 days total) at 26°C. Overwintering *R. serripes* shelter in curled up dead leaves.

Host range, risk period and damage: As for GVB. *R. serripes* is as damaging as GVB.

Monitoring: The beat sheet method is not totally satisfactory for *R. serripes* because it is very flighty, particularly during the hotter parts of the day. Crops should be sampled during the early morning. Crop scouts should also familiarise themselves with the appearance of flying (and escaping) *Riptortus* adults and include these in sampling counts.

⁵ Australian Oilseeds Federation (2013), Better Soybeans manual http://www.australianoilseeds.com/soy_australia/Soybean_Production

Chemical control: *R. serripes* is likely to be controlled by synthetic pyrethroids which are registered against GVB.⁶

Small brown bean bug, Melanacanthus scutellaris
 Hemiptera: Alydidae



Figure 5: Female (12mm) (left), 1st instar nymph (middle), eggs (right). (Photo: Australian Oilseeds Federation)

Distribution: Native to Australia.

Pest status: Major. This pest can be as damaging as GVB.

Identification: The small brown bean bug is an elongated brown bug, 10-12 mm long (body only) with long antennae and a cream stripe along each side. This stripe is often less distinct in females, which are 'rounder' than males. Males also have a prominent pale patch in the scutellum. The small brown bean bug has a short spine on each 'shoulder' (less pronounced than on *Riptortus sp.*), and moderately robust and spiny hind legs (thinner than those of *Riptortus sp.*).

Nymphs are dark brown to black and similar in outline to ants. However close inspection shows they lack the very narrow 'waist' typical of ants. The shiny olive green eggs are laid in small clusters. The eggs are slightly elliptical with a flat top and a rounded base and are 1.0 mm long.

Life cycle: Small brown bean bugs invade summer legumes at flowering where they commence feeding and lay eggs. This bug lays scattered single eggs (up to several hundred per female). There are 5 nymphal stages and nymphs usually reach a damaging size to coincide with mid to late podfill. Development times for eggs and nymphs are about 6 and 20 days respectively at 26°C.

Damage: The small brown bean bug is as damaging as GVB and the large brown bean bug.

Monitoring and control: As for the large brown bean bug *Riptortus serripes*.⁷

Brown shield bug, Dictyotus caenosus (Westwood)
 Hemiptera: Pentatomidae



Figure 6: Eggs, brown shield bug (8 mm), 4th instar nymphs, glossy shield bug (12 mm) – a predator. (Photo: Australian Oilseeds Federation).

Distribution: Native to Australia.

⁶ Australian Oilseeds Federation (2013), Better Soybeans manual http://www.australianoilseeds.com/soy_australia/Soybean_Production

⁷ Australian Oilseeds Federation (2013), Better Soybeans manual http://www.australianoilseeds.com/soy_australia/Soybean_Production

Pest status: Minor but difficult to control pest.

Identification: Brown shield (or brown stink) bug (BSB) adults are shield shaped and are matt mid brown (ie. not glossy). At 8 mm long, they are noticeably smaller than the green vegetable bug.

Newly hatched nymphs are orange with black markings and similar to newly hatched nymphs of many other shield bugs. Larger nymphs have a dark brown (sometimes almost black) head and thorax, and a pale brown abdomen with transverse dark brown and pale (almost white) markings at its centre. There is also a transverse pale band at the front of the abdomen. BSB lays eggs in either small twin rows or small irregular rafts containing 10-16 eggs. Eggs are pale cream and similar in shape to GVB eggs.

May be confused with: Glossy shield bugs, (*Cermatulus nasalis*) which are slightly larger and a predatory species. Brown shield bug eggs and nymphs are distinct from those of *Cermatulus*.

Life cycle: BSB invade summer legumes at flowering and proceed to feed and lay eggs. Nymphs usually reach a damaging size during mid to late podfill. There are 5 nymphal stages.

Damage and control: The brown shield bug is less damaging than other bugs with only 20% of GVB damage recorded. There is anecdotal evidence this species is (like *Piezodorus*) also difficult to control with current pesticides but that control can be improved (to 50-60%) with the addition of a 0.5% salt (NaCl) adjuvant.⁸

7.1.3 Silverleaf whitefly (SLW), *Bemisia tabaci* biotype B.

Silverleaf whitefly (SLW) poses a threat to soybeans in most regions in NE Australia. However the exotic SLW parasite *Eretmocerus hayati*, together with native parasites and predators, will stabilise SLW populations, provided they are not disrupted by the overuse of non-selective pesticides.

Distribution: SLW is widespread in tropical and subtropical Australia. In southern Queensland and northern NSW, SLW is most abundant in coastal regions with milder winters and a continuum of hosts. However, SLW is also abundant in more-inland regions such as the Emerald irrigation area of central Qld., the St George irrigation area of SW Qld., and the north-west slopes of NSW.

Pest status: Always a potential major risk in a susceptible crop such as soybeans, particularly in regions where broad spectrum insecticides are widely used.



Figure 7: SLW adults (1.2 mm) and pupating (red eye) nymph on leaf underside. Note the gap between the adult's wings.

⁸ Australian Oilseeds Federation (2013), Better Soybeans manual http://www.australianoilseeds.com/soy_australia/Soybean_Production



Figure 8: SLW adults sheltering under soybean leaflet.



Figure 9: Green house whitefly adult and GHW nymph. Note the nymph's long filaments, absent on SLW. (Photos: Australian Oilseeds Federation)

Identification: Adults are 1.5 mm long with powdery white wings and a pale orange body. Their folded wings don't quite touch revealing the body when viewed from above. SLW eggs are small and spherical and sit on a short stalk. Eggs are initially pale yellow but turn brown with age. High egg densities give the impression the leaf's (undersides) are covered with brown velvet. The nymphs (or scales) are pale cream/yellow and are flat and oval shaped. Nymphs cease feeding and metamorphose to winged adults during the late 4th instar which is called the pupa or 'red eye' (because of prominent red eye spots). The lifecycle takes 18-30 days from egg lay to adult depending on temperature.

May be confused with: SLW can only be differentiated from other strains of *Bemisia tabaci* by biochemical testing. The larger greenhouse whitefly (1.5mm) has wings that obscure the body when viewed from above and a nymphal stage with long waxy filaments.

Host range: Of the summer pulses, soybeans and navy beans are preferred SLW hosts. Other favoured hosts include capsicums, cotton, cucurbits, dolichos, milk thistle, poinsettia, rattlepods, sunflowers, sweet potatoes and tomatoes.

Risk period: Soybeans maturing during late summer and autumn are at greater risk of attack because invading SLW have had more time to increase from low over-wintering populations. As a rule, the earlier crops are infested the greater the risk. Crops remain attractive to SLW until mid pod-fill. As photosynthetic assimilates are redirected from leaves to fill the pods, leaves become unattractive to SLW and adults leave the crop to find more attractive hosts.

Damage: SLW can reduce plant vigour and yield by the sheer weight of numbers removing large amounts of plant photosynthate from the leaves. Severe infestations in young plants can stunt plant growth and reduce yield potential. Later infestations can reduce the number of pods set, seed size, and seed size uniformity, thus reducing yield and quality. As a rule, the impact of SLW is worst in drought stressed crops. In heavily infested soybeans, both pods and seeds are often unusually pale. While seed colour is

unlikely to be of concern in grain soybeans (harvested seeds being naturally pale), pod and seed discolouration are a major marketing problem where pods are picked green (e.g. vegetable soybeans and green beans).

SLW often secrete large amounts of sticky honeydew. Adult females produce more honeydew than other stages and nymphs produce more honeydew when feeding on stressed plants. Honeydew in itself is not a major problem, but sooty mould developing on honeydew shields leaves from sunlight and reduces photosynthesis. Sooty mould's impact is greatest from early to mid podfill when SLW activity is greatest at the top of the canopy (i.e. on leaves with the greatest photosynthetic activity). Rain and overhead irrigation wash honeydew off leaves, lessening the risk of sooty mould.

Monitoring: SLW eggs, nymphs and resting adults are mainly found on the underside of leaves. Flying SLW adults are readily observed when crops with high populations are disturbed. The presence of honeydew and sooty mould may also indicate SLW attack, but can be due to aphid feeding. SLW eggs are laid on younger leaves, so by the time eggs develop to large nymphs in crops with high growth rates, leaves with the greatest visible SLW nymphal activity are further down the plant. This may be as many as 5-7 nodes below the plant top. As vegetative growth slows, plant nodes with greatest nymphal activity move progressively upwards to the canopy top.

Thresholds and chemical control: There are no validated thresholds for SLW and no pesticides are specifically registered for SLW control in summer pulses in Australia. Use the softest options possible for other pests, especially early in the life of the crop, to encourage SLW parasites and predators.

Cultural control: Where possible, avoid successive plantings of summer pulses to prevent movement from early to late crops. Avoid planting summer pulses in close proximity to earlier maturing SLW hosts such as cotton and cucurbits. Where damaging SLW populations are evident in other crops early in the season (early summer), or in regions with a history of consistently damaging widespread SLW activity, consider planting a pulse type less attractive to SLW (e.g. mungbeans or adzukis (*Vigna sp.*), rather than soybeans). However in most regions, this should not be necessary.

Control SLW weed hosts such as rattlepod and milk thistle. Irrigate crops to reduce moisture stress which makes crops more susceptible to SLW damage. Overhead irrigation also washes off sooty mould and drowns adult SLW. Narrow leafed and smooth leafed (less hairy) cultivars may be less attractive to SLW. However, the latter attribute may leave crops more vulnerable to aphid attack.

Natural enemies: SLW nymphs are parasitised by native species of *Encarsia* and *Eretmocerus* (both very small wasps). In the early to mid 2000's, CSIRO made widespread releases of the exotic parasite *Eretmocerus hayati*. The parasite is now well established and, in conjunction with native SLW parasites and predators, has stabilised SLW populations in many soybean crops. Nymphs parasitized by *Eretmocerus* are an opaque honey colour while those parasitized by *Encarsia* are dark. Look for discoloured nymphs to monitor SLW parasitism in your crop.⁹

⁹ Australian Oilseeds Federation (2013), Better Soybeans manual http://www.australianoilseeds.com/soy-australia/Soybean_Production

7.1.4 Soybean stemfly (*Melanagromyza sojae*)



Figure 10: Adult, larvae, parasite and exit hole of Soybean stemfly (*Melanagromyza sojae*)

A major outbreak of this pest occurred in soybeans in the Casino region of NSW in 2013. Since then, stemfly populations have declined in the Casino region, most likely due to parasitism, significant levels of which were observed in late summer of 2013. Stemfly have also been detected in other soybean growing regions, including the South Burnett in South-East Qld, but not in damaging numbers. It is likely that the pest will be always present in coming seasons, but hopefully only periodically in really damaging numbers.

Soybean stemfly adults are small (2 mm) and black with reddish eyes and are very similar to bean fly (*Ophiomyia phaseoli*) which is a major navy bean pest. Eggs are laid in the leaves and larvae tunnel down the petioles to reach the stem. Unlike beanfly, stemfly larvae tunnel in the stem pith and make a distinctive exit hole before pupating. Note that stemfly damage looks very similar to that caused by crown borer and etiology. Note also that the feeding in the pith has little if any effect on plant health.

Many infested crops near Casino exhibited a 'sudden death' syndrome during early podfill (leaf yellowing and plant death). However, the real culprit in many instances was most likely soil borne disease such as charcoal rot and phomopsis. These diseases are triggered by plant stress and inoculum build-up due to successive soybean crops in many paddocks.

There are no well-defined stemfly thresholds. In navy beans the beanfly threshold is one tunnel per plant in seedling plants. But in soybeans, stemfly normally attack older plants. Only spray if stemfly are present in 'reasonable' numbers (numerous larvae per plant) and there are increasing unhealthy plant symptoms that are NOT disease related. Note that diseases such as charcoal rot and phomopsis are manifested by poor root development, distinctive stem discolouration and leaf discolouration and death, and eventual plant death.

If you do spray, target the larvae before they reach the stems. Once inside the stems, larvae cannot be controlled as they are feeding on non-vascular tissue. Note that Casino crops that were sprayed with the beanfly rate of dimethoate (800 mL/ha) in 2013, experienced an explosion of white fly numbers, from already very high levels.

If you do spray, leave an unsprayed strip to evaluate the efficacy of the spray on the pest and plant health, and its impact on secondary pests such as whitefly.¹⁰

¹⁰ H Brier, M Miles (2015), Emerging insect threats in northern grain crops: <https://www.grdc.com.au/Research-and-Development/GRDC-Update-Papers/2015/07/Emerging-insect-threats-in-northern-grain-crops>

7.2 Moderate, less frequent and minor pests

7.2.1 Cluster caterpillar *Spodoptera litura* (often referred to as 'spods')



Figure 11: Egg mass. (Photo: Australian Oilseeds Federation)



Figure 12: *Spodoptera litura* moth. (Photo: Australian Oilseeds Federation)



Figure 13: Small clustering larvae (5 mm). (Photo: Australian Oilseeds Federation)



Figure 14: Large larvae (30 mm). (Photo: Australian Oilseeds Federation)

Distribution: Cluster caterpillar is more common in tropical and coastal soybean growing regions.

Pest status: Moderate. Not quite as damaging as helioverpa and less frequent. It has been reported as causing significant damage to soybeans in coastal Qld.

Identification: Moths are larger than helioverpa with a 40 mm wingspan and brown forewings with criss-cross cream streaks.

The eggs are laid in a furry cream mass on the underside of leaves. Young larvae 'cluster' together and are translucent green with a darker thorax. Middle-sized larvae are smooth-skinned with a pattern of red, yellow, and green lines, a dark patch on the hump behind the head, and dark spots along each side. Large larvae are initially brown with three thin pale yellow lines down the back: one in the middle and one on each side. They have a row of black dots along each side, and a row of conspicuous dark half-moons along the back.

Final instar larvae are darker and can exceed 50 mm in length. All larvae have 4 pairs of ventral prolegs, and are more solid than helioverpa with fewer body hairs.

May be confused with: Small to medium larvae (10 mm) may be confused with helioverpa larvae, but differ by the 'hump' behind the head, and the row of dark spots along each side.

Host range: Adzukis, mungbeans, navy beans, peanuts, pigeon pea and soybeans.

Life cycle: Egg masses are laid on leaves. Young larvae feed on leaves but older larvae may feed on flowers and pods. Larvae pass through 6 larval stages and take 2-3 weeks to develop, depending on temperature. Larvae pupate in the soil.

Risk period and damage: Crops are most at risk at flowering and podding. Small larvae window leaves, but older larvae chew holes in leaves. Older larvae also attack flowers and pods.

Monitoring and control: As for helioverpa. Look also for egg masses and clusters of young larvae. In pre-flowering crops, control is warranted if defoliation exceeds (or is likely to) 33%. Tolerable defoliation drops to 15-20% once flowering and podding commences. NPV does not control cluster caterpillars and they can't be controlled with Bt unless they are very small.

Natural enemies: As for helioverpa and loopers.¹¹

¹¹ Australian Oilseeds Federation (2013), Better Soybeans manual http://www.australianoilseeds.com/soy_australia/Soybean_Production

7.2.2 Bean podborer *Maruca vitrata* (previously *Maruca testulalis*)



Figure 15: Large larvae (16 mm). (Photo: Australian Oilseeds Federation)

Distribution: A cosmopolitan tropical pest found that is most abundant in tropical and subtropical Australia.

Pest status and damage: Usually not a pest in soybeans, but tunnelling in stems has been reported in soybeans in coastal Qld.

Identification: Bean podborer moths have a 20-25 mm wingspan and a slender body. They have brown forewings with a white band extending two-thirds down the wing from the leading edge. Inside this band near the leading edge is a white spot. The hindwings are predominantly a translucent white with an irregular brown border. When at rest, they adopt a characteristic pose with outspread wings and the front of the body raised up. Larvae are pale cream with two rows of distinctive paired black markings on their back.

Host range: Favoured hosts include adzukis, mungbeans, cowpeas, pigeon peas but not soybeans.

Life cycle and damage: In favoured hosts, larvae feed initially in buds and flowers before moving to the pods. Soybeans are not a favoured host and the only reported damage to date has been tunnelling in the stems of coastal soybeans. After completing their development (10-15 days from egg hatch), larvae exit pods and pupate in the soil.

Monitoring and control: Look for tunnelling and associated larval frass in soybean stems. No thresholds are set as this pest is not regarded as a problem in soybeans.¹²

Altacor® (chlorantraniliprole) is very effective against podborers, killing larvae hidden inside the buds. However larval death is not immediate. While feeding stops very quickly, larvae remain moribund for 3-4 days (shrunken and darkened), before dying. This moribund state is also observed in heliothis and other caterpillars.

The key to successful control is to monitor the crops closely from early budding and target larvae before they move from the flowers to the pods. Cultural controls include getting rid of legume weed hosts such as sesbania. Other favoured hosts include pigeonpea and adzukis.¹³

¹² Australian Oilseeds Federation (2013), Better Soybeans manual http://www.australianoilseeds.com/soy-australia/Soybean_Production

¹³ H Brier, M Miles (2015), Emerging insect threats in northern grain crops: <https://www.grdc.com.au/Research-and-Development/GRDC-Update-Papers/2015/07/Emerging-insect-threats-in-northern-grain-crops>

7.2.3 Etiella (lucerne seed web moth), *Etiella behrii*



Figure 16: *Etiella* (12 mm). (Photo: Australian Oilseeds Federation)



Figure 17: Large (10 mm) larvae in a very small peanut pod. (Photo: Australian Oilseeds Federation)



Figure 18: *Etiella*-damaged soybean pod. (Photo: Australian Oilseeds Federation)

Distribution: *Etiella* is found throughout Australia. *Etiella* larvae were found in significant numbers (up to 10 larvae per square metre) in vegetative soybean crops on Queensland's Darling Downs in 2013, and in low numbers (<1/sqm) in a DAFF soybean trial at nearby Kingaroy.¹⁴

Pest status: *Etiella* is an important pest of peanuts and lentils. In soybeans, it is mostly a problem in natto beans (Japanese fermented soybeans).

Host range: *Etiella* infest many pulses including peanuts, mungbeans, adzukis, lima beans lentils and soybeans. Rattle pods are favourite weed hosts.

Identification: Moths are small (12 mm long at rest, 20-22 mm wingspan) and uniquely coloured. They are grey brown in colour with a distinctive white stripe along the leading edge of each forewing, and an orange band across each forewing. Their wings fold back along the body when resting. Moths have a prominent 'snout'.

The eggs are small (0.6 mm diameter), cream and flattened. Small larvae are cream or pale green, lack stripes, and have a dark head. Mid-sized larvae are pale green or

¹⁴ The Beatsheet, *Etiella* outbreak in vegetative soybeans on the Darling Downs: <http://thebeatsheet.com.au/crops/pulses/soybeans/etiella-outbreak-in-vegetative-soybeans-on-the-darling-downs/>

cream, with pale brown or reddish stripes. Larger larvae are characteristically green with pink or reddish stripes and a brown head. Larvae in the pre-pupal stage can be aqua blue or dark pink with no stripes.

May be confused with: Non-pest *Etiella* spp. which feed on rattle pods.

Life cycle: Eggs are laid on pods and flowers and are very hard to detect. Newly-hatched larvae bore into pods leaving a near-invisible entry hole. The lifecycle can be completed in 4 weeks at 30°C.

Risk period and damage: *Etiella* is a spasmodic but important pest of specialist soybeans in drier regions (e.g. natto soybeans on the Darling Downs) due to near zero damage tolerance. Crops may be infested from flowering onwards, but are at greatest risk during late podding. *Etiella* larvae consume far less than larger caterpillar species such as *helioverpa*, so seeds are usually only partially eaten out, often with characteristic pin-hole damage. This damage is difficult to grade out and its unattractive appearance reduces seed quality.

Etiella normally attack pods, but in 2013 and 2014, larvae caused significant damage to the auxiliary buds (precursors of the floral buds) and stems of vegetative soybeans in southern Qld and northern NSW. Similar but not as widespread stem damage was reported in mungbeans. In some South Burnett soybean crops in 2014, *etiella* activity continued well into late podfill, populations peaking at >40 larvae/m².

A study of *etiella* damage in a late podfill crop of South Burnett soybeans found the majority of larvae fed on only one seed, consuming the seed totally, and confining their activity to one seed cavity. This means there is very little impact on seed quality as the seed remnants are lost at harvest. In soybeans, one seed totally eaten equates to 2 kg/ha per larva/m². In contrast, the yield loss per *helioverpa* /m² is 40 kg/ha.¹⁵

Monitoring and control: More emphasis needs to be put on early detection of infestations. In vegetative crops, the early warning signs are damaged and dying auxiliary buds, as well as increasing moth activity.

In heavily infested mungbeans on the Darling Downs, *etiella* moths were extremely difficult to catch in sweep nets, making it difficult to estimate moth density. The alternative would be to use traps, be they pheromone, bait or light traps. Further development is required to refine the design/use of these to make them more user-friendly.¹⁶

¹⁵ H Brier, M Miles (2015), Emerging insect threats in northern grain crops: <https://www.grdc.com.au/Research-and-Development/GRDC-Update-Papers/2015/07/Emerging-insect-threats-in-northern-grain-crops>

¹⁶ H Brier, M Miles (2015), Emerging insect threats in northern grain crops: <https://www.grdc.com.au/Research-and-Development/GRDC-Update-Papers/2015/07/Emerging-insect-threats-in-northern-grain-crops>

7.2.4 Large mystery planthopper *Oteana lubra* (Cixiidae)



Figure 19: *Oteana lubra* (Cixiidae)

Very high numbers of a large planthopper (*Oteana lubra*) (no common name and formerly *Oliarus lubra*) were reported in the 2014-2015 summer in mungbeans on the Darling Downs and in North West NSW. The bulky hoppers are 9-10 mm long and pale brown/grey with a fluffy white rear end (Figure 19). They have been observed in previous years in low numbers (usually <math><1/m^2</math>) in mungbeans and soybeans, however in 2014-2015 populations in excess of 100 per 20 sweep net sweeps were observed in some crops. This most likely equates to an absolute population in excess of 20/m². All hoppers sampled were adults (i.e. there were no nymphs). This is because the nymphs of this planthopper group are root feeders, often of grasses.

Damaged pods suggest the planthoppers are not as damaging as first feared. Close examination of mungbean pods from heavily-infested crops revealed numerous feeding stings on the external pod wall, but extremely few stings on the seeds, or on the inside pod wall.

7.2.5 Loopers

Green loopers

Soybean looper *Thysanoplusia orichalcea*

Tobacco looper *Chrysodeixis argentifera*

Vegetable looper *Chrysodeixis eriosoma*



Figure 20: Soybean looper (40 mm). (Photo: Australian Oilseeds Federation)



Figure 21: Soybean looper moth (40 mm wingspan). (Photo: Australian Oilseeds Federation)



Figure 22: Tobacco looper. (Photo: Australian Oilseeds Federation)

Distribution: Green loopers occur in all soybean growing regions.

Identification green loopers: The soybean looper moth has distinctive brown forewings with a large bright golden patch. The tobacco and vegetable looper moths have dark brown forewings with small silver 'figure eight' markings. All species have a 40 mm wingspan. Looper eggs are a pale yellow green and are flatter than *helicoverpa* eggs. Larvae move with a distinctive looping action and have only two pairs of ventral prolegs. Green loopers taper noticeably towards the head. Larvae are mostly green with white stripes though colours can vary. Soybean loopers are more prominently striped, particularly when medium sized, when they often have dark stripes and can be confused with *helicoverpa* larvae. Larvae can reach 45 mm in length. Unlike *helicoverpa* which pupate in the soil, loopers usually pupate on the plant under leaves in a thin silken cocoon. Pupae are dark on top and pale underneath.¹⁷

¹⁷ Australian Oilseeds Federation (2013), Better Soybeans manual http://www.australianoilseeds.com/soy_australia/Soybean_Production

Brown loopers

Bean looper or Mocis	<i>Mocis alterna</i>
Sugar cane looper	<i>Mocis frugalis</i>
Three barred moth	<i>Mocis trifasciata</i>
(no common name)	<i>Pantylia</i> sp.



Figure 23: Bean looper (26 mm) (left), bean looper moth (32 mm) (right). (Photo: Australian Oilseeds Federation)



Figure 24: Larvae of *Pantylia* sp. moth (30 mm). (Photo: Australian Oilseeds Federation)



Figure 25: Three barred moth (45 mm wingspan). (Photo: Australian Oilseeds Federation)

Distribution: *Mocis* sp. loopers occur in Africa, Asia and Australia. The bean looper is native to Australia. Brown loopers are most common in tropical and subtropical coastal soybean growing regions.

Identification: Moths have 30-50 mm wingspans, *Mocis trifasciata* being the largest species. Sugar cane looper moths are brown and have a diagonal dark line with a pale inner edge across each forewing. The other loopers are grey or brown with dark bands and markings on all wings. Eggs are globular and pale green and are larger than helioverpa eggs.

Larvae vary in colour and can be cream, charcoal, bright orange or brown. The bean looper varies most in colour and larvae may have dark stripes along their back and often have a cream or yellow band along each side. Larvae can reach 40-50 mm in length with *Mocis trifasciata* the largest species. Larvae have 2-3 pairs of ventral prolegs, move with a looping action, and are more slender than helioverpa, particularly in the younger

stages. A distinctive feature of Mociis larvae is their forward sloping and striped heads. Larvae pupate inside curled leaves.

The following applies equally to green and brown loopers:

Pest status: Mostly minor pests feeding mainly on leaves. However high looper populations can inflict economically-damaging levels of defoliation.

Risk period and damage: Loopers can attack crops at any stage but are greatest risk during flowering and podding. Soybeans are least tolerant of defoliation at these stages. Looper leaf damage is different to helioverpa damage, the feeding holes being more angular rather than rounded. Loopers rarely attack soybean flowers and pods.

Monitoring and thresholds: Use a beat sheet to check crops twice weekly during the vegetative, flowering and podding stage until crops are no longer susceptible to attack. In pre-flowering crops, looper control is warranted if defoliation exceeds (or is likely to) 33%. Tolerable defoliation drops to 15-20% once flowering and podding commences.

Control: Products containing helioverpa NPV do not control loopers. However, Bt (e.g. Dipel) will control even medium loopers (15-20 mm long). For chemical control options refer to the APVMA website.

Natural enemies: Loopers are frequently parasitised by braconids (*Apanteles sp.*) with scores of parasite larva developing per looper host. Predatory bugs, tachinid flies, and ichneumonid wasps also attack loopers. The use of Bt (Dipel) will help preserve beneficial insects. Outbreaks of looper NPV are frequently observed in crops with high looper populations. However, larvae are usually not killed by virus until they are medium-large (instars 4-5). Looper NPV is not the same as helioverpa NPV and the latter has no impact on loopers.¹⁸

7.2.6 Common grass blue (butterfly) *Zizina labradus* Lepidoptera: Lycaenidae

Also known as grass blue and lucerne blue.



Figure 26: Egg (1 mm diameter). (Photo: Australian Oilseeds Federation)

¹⁸ Australian Oilseeds Federation (2013), Better Soybeans manual http://www.australianoilseeds.com/soy-australia/Soybean_Production



Figure 27: Male (top) and female common grass blue butterflies. (Photo: Australian Oilseeds Federation)



Figure 28: Larvae (10 mm) and windowing damage. (Photo: Australian Oilseeds Federation)



Figure 29: Hoverfly larvae (10 mm), a key aphid predator. (Photo: Australian Oilseeds Federation)

Distribution: Native to and spread throughout Australia including Tasmania.

Pest status: Mostly minor but frequently causes significant damage to soybeans in inland NSW and Qld.

Identification: The adult's wings are pale dull blue on top with dark grey edgings (wider in the females). They lack tails and eye spots. The undersides of the wings are brown with soft markings. The eggs are relatively large (1 mm diameter) are bluish and flattened with a central depression, and are laid singly. The small green slug-like larvae reach only 10 mm in length. Larvae are pale green with a central pale stripe and often with pale patterning on their back. Their head is difficult to see as it is usually tucked out of sight.

May be confused with: Larvae are sometimes confused with hoverfly (*Diptera: Syrphidae*) larvae, which are also 'slug like', are of similar size, and may be similarly coloured and patterned. Both may also be found on leaf terminals. However, hoverfly larvae are more tapered towards the head, often wave the front of their body from side

to side, and are aphid predators. Other lycaenid larvae are also similar in outline and colour, particularly those of the bean flower caterpillar *Jamides phaseli*. The adults can be distinguished from other lycaenids such as the pea blue, *Lampides boeticus*, by their lack of eyespots and tails.

Host range: Feed on most pulse legumes but most common in soybeans. They also feed on lucerne.

Life cycle: Eggs are laid singly on leaves. Larvae mostly feed on leaves. Larvae pupate in loose webbing under leaves.

Risk period: Can attack at any stage. Less vigorous drought stressed plants are at greatest risk as terminals are more likely to be attacked.

Damage: Larvae feed mostly on leaves and terminals, but occasionally feed on flowers. Damaged leaves may be windowed. Excessive terminal loss results in pods being set too close to the ground, which makes harvesting difficult.

Monitoring: Check crops with a beat sheet, look for larvae inside terminals, and for large numbers of the distinctive (and pretty) blue butterflies.

Action level: Control if terminal loss exceeds 25%.

Control: Most products targeting helioverpa (except *Helicoverpa virus*) will also control this pest.¹⁹

7.2.7 Leaf miners and webbers

Soybean moth Aproaerema simplexella (previously *Stomopteryx simplexella*)

Pest Status: Mostly minor. Soybean moth is common in soybeans but is usually only present in low numbers with only the occasional leaf slightly webbed and folded to provide a shelter for larvae. However, they spasmodically occur in very high numbers inflicting significant leaf damage, and on rare occasions can destroy crops by denuding all the leaves.

Identification: Moths are small (6 mm long) with narrow dark wings with a transverse white band. Caterpillars are small (up to 7 mm long) and are grey green with a dark head. Larvae are usually found feeding inside the leaves (i.e. in leaf mines, which are straw coloured). The small eggs are often laid on leaf veins.

Damage and control: Soybean moth larvae initially feed inside mine leaves and sometimes emerge to feed externally, folding and webbing leaves together. Larvae normally only cause cosmetic damage but heavy infestations can make multiple leaf mines per leaf resulting in leaf death.

Infestations are favoured by hot, dry weather, with crops under severe moisture stress most at risk. Crops near trees are often more severely infested.

Monitoring: Scout crops regularly for the early warning signs of rare plague events - numerous small, pale patches (leaf-mining) on the leaves and large numbers of soybean moths around lights at night. Indicative threshold is based on defoliation (i.e. 33% pre flowering and 15-20% during early podfill).

Control: Control will rarely be required and no specific registrations exist for soybean moth. Abamectin (registered in soybeans against mites) gave good control of this pest at the mite rate (300 mL/ha) in recent DAFF trials.²⁰

¹⁹ Australian Oilseeds Federation (2013), Better Soybeans manual http://www.australianoilseeds.com/soy_australia/Soybean_Production

²⁰ Australian Oilseeds Federation (2013), Better Soybeans manual http://www.australianoilseeds.com/soy_australia/Soybean_Production



Figure 30: Soybean moth (6 mm). (Photo: Australian Oilseeds Federation)



Figure 31: Soybean moth larvae (7 mm). (Photo: Australian Oilseeds Federation)



Figure 32: Severe leaf damage. Note numerous leaf mines. (Photo: Australian Oilseeds Federation)



Figure 33: Typical light folded-leaf damage, (Photo: Australian Oilseeds Federation)

Legume webspinner or bean leafroller Omiodes diemenalis
 (previously *Lamprosema abstitalis*)

Pest status: Minor. Widespread in coastal regions but rarely at damaging levels.

Identification: The distinctive moths are brown with bright yellow patches and an 18 mm wingspan. Larvae roll and web leaves together, and are considerably larger than larvae of the soybean moth. Young larvae are pale green with dark heads. Older larvae are shiny green with pale brown/orange heads and reach 15 mm in length.

May be confused with the soybean moth and bean podborer larvae.

Host range: Soybeans, mungbeans, adzukis and navy beans.

Risk period and damage: Legume webspinners are widespread in coastal regions but rarely at damaging levels. Crops are usually at greatest risk during early podding. The larvae are leaf feeders, webbing leaves together. Silken webs and frass are indicative of webspinner attack, but other leaf webbers cause similar symptoms.

Monitoring and control: Larvae will be sometimes detected when beat sheet sampling. Also inspect webbed leaves and look for the characteristic frass. The threshold is based on tolerable defoliation (i.e. 33% pre flowering and 15-20% during early podfill). Control is rarely required.²¹



Figure 34: Legume webspinner (18 mm wingspan). (Photo: Australian Oilseeds Federation)



Figure 35: Larvae (14 mm), note pale. (Photo: Australian Oilseeds Federation)



Figure 36: Large (7 mm) larvae and typical frass (pooh).

²¹ Australian Oilseeds Federation (2013), Better Soybeans manual http://www.australianoilseeds.com/soy_australia/Soybean_Production

7.2.8 Beetle pests

Monolepta or redshouldered leaf beetle or *Monolepta australis*



Figure 37: *Monolepta* beetles and damage. (Photo: Australian Oilseeds Federation)

Distribution: Throughout northern Australia. Particularly abundant in coastal cane-growing regions where larvae feed on sugarcane roots.

Pest status: *Monolepta* can arrive suddenly in large numbers, inflicting rapid defoliation and flower loss.

Identification: Beetles are 6 mm long and are yellow with a distinctive dark red (purple) band across the shoulders and two red/purple spots on the ends of the wing covers. The flaccid, yellowish eggs are small (< 1 mm across) and oval. Larvae are white, 5 mm in length, slightly flattened with hard brown plates at both end.

Host range: Adults feed on a broad range of plants including soybeans, navy beans, mungbeans and peanuts. Other hosts include avocado, cotton, lychee, macadamia, mango, strawberry, and numerous ornamentals. Larvae feed underground on roots of sugarcane and pasture grasses.

Life cycle: Eggs are laid in the soil surface, mainly in pastures and sugar cane. Larvae feed on the grass roots and pupate in the soil. The life cycle takes about 2 months in summer and there are 3-4 generations annually. Adults usually emerge from the soil after heavy rains following a dry spell. If larval populations in the soil are high, the multitude of emerging beetles will form an aggregation and swarms may migrate into nearby soybean crops.

Risk period and damage: *Monolepta* are common in sugar cane areas. They can arrive suddenly in large numbers, inflicting rapid defoliation and fewer losses. Soybeans are at greatest risk during flowering. Infestations are most likely after heavy rainfall events. *Monolepta* attack leaves and flowers with very high populations (e.g. > 50/m²) shredding leaves and denuding crops of flowers.

Monitoring and thresholds: *Monolepta* are readily assessed visually or with a beat sheet but can be difficult to count as they are extremely flighty. Estimate the number of groups of 5 or 10 beetles on the sheet to get a 'ball park' population estimate. Check crops after heavy rainfall that may trigger the mass emergence of adults. Thresholds are not yet established but populations greater than 20/m² can cause significant damage in flowering crops. Defoliation thresholds are the same as for leaf feeding caterpillars.

Control: *Monolepta* beetles are readily controlled with Steward® (indoxacarb) at 200mL/ha. Spot treatment of borders close to cane may be sufficient. If possible, plant soybeans away from key *Monolepta* hosts such as sugar cane.²²

²² Australian Oilseeds Federation (2013), Better Soybeans manual http://www.australianoilseeds.com/soy_australia/Soybean_Production

Lucerne crown borer or zygrita *Zygrita diva*

Lucerne crown borer is often a problem where soybeans are grown in close proximity to lucerne, and in edamame beans.

The pest has been on the increase in recent years, with reports of up to 90% of plants infested and early plant deaths in some crops. Areas infested ranged from coastal Qld to Central NSW, and included the Darling Downs. Damage was worse in early planted (Oct/Nov) crops. In some crops, larvae girdled plants prior to pupation as early as February when crops were only at the pod set stage. The resultant plant deaths severely reduced yield. This premature pupation was triggered by prolonged high temperatures and low rainfall, both of which lead to crop stress which is a major trigger for early pupation in crown borer.²³

Identification: Adults are 15 mm long and bright orange with black legs and long black antennae. They usually have two prominent black spots on their wing covers, but these may be absent or more spots can be present. The similar shaped, mottled brown *Corrhenes stigmatica* (also a stem borer) is less common. Larvae of this species are cream with a wide head and are up to 25 mm in length.

Host range and life cycle: This pest can be found in soybeans and lucerne as well as in phasey bean and sesbania. Infestations occur when eggs are inserted in the stems of young soybeans, usually from flowering onwards. Larvae tunnel up and down through the pith in the stem, but usually pupate in the tap root.

Risk factors and damage: Soybean crops in the tropics, or growing in abnormally 'hot' summers, or in close proximity to lucerne are at greatest risk from crown borer. Proximity to lucerne increases the risk of early infestation. Larval feeding has little impact on yield but prior to pupating, plants are internally ringbarked or girdled above the pupal chamber causing plant death above the girdle and plants in thin stands may lodge before harvest. In southern Queensland, this usually occurs after seeds are fully developed (physiological maturity) with no yield loss. In tropical regions, larval development is more rapid and there can be considerable crop losses. Crown borers are very damaging to 'edamame' soybeans where green immature pods are harvested by mechanical pod pluckers, the weakened stems of infested plants being plucked into the harvester as well.

Monitoring and control: Break open stems to look for larvae and eaten out and brown discoloured pith. There are no effective chemical controls as larvae in the stems are protected from insecticides. Avoid planting soybeans close to lucerne and, if in an at-risk region, consider later plantings to shorten crop development. In the tropics, consider winter plantings. Also avoid thin plant stands to reduce the lodging of damaged plants. Currently there are no pesticides registered for *Zygrita* in soybeans. Trying to control the only vulnerable stage, the adults in early vegetative crops, with non-selective pesticides, would greatly increase the risk of silverleaf whitefly attack.²⁴



Figure 38: *Zygrita* larvae (12 mm). (Photo: Australian Oilseeds Federation)



Figure 39: *Zygrita* adult (15 mm). (Photo: Australian Oilseeds Federation)

²³ H Brier, M Miles (2015), Emerging insect threats in northern grain crops: <https://www.grdc.com.au/Research-and-Development/GRDC-Update-Papers/2015/07/Emerging-insect-threats-in-northern-grain-crops>

²⁴ Australian Oilseeds Federation (2013), Better Soybeans manual http://www.australianoilseeds.com/soy-australia/Soybean_Production

Soybean aphid *Aphis glycines*

This exotic pest was detected in Australian soybeans during the 1999-2000 season. It is more prevalent on the coast than in inland crops and more abundant in cooler summers.

Identification: The soybean aphid is small (to 2 mm long) and has a very bright, translucent green body. This aphid also has black siphunculi and a pale cauda.* No other aphid on soybeans has the same size and colour combination.

Damage: Aphids are normally not a major threat to soybeans but populations should be monitored. In the unusually cool summer of 2007/08 severe aphid outbreaks occurred in the Bundaberg region. Aphids are more prevalent on the coast than inland. Cast off (white) aphid skins are evidence of past infestations. Heavily infested plants may be covered in sooty mould growing on honeydew secreted by the aphids. Such infestations can reduce yield significantly and delay harvest maturity. Infested plants can have distorted leaves. Crops become less attractive to aphids after early podding. The adult, winged-form of the aphid, is able to travel long distances on prevailing wind currents.

Monitoring: Look for aphid colonies on the upper stems, leaflets and terminal leaves. In heavily infested crops, cast off aphid skins, sooty mould and large ladybird populations are indicative of soybean aphids. However the latter two can also indicate significant whitefly activity.

Chemical control is rarely required in most seasons due to the significant impact of natural enemies, especially ladybirds and hoverfly larvae. While, soybean aphids can be controlled with systemic pesticides, no products are specifically registered for this pest in Australian soybeans. In the USA, the soybean aphid threshold is set at 250 aphids per plant from budding to podding. As a rule of thumb, once soybean aphids are present on the main stem, populations are in excess of 400 aphids per plant. During the vegetative stage, avoid 'hard' pesticides against other pests, as these pesticides may kill ladybirds and 'flare' the aphids.²⁵



Figure 40: *Siphunculi (or cornicles or honey tubes) are a pair of upward and backwardly pointing tubes on the top of an aphid's back/abdomen. The cauda is a 'tail-like' structure, usually present below and between the siphunculi on the last abdominal segment. (Photo: Australian Oilseeds Federation)

²⁵ Australian Oilseeds Federation (2013), Better Soybeans manual http://www.australianoilseeds.com/soy_australia/Soybean_Production

7.2.9 Mirids

Hemiptera: Miridae

Green Mirid *Creontiades dilutus*

Brown Mirid *Creontiades pacificus*

Distribution: The green mirid is widespread and endemic to Australia but the brown mirid also extends into Asia.

Pest status: Mirids are only a minor to moderate pest of soybeans. This contrasts with their major pest status in mungbeans.

Identification: Mirid adults are 6-7 mm long with elongated bodies, long legs (especially the hind legs) and long antennae. Green mirid adults are pale green and sometimes have reddish flecking on their legs. Adult brown mirids have two distinct colour forms. The brown form is predominantly light brown with darker pigmentation on their hind legs, and the green form is mostly bright green with dark red (purple-brown) pigmentation of the head, hindlegs and parts of the thorax.

Mirid nymphs are smaller, elliptical-shaped and lack wings. Young nymphs have antennae much longer than their body. First instar nymphs are pale brown/orange but later instars are pale green. Green mirid nymphs have pale antennae while brown mirid nymphs have distinctive reddish (brown) antennae with white banding.

Hosts: Mirids attack a wide range of summer legumes including adzukis, mungbean, navy bean, peanuts, pigeon pea, and soybeans. Other hosts include cotton, horticultural crops and lucerne.

Life cycle: Mirids may be present at any stage from seedlings to podding. Populations are often low during the vegetative phase, but increase rapidly after budding. Over 80% of mirids in flowering legumes may be nymphs and populations in excess of 10 per m² are not uncommon. Populations frequently decline once flowering ceases. Pale, elongated eggs are laid singly into plant tissue with a small area of the egg exposed. There are usually 5 nymphal stages. Mirid development from egg to adult is very rapid at high temperatures and takes only 16 days at 30°C. Egg development is relatively slow, and makes up 37% of total development time.

Risk period: Soybeans are potentially at greatest risk during budding, flowering and early-podding. However, soybeans are at far less risk of economic damage than susceptible hosts such as mungbeans. Low mirid populations are often present in vegetative soybeans but there is no evidence they cause 'tipping' of vegetative terminals as occurs in cotton. Influxes of mirid adults often follow north-west winds in spring.

Damage: Mirids attack buds, flowers and small pods. However soybeans are less susceptible to mirids than mungbeans. Mirid populations of up to 5/m² had no impact on soybean yield in recent DAFF trials. For this reason, mirid thresholds in soybeans are far higher than in mungbeans.

Monitoring: Mirids are very mobile pests and in-crop populations can increase rapidly. Crops should be inspected twice weekly from budding onwards until post flowering. The preferred monitoring method is the beat sheet. Sample 5 one-metre lengths of row (not consecutive) within a 20 m radius, from at least 6 sites throughout a crop. Avoid sampling during very windy weather as mirids are easily blown off the beat sheet.

Thresholds: The mirid thresholds for soybeans is 5-6 mirids per m².

Chemical control: Dimethoate at 500 mL/ha (all summer pulses) or indoxacarb at 400 mL/ha (soybeans and mungbeans only). Dimethoate is often applied at lower than label rates (e.g. 200-250 mL/ha). These rates give excellent mirid control but have far less impact on most beneficials. The addition of salt (0.5% NaCl) as an adjuvant, maintains the performance of dimethoate at lower rates. The rate of salt used (0.5%) has no phytotoxic effect on soybeans.

'Hard' water can markedly lower the effectiveness of dimethoate and should be countered by adding a buffering agent such as Li700. Indoxacarb is not recommended for mirids in soybeans because its label warns against using it against mirid populations $>2/m^2$ which is far lower than the threshold.²⁶



Figure 41: Green mirid adult (7 mm).
(Photo: Australian Oilseeds Federation)



Figure 42: Brown mirid nymph (3 mm). (Photo: Australian Oilseeds Federation)

7.2.10 Two-spotted or red spider mite *Tetranychus sp.*

Pest status: Two spotted or red spider mites (the same species) can cause severe damage, particularly during hot, dry weather, but are not a problem in most crops. Mite outbreaks are often the result of 'hard' pesticide sprays (targeting other pests) which kill the mites' natural enemies.

Identification: Adult mites are 0.5 mm long, have 8 legs, and in summer are usually yellow-green with a large dark green spots on each side of the body. The overwintering form is red with dark spots. Nymphs are similar but smaller in size.

Feeding behaviour and damage: Mites initially invade the lower leaves and gradually move to the top of the plant as populations build up. They make fine webbing on the underside of the leaves, and feed by a rasping and sucking action. Infested leaves take on a speckled appearance. In severe cases, the damaged leaves turn yellow-brown before they wither and drop from the plant.

Heavy infestations during flowering and early pod formation result in early leaf senescence and may significantly reduce seed size and yield. Heavy mite infestations during pod-fill hastens leaf drop and brings on early senescence. Yield loss from mites can be as high as 30%, with the late maturing, longer season varieties most at risk.

Control: Abamectin currently gives effective control. The threshold is 30% leaves infested. While still registered, dimethoate no longer provides effective control as mites are now resistant to older miticides. As mites have the potential to also develop abamectin resistance, every effort should be made to avoid flaring mites with non-selective insecticides.²⁷



Figure 43: Red overwintering form of the two spotted mite. The summer form is green with two dark spots. (Photo: Australian Oilseeds Federation)

²⁶ Australian Oilseeds Federation (2013), Better Soybeans manual http://www.australianoilseeds.com/soy_australia/Soybean_Production

²⁷ Australian Oilseeds Federation (2013), Better Soybeans manual http://www.australianoilseeds.com/soy_australia/Soybean_Production

7.2.11 Field Crickets

Black field cricket *Teleogryllus commodus*

Brown or inland field cricket *Lepidogryllus parvulus*

Pest status: Spasmodic pests capable of inflicting serious pod damage that looks like mouse damage.

Identification: Both are typically cricket shaped, with long powerful jumping hind legs, large jaws and long antennae. The black field cricket is larger (30 mm) and darker than the brown field cricket.

Behaviour and damage: Field crickets shelter in cracks in the soil and can cause serious losses in soybeans, particularly in areas with heavy cracking soils. Field crickets often attack seedlings but late summer infestations chew holes in pods to eat the developing seeds. Plagues are most common when mild winters are followed by warm, dry summers.

Monitoring: Check crops for crickets at dusk or at night when they are most active. Cricket activity can also be monitored with light traps. Alternatively, place hessian bags overnight at regular intervals across the paddock. In the morning check for crickets sheltering under the bags.

The best way to determine whether mice (and not crickets) are the culprits is to also check crops at night or to use mouse bait cards. If little mounds of damaged pods are found on the ground throughout the crop, then mice are most likely the culprits, as this is classic rodent food-hoarding behaviour.

Control: Grain baits are recommended for in-crop control of crickets. Use a mix of 4L Lorsban® (50% a.i.) with 5L sunflower oil and 100 kg cracked wheat. Combine the Lorsban and oil before adding the grain then let the mix 'set' for 6-8 hours before spreading 2.5 kg of the bait mix per hectare. Use sorghum if cracked wheat is not available. Ideally the grain should be cracked into small pieces, but not ground to fines. Some aerial applicators will supply a similar bait mix. Note that control with baits is difficult in soybean crops with dense canopies.²⁸



Figure 44: Black field cricket (30 mm) (left), cricket damage to pods (right). (Photo: Australian Oilseeds Federation)

²⁸ Australian Oilseeds Federation (2013), Better Soybeans manual http://www.australianoilseeds.com/soy_australia/Soybean_Production

7.2.12 Black field earwig *Nala lividipes*

Pest status and identification: Periodically cause serious damage to seedling crops. Black field earwig are most prevalent in areas with cracking soils. They are elongated, 15 mm long, with short wing covers and large pincers at their rear. Do not confuse BFE with the much larger (20 mm) light brown predatory earwig.

Damage and control: These soil-dwelling insects feed on the germinating shoots, and on recently emerged seedlings which they ringbark at ground level. In-crop treatments with chlorpyrifos grain baits can provide a degree of control.²⁹



Figure 45: Black field earwig (14 mm). (Photo: Australian Oilseeds Federation)

7.2.13 Slugs

Pest status: Increasing in zero till crops in wetter seasons. The wet spring early summer conditions of 2010/11 have favoured the return of a pest not seen for many years – slugs! Damaging slug populations, reported in seedling crops in northern NSW and southern Queensland, have totally destroyed some crops. Later slug infestations have attacked soybean pods.

Risk factors: Increased zero/minimum till and stubble retention practices which favour slug and snail development and survival. Increased organic matter provides an increased food source, especially to young slugs (and snails). Other high slug risk factors include prolonged wet weather, trash blankets, weedy fallows and a previous slug history. Slugs are best controlled before the crop is planted.

Monitoring: Determine the slug risk in your paddocks prior to planting. Monitor regularly so slug numbers can be detected early prior to planting, as there are more control options at this time. To estimate slug numbers, place wet carpet squares, hessian sacks or tiles on the soil surface. They should at least be 32cm x 32cm (10% of a square metre). Place slug pellets under them and check after a few days. Count the number of slugs under and around each square. Multiply the numbers by 10 to get an estimate of slugs per square metre.

Thresholds: If an average of more than one (1) slug per trap is found, the slug problem is significant. If more than eight (8) slugs are found per trap the problem is severe.

²⁹ Australian Oilseeds Federation (2013), Better Soybeans manual http://www.australianoilseeds.com/soy_australia/Soybean_Production

Timing of control: Slugs are best controlled before the crop is planted. Ideally, fallows should be bare so the only food source for slug is the baits. For this reason, baits applied post-emergence are less effective than pre-emergent baits, as slugs often prefer the emerging seedlings.

Chemical control: Take action if there is significant slug activity in the pre-crop fallow, 2 weeks before planting. Two equally effective bait types are registered for slug control in field crops, those based on metaldehyde (e.g. SlugOut) and those based on an iron chelates (EDTA complex), (e.g. Multiguard).

Metaldehyde based baits are highly toxic to mammals and birds (Schedule 5 poisons) and must be spread evenly to avoid heaping which attracts non target animals. Metaldehyde based products are registered in pulses for use prior to and up to the 4 leaf stage.

Iron chelate based baits are specific to slugs and snails (molluscs) and slaters (crustaceans) and have low toxicity to mammals and birds (no poison schedule). They have no impact on carab beetles which are key snail predators and hence are the preferred IPM option. Iron chelate based compounds are registered for use in the bare fallow prior to planting, and also in crop boundaries.

Protecting animals and birds: While of low toxicity, iron chelate baits are attractive to some animals and birds. The bait's mild alkalinity may cause certain animals to vomit, especially dogs. For this reason, spread the bait evenly to avoid heaping which might attract dogs and birds.

Insecticides sprays for other soil pests: Sprays targeting armyworms and cutworms are ineffective against slugs. Where there is extreme slug pressure, baits alone will not bring slugs under control.

Cultural control: Cultural practices which discourage slugs and snails include cultivation (2 shallow discings) to bury trash and levelling the seedbed with a roller to crush clods. Don't use press wheels as these create a humid furrow in the soil. These strategies are at odds with zero/minimum till and stubble retention practices aiming to conserve soil moisture. However, cultural practices to reduce high slug numbers may have to be employed periodically, as chemical control alone is unlikely to eliminate slugs in farming systems that retain stubble blankets.

Slug identification: To help build up a national slug incidence data base, and to determine which species are causing problems in NE Australia, please collect and forward slugs to Australian slug expert Michael Nash at CESAR, Bio21 Institute, Melbourne University, 30 Flemington Rd., Parkville, Victoria 3010. Ph 0383 442 521. Mob 0417 992 097 manash@unimelb.edu.au . Post/courier slugs in a jar with moist paper and record the location (including GPS coordinates). Also record the soil type, paddock history (e.g. zero or minimal till or regular cultivation) and the paddock's cropping history.³⁰



Figure 46: Slug (25 mm). (Photo: Australian Oilseeds Federation)

³⁰ Australian Oilseeds Federation (2013), Better Soybeans manual http://www.australianoilseeds.com/soy-australia/Soybean_Production

7.2.14 Mouse plagues

Mouse damage to soybeans is an ongoing and costly problem in many areas such as the Darling Downs. Soybeans are especially vulnerable, as they are often the last of the summer crops to mature and as a consequence are the only food available. Crop damage from mice is often unnoticed until it is severe. Signs of mouse activity include chewed stems or damage to seed pods. Debris such as seed husks at the base of plants suggests the damage to seed pods has been caused by mice rather than insects or birds. You can also monitor mice with mouse bait cards.

Zinc phosphide grain baits are now registered for use in soybeans and other grain crops. It is an inorganic compound that rapidly breaks down in the presence of the stomach acids to release the toxic gas phosphine. Mouse death usually occurs within two hours of ingestion.

Contact BioSecurity Queensland on 13 25 23 or refer to the QDAF website for further details on the use of these baits.³¹

7.3 Thresholds for control

Economic thresholds are one of the cornerstones of Integrated Pest Management (IPM). They help to rationalise (and thus limit) the use of pesticides and are one of the keys to profitable pest management. The development of economic thresholds requires knowledge of pests, their damage, and the crop's response to damage. Economic thresholds are available for most, but not all, pests in soybeans.³²

An economic threshold (ET) is defined as: 'the pest population likely to cause damage equal in value to the cost of control (pesticide plus application)'.

Such a population can be defined as the "critical" or "break even" population. Spraying is only recommended when insect numbers exceed the ET (i.e. when the value of damage is likely to exceed the cost of control). This classical definition applies for crop/pest scenarios where yield loss is the critical factor governing spray decisions (as opposed to situations where potential quality reduction and price discounts are the critical driving factor).

There are sound economic and biological reasons for only spraying above-threshold pest populations. Firstly, you are financially worse off if you spray below-threshold populations. Secondly, unnecessary spraying with non-selective insecticides puts crops at unnecessary risk from non-target pests, particularly heliothis and whiteflies, and can lead to yet more spraying. Finally, unnecessary spraying hastens the development of pesticide resistance in heliothis and other pests.

Thresholds are usually specified as the number of insects found per unit crop area (or length of row) using a specified (standard) sampling technique. In soybeans and other summer pulses, the recommended sampling method is the beat sheet, and thresholds are expressed in terms of pests per square metre (pests/m²). If other row-based sampling methods are used, thresholds are often expressed in terms of 'beat sheet equivalents'/m². If your row spacing is other than one (1) metre, convert your pest counts/m to pests/m² by dividing them by the row spacing in metres.³³

³¹ Australian Oilseeds Federation (2013), Better Soybeans manual http://www.australianoilseeds.com/soy-australia/Soybean_Production

³² Australian Oilseeds Federation (2013), Better Soybeans manual http://www.australianoilseeds.com/soy-australia/Soybean_Production

³³ Australian Oilseeds Federation (2013), Better Soybeans manual http://www.australianoilseeds.com/soy-australia/Soybean_Production

7.3.1 Yield-based thresholds

Table 1: Soybean yield loss thresholds by crop stage

Crop stage	Pest	Threshold	Comments
Seedling/early vegetative	Helicoverpa & grass blue butterfly	25% terminal loss	Terminal loss more likely if crops are moisture stressed
Mid-late vegetative	Helicoverpa	6/m ² +	Lower threshold in early vegetative crops or take action if terminal loss exceeds 25%
Vegetative	Spodoptera, loopers & grass blue butterfly	33% defoliation or 25% terminal loss	Terminal loss most likely if grass blue larvae present
Budding, flowering	Thrips	4-6 per flower	Open and inspect flowers
Budding, flowering & early podding	Mirids	5/m ² +	Trials show no yield loss for mirid populations up to 5/m ²
Budding to podding	Spodoptera	3/m ² +	Not as damaging as helicoverpa
	Loopers	15-20% defoliation	
	Soybean aphids	250 aphids per plant	
Budding to late pod fill	HELICOVERPA	See Table 2	Based on yield loss model below; inspect flowers and terminals for small larvae
Early to late podfill	PODSUCKING BUGS	See Table 3	Thresholds for crushing are double those for edible beans

Note:

+ Thresholds are based on beat sheet sampling and are expressed in pests/m².

* Replaces 33% defoliation threshold which still applies for other caterpillar species.

Table 2: Economic yield thresholds* for helicoverpa in podding soybeans

Control cost (\$/ha)	Helicoverpa thresholds* (larvae/m ²) at soybean crop values listed below (\$/t)									
	\$350	\$400	\$450	\$500	\$550	\$600	\$650	\$700	\$750	\$800
\$15	1.1	0.9	0.8	0.8	0.7	0.6	0.6	0.5	0.5	0.5
\$20	1.4	1.3	1.1	1.0	0.9	0.8	0.8	0.7	0.7	0.6
\$25	1.8	1.6	1.4	1.3	1.1	1.0	1.0	0.9	0.8	0.8
\$30	2.1	1.9	1.7	1.5	1.4	1.3	1.2	1.1	1.0	0.9
\$35	2.5	2.2	1.9	1.8	1.6	1.5	1.3	1.3	1.2	1.1
\$40	2.9	2.5	2.2	2.0	1.8	1.7	1.5	1.4	1.3	1.3
\$45	3.2	2.8	2.5	2.3	2.0	1.9	1.7	1.6	1.5	1.4
\$50	3.6	3.1	2.8	2.5	2.3	2.1	1.9	1.8	1.7	1.6
\$55	3.9	3.4	3.1	2.8	2.5	2.3	2.1	2.0	1.8	1.7
\$60	4.3	3.8	3.3	3.0	2.7	2.5	2.3	2.1	2.0	1.9

* Threshold based on a measured yield loss of 40 kg/ha for every larva per square metre. Cross-reference the cost of control versus the crop value to determine the economic threshold (ET), e.g. if the cost of control = \$35/ha and the crop value = \$450/t, the ET = 1.9.

Spray helicoverpa only if they exceed the threshold which is the break even point.

Table 3: Economic quality threshold* for green vegetable bug (GVBAEQ) in edible soybeans

Potential yield (t/ha)	0.5	1.0	1.5	2.0	2.5	3.0	3.5	4.0	4.5	5.0
Nato soybeans	0.1	0.2	0.3	0.4	0.5	0.6	0.7	0.8	0.9	1.0
Normal soybeans	0.1	0.1	0.2	0.3	0.3	0.4	0.4	0.5	0.6	0.6

*Threshold based on a rate of damage of approximately 80 harvestable seeds per adult bug per square metre. Spray bugs at the 2% action threshold, before the critical 3% damage level is reached. This allows for other insect damage not caused by podsucking bugs. Note that thresholds increase in 'larger' crops as more bugs are required to inflict a given percentage (%) of damage. When mixed bug populations are present (adults & nymphs) convert their damage potential to green vegetable bug adult equivalents (GVBAEQ).³⁴

³⁴ H Brier, J Wessels, K Charleson (2013) Good Bug? Bad Bug? <http://ipmworkshops.com.au/wp-content/uploads/GoodBadBug-Mar2013.pdf>

Yield-based economic thresholds (ETs) are used in situations where the value of the damage caused by an insect pest is in direct proportion to the numbers of that pest present in a crop (eg. 1 heliothis/m² causes a certain amount of yield loss, 2 heliothis/m² causes twice as much yield loss, etc). Yield based thresholds in pulses are used for mirids, helicoverpa and loopers. Where the amount of damage per pest is known (i.e. has been quantified), the ET can be calculated using the following generic equation:

$$\text{Economic Threshold (pests/m}^2\text{)} = \frac{C}{V \times D}$$

where C = cost of control including application (\$/ha)

V = crop value (\$/tonne)

D = damage per pest (t/ha for every pest/m²)

Spraying is only recommended when insect numbers exceed the ET (i.e. when the value of likely damage exceeds the cost of control). Just how far above the ET a pest population is before action is taken is a matter of individual judgement, how confident you are in your sampling, likely crop value, and the cost of control.

While the amount of damage caused per insect is relatively constant (in the models if not real life), both the value of the crop and the cost of control can vary. Therefore a true economic threshold accommodates fluctuations in pesticide prices and crop value. Thresholds can therefore vary for different pesticides. As a rule of thumb, the lower the cost of control, and the higher the crop value, the lower the threshold, and vice versa.

Below is an example of an economic threshold calculation for helicoverpa in soybeans, where the damage factor (D) at podding has been determined as being 50 kg/ha (0.05 t) for a density of one (1) larvae per square metre of crop. If a crop with an estimated value (V) of \$500/t is to be aerially sprayed with a product costing \$28/h (C = cost of pesticide plus application is ≈ \$28 + \$15 = \$43/ha), then:

$$\text{Economic Threshold (pests/m}^2\text{)} = \frac{C}{V \times D}$$

$$= 43 \div (350 \times 0.05)$$

$$= 1.7 \text{ helicoverpa larvae per m}^2$$

Where crop values and spray costs vary markedly, thresholds can be easily determined and compared by referring to threshold charts specific to the pest in question.³⁵

7.3.2 Nominal thresholds

Where the damage factor (D) is unknown, pests are assigned a nominal or fixed threshold, based on the experience and gut feelings of consultants and researchers. While some nominal thresholds are reasonably close to the mark, they fall down in situations when crop values and spray costs vary widely. An example of a nominal threshold is the set threshold of 3 cluster caterpillars/m² in podding soybeans.³⁶

7.3.3 Benefit:Cost Ratio

One commonly used rule of thumb in IPM programs is the adoption of a Benefit:Cost Ratio (BCR) of 2:1, meaning that action is only taken when the value of likely damage prevented is twice the cost of control. This rule is most feasible where the cost of control is low.

An example of this is the ground rig application of dimethoate for mirids (\$8/ha). In effect, a 2:1 BCR doubles the action threshold and by default, reduces the number of sprays applied. Most growers would presumably rather spend \$8/ha to save \$16 worth of crop loss/ha (i.e. an \$8 'profit'/ha - than spend \$8/ha to save \$8/ha - a \$0 net profit/ha).

³⁵ Australian Oilseeds Federation (2013), Better Soybeans manual http://www.australianoilseeds.com/soy_australia/Soybean_Production

³⁶ Australian Oilseeds Federation (2013), Better Soybeans manual http://www.australianoilseeds.com/soy_australia/Soybean_Production

A cost benefit of 2:1 is acceptable where the cost of control is low, but not where control costs are high. For example, if cost of control is \$60/ha, it is unlikely that an additional \$60/ha worth of damage would be accepted by most growers before they responded. In this scenario, the BCR might be reduced to 1.3 - equivalent to wearing an extra \$20/ha before treating the pest problem (i.e. spending \$60 to save \$80 worth of damage). However, exactly what BCR values are adopted is a matter for negotiation between consultants and their clients.³⁷

7.3.4 Defoliation thresholds

Defoliation thresholds are a type of yield-based threshold, but are based on studies linking % defoliation with yield loss. Studies have shown that vegetative crops are remarkably tolerant of attack, and can tolerate 33% defoliation with no subsequent loss of yield. However, tolerable defoliation falls to 15-20% during flowering/podding/podfill.

By factoring in the cost of control, higher defoliation levels could probably be tolerated. But, in practice, if leaf feeding is severe then action might be required before defoliation reaches the threshold. This is especially the case where biopesticides are employed as they are best targeted against relatively small larvae (ideally < 7 mm long) and in many cases a 50-60% kill would suffice to avoid yield loss.

Crop status will have a large bearing on decisions made in these situations. The larger the crop, the less % defoliation occurs for a given number of leaf feeding pests. Rapidly growing, healthy crops are at lesser risk. Smaller drought-stressed crops face the risk of terminal damage and are more affected by sap-sucking pests like aphids and whiteflies.

Note that for *helicoverpa* in vegetative soybeans, the 33% defoliation threshold has been replaced by a yield-based threshold of 6 larvae/m² (reduce this threshold in seedling/early vegetative crops).³⁸

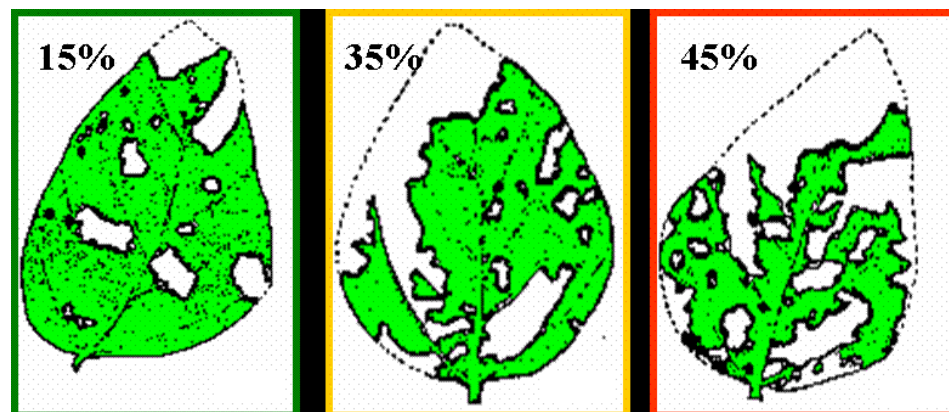

Figure 47: Different levels (%) of defoliation are shown in the figure below. Note how the measured defoliation seems to be less than that suggested by the observer's eye. (Source: Australian Oilseeds Federation)

7.3.5 Quality-based or preventative thresholds

A preventative pest threshold is a pest population that is less than the pest population required to cause 'critical damage' in a crop. In this context, 'critical damage' occurs when a certain quality standard (such as % damaged seeds) is breached and attracts significant discounts. The threshold is set lower than the critical pest population to avoid this quality reduction⁷.

Since seed quality is the critical pricing factor in summer pulses including edible soybeans, preventative thresholds are used for podsucking bugs rather than a yield-based threshold.

³⁷ Australian Oilseeds Federation (2013), Better Soybeans manual http://www.australianoilseeds.com/soy-australia/Soybean_Production

³⁸ Australian Oilseeds Federation (2013), Better Soybeans manual http://www.australianoilseeds.com/soy-australia/Soybean_Production

Example: In an 'average sized' (1500 seeds/m²) crop of edible soybeans, >3% of seeds are damaged when GVB numbers exceed 0.6 adult bugs per square metre. Thus 0.6 GVB per square metre is a critical pest population in edible soybeans. In practice, action is usually taken before the critical population is reached, usually when populations reach 70% (0.7) of the critical population, in this case at 0.4/m². In practice also, GVB populations increase as podfill progresses, and will be many times greater by pod ripening. But because the threshold is based on bug damage spread over a 35 day period, there is some leeway in delaying spraying slightly without compromising crop quality.

If bug populations exceed this critical level of 3% damaged seeds, the bonus for edible quality is lost and crop value can be downgraded by up to \$400/ha (i.e. by many times the cost of control). The preventative or action threshold in soybeans is therefore set at 2% bug damage to ensure the critical damage level is not reached or exceeded.

This type of threshold is therefore quite different from a yield-based threshold where there is no hefty monetary penalty if the threshold is slightly exceeded.

Because quality thresholds are usually very low, thorough scouting for podsucking bugs is essential. Inadequate sampling may very likely underestimate bug numbers.

For *helicoverpa*, seed staining in holed pods is not an issue. Recent mungbean trials show that each larva only stains 10% as many seeds as a GVB and the same is likely to apply in soybeans.³⁹

7.3.6 Thresholds for immature pests

Since most crop damage is caused by large caterpillars, bug nymphs, and adult bugs, the question is often asked about how to factor young larvae and nymphs into thresholds and damage estimates.

For caterpillar pests, thresholds often assume that small larvae will complete their development if not controlled, thus inflicting the maximum possible damage. However, in practice many larvae are attacked by predators, killed by disease, or even just blown off the crop before they reach a damaging size. For this reason, there is more leeway in decision making if the majority of caterpillars present are only small (i.e. more might be tolerated), particularly if large numbers of predators are present, and naturally occurring disease is observed. The high early mortality of small larvae is also likely to cancel out any sampling inefficiencies. One way to assess if natural control agents are effective in your crop is to assess changes in larval size, as well as numbers. If the majority of larvae remain small, then most larvae are being 'taken out' before they reach a damaging size.

For podsucking bugs, small nymphs are less damaging than large nymphs and are more susceptible to attack by ants and spiders. The damage potential of green vegetable bug nymphs has been scientifically determined to quantify their overall damage potential in adult GVB equivalents. While large nymphs are nearly as damaging as adults (90% or greater for instars 4 and 5), the damage potential of young nymphs is very low (10 and 25% for instars 1 and 2 respectively) because many will not survive to adulthood. However, recent sampling trials (April 2009) show that beat sheet sampling significantly underestimates the number of small nymphs (instars 1 and 2) by approximately 90%, medium nymphs (instar 3) by 30%, and adults by 50%. In contrast, beat-sheet counts for large nymphs (instars 4 and 5) are pro rata (i.e. all large nymphs present are detected). As a result, nymphal mortality is assumed to be cancelled out by sampling inefficiency, and the conversion factors to adjust nymph counts to adult equivalents have been revised.

Multi-pest situations: Where a number of pests causing similar damage are present, it is easier to express their combined damage potential in 'standard-pest equivalents'. A classic example is for podsucking bugs, where green vegetable bug (GVB) is the designated 'standard bug', and other species are converted to adult GVB equivalents. Podsucking bugs of different ages can also be converted into GVB equivalents to

³⁹ Australian Oilseeds Federation (2013), Better Soybeans manual http://www.australianoilseeds.com/soy-australia/Soybean_Production

determine the damage potential. This is much easier than having a separate threshold for each species, and is the only workable solution where more than one species is present.

If a number of podsucking bug species of varying ages are present, calculate the damage potential in GVB adult equivalents as follows.

Converting pod sucking bugs to (1) Green Vegetable Bug Equivalent (GVBEQ) and then to (2) Green Vegetable Bug Adult Equivalents (GVBAEQ):

1. Green vegetable bug equivalent

Green vegetable bugs (GVB) and brown bean bugs (BBB) are equally damaging to pulse crops but green vegetable bugs (GVB) are considered a more important pest due to their abundance, widespread distribution and rate of reproduction. The damage potential of other pod sucking bugs is not as great as GVB but they can cause severe damage when present in large numbers. To determine the damage potential of different pod sucking bug species, they must be converted to GVBEQ as shown in the table below:

Table 4: Damage potential of pod sucking bug species relative to GVB

Pod sucking bug species	Conversion to GVBEQ
Green vegetable bug (GVB) <i>Nezara viridula</i>	1.00
Brown bean bugs (BBB) <i>Riptortus & Melanacanthus</i> sp.	1.00
Redbanded shield bug (RBSB) <i>Piezodorus oceanicus</i>	0.75
Brown shield bug (BSB) <i>Dictyotus caenosus</i>	0.20

- For each bug stage (nymphs and adults) of each species, convert to GVBEQ by multiplying by the conversion factors above.
- For example – if three GVB and one RBSB are present in the crop then the GVBEQ of these bugs is $(3 \times 1.0) + (1 \times 0.75) = 3 + 0.75 = 3.75$ GVBEQ.
- If you also find two BSB, then the GVBEQ = $2 \times 0.2 = 0.4$ GVBEQ.
- The total number of GVBEQ in the crop are now $3.75 + 0.4 = 4.15$ GVBEQ

2. Green vegetable bug adult equivalents (GVBAEQ)

In earlier practices, bug nymph beat-sheet counts were corrected for likely mortality, as well as their lower-than-adult damage potential. Sampling efficiency was assumed to be near 100% (based on US guidelines).

However, recent sampling trials show that beat sheet sampling significantly underestimates the number of small nymphs (instars 1 and 2) by approximately 90%, medium nymphs (instar 3) by 30%, and adults by 50%. In contrast, beat-sheet counts for large nymphs (instars 4 and 5) are pro rata (i.e. all large nymphs present are detected).⁴⁰

As a result, nymphal mortality is assumed to be cancelled out by sampling inefficiency, and the conversion factors to adjust nymph counts to adult equivalents have been revised.

Using the example above - if you find that the three GVB and one RBSB are 2nd instars instead of adults and the two BSB are 4th instars – an additional calculation is required to convert these instars into adult equivalents. This is because bug nymphs are less damaging than adults.

The table below provides the conversion factors to convert instars to green vegetable bug adult equivalents. The previous example shows 3.75 GVB equivalents as 2nd instars and 0.4 GVB equivalents as 4th instars.

⁴⁰ Australian Oilseeds Federation (2013), Better Soybeans manual http://www.australianoilseeds.com/soy-australia/Soybean_Production

Table 5: Conversion factors to calculate the damage potential of each bug-nymph instar in green vegetable bug adult equivalents (GVBAEQ)

Days to Harvest	Instar I	Instar II	Instar III	Instar IV	Instar V	Adult
28	0.44	0.61	0.76	0.87	0.96	1.00
35	0.54	0.69	0.81	0.90	0.97	1.00

Each instar is multiplied by the conversion factor and then added together to obtain the total damage potential. This can be calculated for 28 days or 35 days to harvest.

For example, at 28 days to harvest the overall Green Vegetable Bug Adult Equivalent (for the above figures) would be:

$$(3.75 \text{ GVBEQ} \times 0.61) + (0.4 \text{ GVBEQ} \times 0.87) = 2.29 + 0.35 = 2.64$$

In practice, spray decisions will be often made on the number of adult bugs alone. This is because when the sampling correction factor of 2 for beat sheet adult counts is applied, pre-corrected adult populations as low as 0.2-0.25/m² will be at threshold.⁴¹

7.3.7 Estimating/calculating crop size as required for podsucking bug thresholds

As podsucking bug thresholds are based on % bug damage, the threshold for your crop will depend on the size of the crop as measured by the number of seeds per unit area. The greater the number of seeds, the higher the threshold, and visa versa. The number of seeds can be determined as follows:

Researcher's method

- Determine the number of seeds per pod. Assess 10 random pods. There are usually 2-3 seeds per pod in soybeans, but some varieties may have 3-4 seeds.
- Estimate the number of pods per plant (assess 10 random plants, not just the biggest or tallest ones).
- Count the number of plants per metre (Use plant emergence counts).
- Calculated seeds per m² = seeds per pod x pods per plant x plants per metre row spacing (metres)

Experienced agronomist's method

- Estimate the crop's potential yield (kg/ha). (After looking at hundreds of crops, you should be on or very close to the money).
- Look up the number of seeds/kg for the variety in question (planting seed records).
- Calculated seeds/m² = (potential yield/10,000) x seeds/kg/ row spacing (m)

Well-grown crops should have at least 2000 seeds per square metre (2000/m²). The action threshold for a 2000 seeds/m² crop is approximately 0.5 GVB/m², equivalent to an uncorrected beat-sheet count of only 0.25 GVB/m².⁴²

⁴¹ Australian Oilseeds Federation (2013), Better Soybeans manual http://www.australianoilseeds.com/soy_australia/Soybean_Production

⁴² Australian Oilseeds Federation (2013), Better Soybeans manual http://www.australianoilseeds.com/soy_australia/Soybean_Production

7.3.8 Soybean thresholds at a glance

Table 6: Soybean thresholds based on beat sheet sampling and expressed in pests/m²

Pest	Crop stage	Threshold	Comments
Helicoverpa	Vegetative	6/m ² new threshold*	Lower in early vegetative and seedling crops
Cluster caterpillar	Vegetative	33% defoliation	Refer to defoliation figure
Loopers	Vegetative	33% defoliation	Refer to defoliation figure
Mirids	Budding, Flowering & early Podding	5-6/m ² (dimethoate)	Trials show no yield loss for mirid populations up to 5 per m ² .
Thrips	Budding, Flowering	4-6 per flower	Open and inspect flowers
Helicoverpa ^B	Budding to late Podfill	1-3/m ²	Based on a yield loss model.
Cluster caterpillar	Budding to Podding	3/m ²	Not as damaging as helicoverpa
Loopers ^B	Budding to Podding	15-20% defoliation	Refer to defoliation figure
Soybean aphids	Budding to Podding	250 aphids per plant	Check upper leaves & stem
Podsucking bugs ^C	Early to late Podfill	0.3-1.0 GVBAEQ/m ² **	** Double thresholds for bugs in crushing beans.

Note: Thresholds are based on beat sheet sampling and are expressed in pests/m².

^A Loopers are mainly leaf feeders in soybeans.

^B Inspect flowers and terminals for small helicoverpa larvae.

^C Expressed in green vegetable bug adult equivalents (GVBAEQ). Convert counts of other bug species and nymphs to GVBAEQ. One brown bean bug = 1GVB. One redbanded shield bug (*Piezodorus*) = 0.75 GVB.

* Replaces old 33% defoliation threshold which still applies for other caterpillar species.

Table 7: Economic threshold chart for helicoverpa in podding soybeans, based on a yield loss of 40kg/ha per larva per square metre (Rogers 2010). Cross-reference the cost of control versus crop value to determine the economic threshold (ET) (e.g. if the cost of control = \$40/ha and the crop value = \$600/t, the ET = 1.7). Spray helicoverpa only if they exceed the threshold which is the break even point.

Cost of Control (\$/ha)	Thresholds (larvae/m ²) at Soybean Crop Values listed below (\$/t)									
	\$ 350	\$ 400	\$ 450	\$ 500	\$ 550	\$ 600	\$ 650	\$ 700	\$ 750	\$ 800
\$ 20	1.4	1.3	1.1	1.00	0.91	0.83	0.77	0.71	0.67	0.63
\$ 25	1.8	1.6	1.4	1.3	1.1	1.04	0.96	0.89	0.83	0.78
\$ 30	2.1	1.9	1.7	1.5	1.4	1.3	1.2	1.1	1.00	0.94
\$ 35	2.5	2.2	1.9	1.8	1.6	1.5	1.3	1.3	1.2	1.1
\$ 40	2.9	2.5	2.2	2.0	1.8	1.7	1.5	1.4	1.3	1.3
\$ 45	3.2	2.8	2.5	2.3	2.0	1.9	1.7	1.6	1.5	1.4
\$ 50	3.6	3.1	2.8	2.5	2.3	2.1	1.9	1.8	1.7	1.6
\$ 55	3.9	3.4	3.1	2.8	2.5	2.3	2.1	2.0	1.8	1.7
\$ 60	4.3	3.8	3.3	3.0	2.7	2.5	2.3	2.1	2.0	1.9
\$ 65	4.6	4.1	3.6	3.3	3.0	2.7	2.5	2.3	2.2	2.0

Table 8: Economic threshold for green vegetable bug (GVB) in edible soybeans, based on a rate of damage of 80 harvestable seeds per adult bug per square metre. Spray bugs at the action threshold of 2% before the critical 3% damage level is reached. Note that thresholds increase in 'larger' crops as more bugs are required to inflict a given percentage (%) of damage. When mixed bug populations are present (adults & nymphs) convert their damage potential to green vegetable bug adult equivalents (GVBAEQ).

Note: Seeds per m² = Seeds per pod x Pods per plant x Plants per metre/row spacing (metres)

Crop size seeds/m ²	GVBAEQ to damage 2% of seeds - the action threshold
500	0.13
1000	0.25
1500	0.38
2000	0.50
2500	0.63
3000	0.75
3500	0.88
4000	1.00
4500	1.13
5000	1.25

More information

<http://finalreports.grdc.com.au/CSE111>

[Australian Oilseed Federation. Oilseed News 2008. Beneficials Can Beat Belligerent Bugs.](#)

7.4 Management of insect pest

7.4.1 Sampling, scouting, monitoring and record keeping

Correct and timely crop scouting/checking is essential to:

minimise the risk of crop damage due to undetected pest outbreaks

maximise the chance of effective control of pests - 'spray small or spray fail'

In general, soybeans are at greatest risk of pest attack from budding onwards. However, crops should be checked twice weekly from the early vegetative stage onwards. This is so biopesticides can be used in a timely manner against small larvae, should the need arise. Avoiding hard pesticides during the crop's vegetative stage is a key IPM strategy in soybeans.

The recommended method for sampling is the beat sheet. This is the best method for detecting podsucking bugs and other key pests. Visual checking in buds and terminal structures may also be needed to supplement beat sheet counts of helioverpa larvae and other minor pests. Sweep netting is hopeless in soybeans. Because of the soybean crop's dense canopy, only a tiny fraction of insects present in soybeans are captured in a sweep net.

A key problem with sampling soybeans is that many pests are very patchily distributed. Sufficient samples need to be taken to reasonably estimate the pest population.⁴³

What is a beat sheet?

A standard beat sheet (also known as a beat cloth) is made from yellow or white tarpaulin material with heavy dowel in a sleeve along each side. Beat sheets are generally between 1.3–1.5 m wide by 1.5–2.0 m deep, the larger dimensions being preferred for taller crops.

The extra width on each side catches insects thrown out sideways when sampling and the sheet's depth allows it to be draped over the adjacent plant row. This prevents insects being flung through or escaping through this row. The use of smaller beat sheets, such as small fertiliser bags, can reduce sampling efficiency by over 50%.⁴⁴

⁴³ Australian Oilseeds Federation (2013), Better Soybeans manual http://www.australianoilseeds.com/soy_australia/Soybean_Production

⁴⁴ Australian Oilseeds Federation (2013), Better Soybeans manual http://www.australianoilseeds.com/soy_australia/Soybean_Production

How to use the beat sheet

- Place the beat sheet with one edge at the base of plants in the row to be sampled.
- Drape the other end of the beat sheet over the adjacent row. This may be difficult in crops with very wide row spacing (1 metre or more) and in this case spread the sheet across the inter-row space and up against the base of the next row.
- Using a 1 metre long stick, shake the plants in the sample row vigorously over the beat sheet 5 – 10 times. This will dislodge the insects from the sample row onto the beat sheet.
- Reducing the number of beat sheet shakes per site greatly reduces sampling precision. Record type, number and size of insects on the beat sheet and record these on datasheets.
- One beat does not equal one sample. The standard sample unit is five (5) non-consecutive 1 m long lengths of row, taken within a 20 m radius (i.e. 5 beats = 1 sample unit). This should be repeated at 5-6 random locations in the field (i.e. 30 beats per field).
- The more samples that are taken, the more accurate is the assessment of pest activity, particularly for pests that are patchily distributed such as pod-sucking bug nymphs⁴⁵

Other tips when using the beat sheet

- Pod-sucking bugs, particularly green vegetable bugs, often bask on the top of the canopy during the early morning and are more easily seen at this time.
- Some pod-sucking bugs (eg. brown bean bugs) are more flighty in the middle of the day and are more difficult to detect when beat sheet sampling. Other insects are flighty no matter what time of day they are sampled (e.g. mirids, Monolepta and ladybirds), so it is important to count them first.
- In very windy weather, mirids and other small insects are likely to be blown off the beat sheet.
- Using a beat sheet to determine insect numbers is very difficult when plants are wet.

While the recommended method for sampling most insects is the beat sheet, visual checking in buds and terminal structures may also be needed to supplement beat sheet counts of larvae and other more minor pests. Visual sampling will also assist in finding eggs of pests and beneficial insects.

The more samples that are taken, the more accurate is the assessment of pest activity, particularly for pests that are patchily distributed such as podsucking bug nymphs.

However, there is always a compromise between accuracy and practicality as the number of samples needed to accurately assess pest populations is usually far higher than is logistically feasible to collect. The following minimum numbers of samples are recommended.⁴⁶

⁴⁵ Australian Oilseeds Federation (2013), Better Soybeans manual http://www.australianoilseeds.com/soy_australia/Soybean_Production

⁴⁶ Australian Oilseeds Federation (2013), Better Soybeans manual http://www.australianoilseeds.com/soy_australia/Soybean_Production

Table 9: Minimum number of samples recommended for assessing pest populations in soybeans

Pest	Method	Sample unit	Minimum no. of sample sites recommended*
Helicoverpa	Beat sheet	5 x 1m	6**
Podsuckers#	Beat sheet	5 x 1m	6-10 #
Soybean aphids	visual	25 plants	6
Loopers	Beat sheet	5 x 1m	6
Monolepta beetle	Beat sheet	5 x 1m	6
Thrips	Open flowers	25 flowers	6

* As few as 5 sample sites may be necessary if the decision is clear cut eg. if populations are very high or extremely low.

** This is the number of sample sites. Multiply by 5 to get number of individual samples.

Nymphs are notoriously patchy in distribution, hence more samples are desirable.

Correcting podsucking bug beat sheet counts for sampling inefficiencies

Recent sampling trials in soybeans show that beat sheet sampling significantly underestimates the number of podsucking bugs sampled with the beat sheet. While sampling inefficiencies for small and medium nymphs are likely to be cancelled out by higher mortality for these stages, adult counts require a 2 times correction. So accept the bug nymphal counts as is, but multiply adult counts by 2.

Beat sheet sampling is also likely to underestimate the numbers of small caterpillars present. However, sampling inefficiencies are likely to be cancelled by increased mortality for the early caterpillar instars (up to 90%).⁴⁷

Converting sample totals for different row spacing

Most thresholds are expressed as pests per square metre (pests/m²). Hence, insect counts in crops with row spacing less than one 1 m must be converted to pests/m² as follows”.

To convert to pests/m² divide the ‘average insect count per row metre’ across all sites by the row spacing in metres. For example, in a crop with 2 GVB/m on average, and 0.75 m (75 cm) row spacing, divide 2 GVB by 0.75 (i.e. 2/0.75 = 2.67 GVB/m²).⁴⁸

Keeping records

Accurately recording sampling data is critical for good decision making, and being able to review the success of control measures. Record or check sheets should show the following:

- numbers and types of insects found, including number of adults and immature stages
- size and stage of insects – this is particularly important for larvae and nymphs
- date and time
- weather conditions
- crop observations (e.g. crop stage, crop vigour). This is particularly critical if an insecticide treatment is required, as you need assess the efficacy of that spray with a post-spray check.⁴⁹

Details of spray operations should include:

- date
- time of day

⁴⁷ Australian Oilseeds Federation (2013), Better Soybeans manual http://www.australianoilseeds.com/soy_australia/Soybean_Production

⁴⁸ Australian Oilseeds Federation (2013), Better Soybeans manual http://www.australianoilseeds.com/soy_australia/Soybean_Production

⁴⁹ Australian Oilseeds Federation (2013), Better Soybeans manual http://www.australianoilseeds.com/soy_australia/Soybean_Production

- conditions (wind speed, wind direction, temperature, presence of dew and humidity)
- product used, including batch number
- product rate and water rate
- method of application including nozzle types and spray pressure
- any other relevant details

Consider putting the data collected into a visual form that enables you to see trends in pest numbers and plant condition over time. Being able to see whether an insect population is increasing, static or decreasing can be useful in deciding whether an insecticide treatment may be required.

To facilitate acceptance in export markets, the soybean industry has developed a 'grower declaration form' where details including insecticides used, and spray and harvest dates are recorded. These forms MUST be filled in correctly.⁵⁰

More information

<http://finalreports.grdc.com.au/DAQ00003>

7.4.2 Integrated Pest Management (IPM)

IPM is the term used for a wide range of tactics to (a) prevent pests from reaching damaging levels in crops and (b) if they do so, to manage the target pest in a way that is less likely to flare other pests such as silverleaf whitefly. By using a wide range of tactics to deal with pests, IPM removes the reliance on a single method of control, such as insecticides. IPM tactics include:

- conservation of natural enemies and introduced biological control agents
- through the use of soft selective pesticides and biopesticides
- regular crop monitoring of pest and beneficial insects
- the use of Economic Thresholds to rationalize pesticide use and avoid uneconomic sprays.
- host plant resistance including not spraying at crop stages when the crop is able to tolerate or compensate for significant pest damage, and the planting of resistant cultivars.
- cultural practices including agronomic practices that promote vigorous crops better able to tolerate pest attack, and crop hygiene.
- Area Wide Management to maximise the benefits of IPM practices.

The benefits of IPM are many and varied and include:

- regular scouting allow potential problems to be detected early and timely action to be taken
- IPM results in the strategic use of chemicals thus reducing health risks to growers and consumers
- strategic use of chemicals minimises the chance of pests developing resistance to pesticides
- reduced negative impact on the environment
- the use of soft pesticides conserves natural enemies to manage pests for free
- IPM leads to a more robust sustainable system that does not rely on one control method
- IPM allows growers to control insect pests in a more cost effective way⁵¹

IPM and pesticides

IPM does not necessarily mean the abandonment of pesticides for controlling pests. However IPM aims to reduce the frequency of pesticide applications. The use of

⁵⁰ Australian Oilseeds Federation (2013), Better Soybeans manual http://www.australianoilseeds.com/soy_australia/Soybean_Production

⁵¹ Australian Oilseeds Federation (2013), Better Soybeans manual http://www.australianoilseeds.com/soy_australia/Soybean_Production

thresholds ensures sprays are applied only when required. Over use of pesticides hastens the development of insecticide resistance, can lead to a resurgence of target pests, can create new pests, may increase residues in harvested seed, and increases off-target contamination.⁵²

Soft and hard pesticides

The adjectives “soft” or “selective” are frequently applied to pesticides in the context of IPM. Soft or selective pesticides kill pests but have a minimal impact on the beneficial insects attacking these pests. In contrast pesticides impacting on natural enemies are termed “hard”, “non-selective” or “broad spectrum”.

In practice there are varying degrees of softness and many products may be hard on one group of natural enemies, but relatively soft on another. The term “soft” does not imply a product to be of low toxicity to mammals, although many of the softest products, particularly bio-pesticides, have little or no impact on humans and other mammals.

The “hardness” of a product can often be mitigated by reducing the rate (where there is data showing no reduction in efficacy), or by delaying spraying for as long as possible. In general the later in the life of a crop a hard spray is applied, the less the likelihood of it flaring other pests, because there is less time between application and harvest.⁵³

IPM and organics

IPM is not necessarily the same as organic pest management, though many organic options are compatible with IPM. In fact, not all organic options are IPM compatible. For example, many botanically derived products such as pyrethrum adversely affect beneficial insects. Another organic product NEEM contains an active ingredient that affects female reproduction in mammals.⁵⁴

IPM and biological control

IPM is sometimes confused with classical biological control. Classical biological control involves the importation and release of exotic control agents (predators and parasites) to control (usually) exotic pests. This practice is used because there are no native control agents, or because the native ones are (or thought to be) ineffective.

IPM plays an important role in maximising the success of classical biological control. The reduction in the use of non-selective chemical sprays increases the survival of introduced control agents and hence their effectiveness, and improves their chance of establishment in a new environment.

One example of classical biological control in Australia is the introduction of the *Cactoblastis* moth to control prickly pear. A recent example in soybeans (and other crops) is the release of a small parasitic wasp, *Eretmocerus hayati* to control silverleaf whitefly.⁵⁵

The soybean IPM strategy

The basic IPM strategy for soybeans is to avoid non selective pesticides for as long as possible in order to foster a build-up of predators and parasites (ie. ‘go soft early’). This helps keep early pests in check and buffers the crop against pest attack during later crop stages.

⁵² Australian Oilseeds Federation (2013), Better Soybeans manual http://www.australianoilseeds.com/soy_australia/Soybean_Production

⁵³ Australian Oilseeds Federation (2013), Better Soybeans manual http://www.australianoilseeds.com/soy_australia/Soybean_Production

⁵⁴ Australian Oilseeds Federation (2013), Better Soybeans manual http://www.australianoilseeds.com/soy_australia/Soybean_Production

⁵⁵ Australian Oilseeds Federation (2013), Better Soybeans manual http://www.australianoilseeds.com/soy_australia/Soybean_Production

The recommendation for vegetative crops is to avoid spraying wherever possible and to only use biopesticides against above-threshold caterpillar pests. Tolerating low level pest activity encourages natural enemies in vegetative crops and buffers the crop against pest attack during the more susceptible flowering and vegetative stages. For soybeans, avoiding early disruptive pesticides is critical for preserving *Eretmocerus hayati*, an introduced parasite of silverleaf whitefly.⁵⁶

However, intervention may be required during podding, especially against pod-sucking bugs populations which peak during late podfill. Pod-sucking bugs cannot be ignored as they drastically reduce seed quality, as well as yield. Over 90% of seeds can be damaged if bugs are left unchecked.

Regular monitoring of pest numbers is critical in soybeans, especially with the onset of flowering and throughout podding, when crops become attractive to pod-sucking bugs, *helioverpa* and other pests.⁵⁷

What is needed for IPM to work?

Successful implementation of IPM requires growers to have knowledge of key components in the field that will guide sound decisions and forecasts.

These include:

- accurate pest and beneficial insect identification
- understanding pest lifecycles, biology and ecology
- understanding the impact of pest damage on crop quality at different pest densities
- knowing the effects of control methods on target pests, non-target pests and beneficial insects

Much of the essential knowledge can be gained from regular crop inspections, good record keeping and reading published information.⁵⁸

7.4.3 Insecticides

Insecticides are a key pest management tool in soybeans. However unnecessary spraying, or selection of the wrong pesticide, can flare secondary pests, hasten the development of pesticide resistance, contaminate the harvested product, increase operating costs and reduce profitability. Both short and long term factors must be considered, even in a relatively short duration crop such as soybeans.⁵⁹

Factors to consider when choosing an insecticide

- be aware of current insecticide groups/types, and of any recent de-registrations
- attributes of key registered insecticides
- key factors to consider when making the choice
- how to make rational post spray assessments
- legal aspects and responsibilities
- resistance status of groups/types

Insecticide groups

Insecticides can be grouped according to how they enter the target pest, their modes of action, and their chemical composition (insecticide group or family).

⁵⁶ H. Brier (2010) Integrated Pest Management in Australian Mungbeans and Soybeans – Swings, Roundabouts and Conundrums: https://www.grdc.com.au/uploads/documents/2010ASGCEditedPapersPDF/Brier_IPM_edited_paper.pdf

⁵⁷ Australian Oilseeds Federation (2013), Better Soybeans manual http://www.australianoilseeds.com/soy_australia/Soybean_Production

⁵⁸ Australian Oilseeds Federation (2013), Better Soybeans manual http://www.australianoilseeds.com/soy_australia/Soybean_Production

⁵⁹ Australian Oilseeds Federation (2013), Better Soybeans manual http://www.australianoilseeds.com/soy_australia/Soybean_Production

Route of entry – how they enter the target pest

- contact
- ingestion
- inhalation (fumigants)

To be effective, contact pesticides need to be absorbed through the external body surface. This contact can be either directly at the time of spraying, or indirectly with the pest picking up dried spray residues as it moves over the surface of the plant.

Many insecticides have both contact and ingestion activity, though one may be more important than the other. Some newer generation 'soft' insecticides are only 'activated' inside an insect's gut. This is one reason they can have a reduced impact against many beneficial insects (e.g. Steward, TracerII).

Systemic pesticides are those that can be moved (translocated) from the site of application to another site where they become effective (e.g. insecticides that are absorbed by foliage and translocated throughout the plant). Chewing and sucking pests will then ingest the insecticide along with plant tissues or fluid. Dimethoate is an example of a systemic insecticide.⁶⁰

Mode of action (i.e. how they kill pests and the body systems attacked)

- neurotoxins – most insecticides (e.g. pyrethroids, organophosphates and carbamates)
- metabolic inhibitors – interfere with essential body processes such as moulting
- insect growth regulators - are slower acting. Includes many of the newer generation 'soft' insecticides registered in cotton (but not pulses)
- pPhysical toxicants – such as oils, abrasive dusts
- biological infection – NPV (*Helicoverpa* virus) and Bt (bacterial toxin) - by ingestion, *Beauvaria* and *Metarhizium* fungi - through the pest's cuticle.⁶¹

Chemical structure (classification)

Insecticides are also grouped according to the chemical similarity, especially for the purpose of designing resistance management strategies.

The main insecticide groups to consider in soybeans and other summer pulse crops are:

- oxadiazines (e.g. indoxacarb (Steward EC) - a new generation product with low mammalian toxicity)
- Spinosyns (e.g. spinosad (TracerII) - a new generation low mammalian toxicity product – but which has been withdrawn from Australian grain/pulse crops for commercial reasons)
- Carbamates (e.g. thiodicarb (Larvin) and methomyl (Lannate, Marlin etc.))
- Organophosphates or OPs (e.g. chlorpyrifos (Lorsban), and dimethoate (Rogor))
- Synthetic Pyrethroids or SPs (e.g. deltamethrin (Decis), alpha cypermethrin (Dominex etc.))
- Biopesticides (e.g. NPV (ViVUSMax) and Bt (DipeISC)). Fungal biopesticides for bugs (e.g. *Beauvaria* and *Metarhizium*) are under development but are not yet registered.⁶²

⁶⁰ Australian Oilseeds Federation (2013), Better Soybeans manual http://www.australianoilseeds.com/soy_australia/Soybean_Production

⁶¹ Australian Oilseeds Federation (2013), Better Soybeans manual http://www.australianoilseeds.com/soy_australia/Soybean_Production

⁶² Australian Oilseeds Federation (2013), Better Soybeans manual http://www.australianoilseeds.com/soy_australia/Soybean_Production

Making the choice – factors to consider

When confronted with an above-threshold pest population, there are several factors to consider when selecting from the available insecticides. These include:

- is the product registered?
- efficacy against the target pest
- susceptibility of the crop to pest damage at the time in question
- impact on natural enemies
- resistance management status and conditions
- ability to control multiple target species
- withholding periods and export slaughter intervals
- toxicity to the environment and humans
- exclusion zones
- cost – both long and short term⁶³

Efficacy

A well chosen insecticide is one that gives good control, while minimising negative side effects such as enhancing the development of resistance or flaring secondary pests. Efficacy is often judged by the percentage kill and speed of kill. While many contact insecticides have a rapid knockdown effect, others (particularly those that rely on ingestion) have a period, often measured in days, before maximum kill is achieved. Users need to be aware of these differences between products.

The stage or size of insect targeted also influences efficacy, with larger insects generally more difficult to control. For example, the 'Critical Comments' on the Steward label state 'Target brown eggs and hatchling (neonates to 1st instar) to small larvae (2nd instar) when they reach the economic spray threshold and before they become entrenched in pods'.

Another important factor in determining efficacy is the level of residual control provided. Some insecticides provide very little residual control (e.g. dimethoate, methomyl), while others can provide residual control in the order of weeks if conditions are favourable, and where there is not growth dilution (e.g. Steward). As well, the rate used also has a considerable impact. For example, dimethoate at very low rates (e.g. $\leq 150\text{mL/ha}$ has very little activity against mirid nymphs hatching after spraying). Efficacy also depends on your ability to get the chosen product onto the target site, whether that is on the insect directly or the plant surfaces from where the insect picks up the insecticide.⁶⁴

Susceptibility of the crop to pest damage

If the crop is at a stage tolerant of considerable damage (e.g. 33% defoliation by loopers, or 7 *Helicoverpa* larvae/m² during the vegetative stage), there is no need for 100% pesticide efficacy. In this case a biopesticide with a 70% efficacy such as ViVUSMax for *helicoverpa*, or Dipel for loopers will suffice. This approach has 2 benefits - beneficial insects are conserved and more effective products such as Steward EC are reserved for later crop stages more susceptible to pest attack.⁶⁵

Impact on natural enemies

Even in short duration crops such as mungbeans, there are benefits in choosing the softer option where possible. Going soft early with highly selective products (e.g. NPV or Bt) conserves beneficial insects for later on when the crop is more susceptible to

⁶³ Australian Oilseeds Federation (2013), Better Soybeans manual http://www.australianoilseeds.com/soy_australia/Soybean_Production

⁶⁴ Australian Oilseeds Federation (2013), Better Soybeans manual http://www.australianoilseeds.com/soy_australia/Soybean_Production

⁶⁵ Australian Oilseeds Federation (2013), Better Soybeans manual http://www.australianoilseeds.com/soy_australia/Soybean_Production

attack). Going soft early reduces the risk of flaring pests such as helioverpa, and the need for follow up sprays to control those pests. For example, a low rate of dimethoate (200-250 mL/ha with salt adjuvant) controls mirids and reduces the risk of subsequent helioverpa attack. While helioverpa outbreaks don't always follow a dimethoate spray, the risk of this occurring is greatly increased with the full dimethoate rate (500mL/ha).⁶⁶

Resistance management strategies for your region or a particular product

In soybeans and other pulses, resistance management strategies place restrictions on the number of sprays per crop, rather than on the timing of applications (as in cotton). A specific example of a label restriction is:

From the Steward label: "No more than one (1) application per field for the crop's entire growth cycle".

Following the resistance management guidelines for helioverpa in particular is essential to ensure that this pest does not develop resistance to any current or new products.⁶⁷

7.4.4 Presence of other pests also requiring control

Selecting spray mixtures or products with dual or multi-pest activity (e.g. loopers and helioverpa) may be important where more than one pest species requires control. When mixing pesticides, always check beforehand that products are compatible. If still in doubt, mix a small amount and look for sedimentation.⁶⁸

Withholding periods and insecticide residues

Some products have relatively long withholding periods (WHPs) and producers should be aware of these. For example, Larvin (thiodicarb) and Steward (indoxacarb) have a 21-day WHP.

Harvesting a crop before the WHP has elapsed could increase the risk of exceeding minimum residue levels for particular markets. The presence or risk of residues may affect the marketability of the harvested product. The presence of excessive residues could jeopardise overseas markets for the whole Australian industry, especially if residues are from unregistered products.

Be aware of regulations regarding the feeding of contaminated crop residues to stock. Export Slaughter Intervals and related periods are not generally shown on the product label, and are best obtained from the manufacturer or SAFEMEAT. Note that the Export Slaughter Interval can be significantly longer than the withholding period.⁶⁹

Toxicity to the environment and humans

Be aware that many older products, particularly the OPs (e.g. chlorpyrifos) and carbamates (especially methomyl) are extremely toxic (schedule S7) poisons, and should be handled with caution. Note that users have a community and industry responsibility to minimise environmental, animal, surrounding crop and human contamination.⁷⁰

⁶⁶ Australian Oilseeds Federation (2013), Better Soybeans manual http://www.australianoilseeds.com/soy_australia/Soybean_Production

⁶⁷ Australian Oilseeds Federation (2013), Better Soybeans manual http://www.australianoilseeds.com/soy_australia/Soybean_Production

⁶⁸ Australian Oilseeds Federation (2013), Better Soybeans manual http://www.australianoilseeds.com/soy_australia/Soybean_Production

⁶⁹ Australian Oilseeds Federation (2013), Better Soybeans manual http://www.australianoilseeds.com/soy_australia/Soybean_Production

⁷⁰ Australian Oilseeds Federation (2013), Better Soybeans manual http://www.australianoilseeds.com/soy_australia/Soybean_Production

Exclusion zones

Many pesticides have stipulated minimum distances that treated crops must be away from livestock, fodder crops, waterways etc (i.e. boundary zones inside which the above must be excluded). Always check the labels as the distances for some products can be 100 m or more. Note that exclusion zones are being reviewed by the APVMA, and may be revised upwards, especially for hazardous insecticides and crop-dehabilitating herbicides such as 2,4-D.⁷¹

Cost

Cost can be important in determining which product is used. However, the cheapest is not always the best – or the cheapest. For example, synthetic pyrethroids are very cheap on a \$/per application basis, but the combined impacts of insecticide resistance (especially in *helicoverpa*) and flaring of secondary pests, can lead to a need for additional sprays, costs and worries. In many cases, a single application of a more expensive but more effective and selective option will provide the best economy.

Never use products that are not registered nor have an APVMA permit for use in whatever crop you are growing.⁷²

New generation insecticides, indoxacarb (Steward) and spinosad (Tracer II)

Steward EC (active ingredient - indoxacarb) and Tracer II (active ingredient - spinosad) are new more-selective insecticides targeting *helicoverpa* and other caterpillars. Both products have low mammalian toxicity (i.e. are much safer for human operators, domestic animals and wildlife). Indoxacarb is registered in soybeans and other pulse crops but Tracer II is being withdrawn from the Australian market for purely commercial reasons, and is most likely by now unavailable.

Steward is primarily an ingestion active product (i.e. it has to be eaten by larvae to be effective). Thorough coverage over the larval feeding surfaces (leaves, flowers and pods) is therefore important to achieve the best results. Steward also has some mirid activity, but is not recommended at high mirid pressure, and is best reserved for *helicoverpa* control. It is not registered or effective against GVB.

A key advantage of Steward is that it is moderately selective, with reduced impacts on non-target species (including many beneficial species) that may be important in suppressing *helicoverpa* and SLW populations below the economic threshold. Steward has some impact on predatory ladybirds but Queensland DAF (DPI) and CSIRO trials support the manufacturers' claims that products such as Steward have much less impact on a wide range of beneficial insects than older insecticide groups.⁷³

Altacor (active ingredient Chlorantraniliprole) has highly effective control of *Helicoverpa* spp (bean podborer, soybean looper, bean looper). Key strengths are its robustness, control, length of residual in the crop and safety to key beneficial insects.

Biopesticides – NPV (ViVUSMax) and Bt (DipelSC)

NPV (ViVUSMax) and Bt (DipelSC) are highly selective caterpillar biopesticides. They are generally not as effective as chemical pesticides, but have an important IPM fit as they have no impact on beneficial insects. NPV has the added advantage in that it can re-infect other larvae well after the initial spray event. Because NPV is a 'living pesticide', there is also very little risk of *helicoverpa* developing resistance to NPV-based products. Note that ViVUSMax has superseded VivusGold and that the registered rate of the new-more concentrated formulation is much lower at 150 mL of product/ha than the 375 mL/ha rate registered for VivusGold.

⁷¹ Australian Oilseeds Federation (2013), Better Soybeans manual http://www.australianoilseeds.com/soy_australia/Soybean_Production

⁷² Australian Oilseeds Federation (2013), Better Soybeans manual http://www.australianoilseeds.com/soy_australia/Soybean_Production

⁷³ Australian Oilseeds Federation (2013), Better Soybeans manual http://www.australianoilseeds.com/soy_australia/Soybean_Production

Biopesticides are best suited to targeting moderate pest populations. High populations may be targeted if crops are at a less vulnerable stage (e.g. vegetative), and 60-70% control is sufficient to bring populations back to non yield-threatening levels.

NPV and Bt should not be used against medium-large (or larger) helioverpa. Remember that NPV only kills helioverpa! Bt should only be used against very small cluster caterpillars, but is effective against medium-large loopers.

AminoFeed should be added at 1L/ha for best results with both products. Both are broken down rapidly by ultra violet light (UV), so they are best applied when UV levels are lower (i.e. not in the middle of the day). However temperature is also critical. If temperatures are too low in the early morning, larvae will not feed, and the product may have broken down by the time temperatures rise sufficiently to allow feeding. The manufactures of VivusGold recommend applications ideally be made when temperatures are $\geq 25^{\circ}\text{C}$, and definitely not when temperatures are $< 18^{\circ}\text{C}$.

Thorough coverage is essential when applying these ingestion-active products. Minimum spray volumes recommended for air and ground applications are 30L/ha and 100L/ha respectively. Considerable success has been achieved in coastal crops where spray volumes of 200-300L/ha have been applied with ground rigs. Maximise spray penetration into crops by using multiple fine* flat fan nozzles and setting the spray pressure of around 4 bars (*not $> 0.2\text{s}$). Spray volume can also be increased by using multiple nozzles.

Fungal-based biopesticide types are being developed for bug and mirid control. Beauveria and Metarhizium are fungi that occur naturally in the environment. These insect pathogens are harmless to humans and wildlife, and have little effect on beneficial insects. Fungi are unique biopesticides in that they infect insects through their cuticles. As with biopesticides, thorough coverage, target younger pests, and avoid strong sunlight (UV) also apply to fungal based products.⁷⁴

Carbamates (e.g. Larvin, Lannate)

Larvin (active ingredient - thiodicarb) is commonly used for helioverpa and looper control. While resistance levels within the *H. armigera* population to carbamates has declined in recent years, poor control is possible in late summer crops if it follows widespread use in earlier crops. Larvin may give some control of podsucking bugs but is not recommended as a primary bug pesticide.

Methomyl (e.g. Methomyl, Lannate, Marlin) is sometimes used against mixed helioverpa and bug populations, but performs poorly against podsucking bugs, especially in crops with dense canopies. Commercial experience has shown poor results against GVB, possibly because of its short residual activity, and it is generally not recommended. Note that methomyl is extremely toxic, with a very low oral LD50. Breathing in the vapour or spray drift is particularly dangerous.⁷⁵

Organophosphates or OPs (e.g. Dimethoate)

Organophosphates or OPs, an older pesticide group, contain some of the most toxic pesticides ever used (e.g. parathion). Except for chlorpyrifos (under permit in soil-insect baits) dimethoate (e.g. Dimethoate, Rogor) is now the only OP registered for use in pulses.

Dimethoate is a systemic pesticide that is very effective against mirids, most thrips (western flower thrips excepted), leafhoppers and aphids. However, dimethoate is not effective against podsucking bugs despite its being registered for their control.

At the full registered rate ($\geq 500\text{mL/ha}$) dimethoate has a marked impact on most key beneficial insects. However, QPI&F trials show that dimethoate at low rates (e.g. 200-

⁷⁴ Australian Oilseeds Federation (2013), Better Soybeans manual http://www.australianoilseeds.com/soy_australia/Soybean_Production

⁷⁵ Australian Oilseeds Federation (2013), Better Soybeans manual http://www.australianoilseeds.com/soy_australia/Soybean_Production

250 mL/ha) has markedly less impact on beneficials, while still being very effective against mirids. Dimethoate is less toxic to humans than earlier OPs, but every safety precaution must be taken when using this product.

Dimethoate is very sensitive to alkaline water and breaks down in less than 50 minutes in water with a pH of 9. If your water is alkaline, add a buffering agent such as LI700.⁷⁶

Organochlorines (Cyclodeines) (e.g. Endosulfan)

ENDOSULFAN IS NO LONGER REGISTERED POST EMERGENCE IN AUSTRALIAN PULSES.

Synthetic Pyrethroids or SPs (e.g. Alpha-Scud, Ballistic, Cypermethrin, Dominex)

Synthetic Pyrethroids (SPs) are a very broad-spectrum group of insecticides. They kill pod sucking bugs, loopers, most other pests, and most beneficials. However, they are only effective against small *Helicoverpa armigera* larvae (up to 5 mm long) due to high levels of resistance of *H. armigera* to this group of products.

Synthetic pyrethroids are the most disruptive chemical group to beneficial insects and spiders, due to their broad-spectrum and residual activity. Pyrethroids can flare *Helicoverpa*, mites, SLW and other pests.

With de-registration of endosulfan, deltamethrin (Decis) is now the only effective pesticide registered against GVB. Recent trial results show that redbanded shield bug (*Piezodorus oecanicus*) is not controlled by deltamethrin (nor alpha-cypermethrin). However, in QPI&F trials 60% control of *Piezodorus* was achieved when 0.5% salt (NaCl) adjuvant was added to tank mixes of deltamethrin.

Note: SPs are synthetic derivatives of natural pyrethrum, as used in organic crops. Natural pyrethrum is also a broad spectrum pesticide but breaks down quickly after spraying and doesn't have the residual impact of the SPs. In general, SPs are less toxic than OPs, but more toxic to humans than natural pyrethrum.⁷⁷

7.4.5 Post-spray assessments

Once crops have been sprayed for pests, it is essential to conduct post-spray assessments to ensure that a satisfactory level of control was achieved. Good control is usually >90% for chemical pesticides, and 70% for biopesticides. Post spray assessment should be done as soon as the specified re-entry period allows entry to the field. For most products this is 2-3 days after treatment (2-3 DAT). However with biopesticides, mortality may not occur until 5-7 DAT. Crops sprayed with chemical pesticides should be checked again at 7 DAT to check for re-invasion and biopesticide-sprayed crops again at 10-12 days. Regular twice-weekly sampling should continue until the crop is no longer susceptible to pest attack.

Sprays sometimes fail to work as effectively as required or expected. This can be due to several reasons (e.g. a bad batch of product, poor coverage, bad timing, adverse weather conditions, poor water quality, insecticide resistance, or too-high expectations of the product selected). Application problems (coverage, timing, water) and inappropriate product selection account for a large percentage of failures. Where a spray failure is suspected, detailed records can assist in trying to determine what might have been the cause of the apparent failure.

Spray failures are often due to heavy pest pressure. Where GVB pressure is high, crops are often re-infested by nymphs hatching from large numbers of GVB eggs present at but not controlled by spraying. This frequently occurs even where crops are sprayed with deltamethrin (e.g. Decis).

⁷⁶ Australian Oilseeds Federation (2013), Better Soybeans manual http://www.australianoilseeds.com/soy_australia/Soybean_Production

⁷⁷ Australian Oilseeds Federation (2013), Better Soybeans manual http://www.australianoilseeds.com/soy_australia/Soybean_Production

Re-infestation will also occur where there is prolonged *helicoverpa* pressure and crops are sprayed with products which have no impact on moths, and have very little or no residual activity (e.g. biopesticides). Uncontrolled moths continue to lay more eggs which give rise to more larvae that survive because there are no pesticide residues to kill them. It is also possible that pests have come in (post-spray) from elsewhere, particularly if there is a lot of activity in surrounding crops.

Apparent spray failures may also occur where pesticides are unable to reach the target pest, or where the damage has been inflicted before spraying occurs. An example of this is where small *helicoverpa* or podborer larvae are feeding inside flowers. Short residual pesticides such as methomyl usually break down before the majority of larvae emerge, resulting in imperfect control.⁷⁸

7.4.6 Legal issues

Registration

Insecticide users should be aware that all insecticides go through a process called registration, where they are formally authorised (registered) by the Australian Pesticide and Veterinary Medicine Authority (APVMA) for use:

- against specific pests
- at specified rates of product
- in prescribed crops and situations
- where risk assessments have evaluated that these uses are:
 - effective (against that pest, at that rate, in that crop or situation)
 - safe in terms of residues not exceeding the prescribed MRL (Maximum Residue Level), and safe to the crop itself (no phytotoxicity).
- not a trade risk⁷⁹

Labels

A major outcome of the registration process is the approved product label, a legal document, that prescribes the pest and crop situations where a product can be legally used, and how. Always read the label! The use of products for purposes or in manners not on the label involves potential risks. These risks include reduced efficacy, exceeded maximum residue limits (MRL) which can have trade implications and the risk of litigation.

Be aware that pesticide-use guidelines on the label are there to protect product (grain) quality and Australian trade by keeping pesticide residues below specified MRLs. MRLs in any crop are at risk of being exceeded or breached where pesticides:

- are applied at rates higher than the maximum specified
- are applied more frequently than the maximum number of times specified per crop
- are applied within the specified withholding period (WHP) (i.e. within the shortest time before harvest that a product can be applied)
- are not registered in the crop in question

All of the above have the potential to jeopardise the marketing of Australian pulse crops.⁸⁰

⁷⁸ Australian Oilseeds Federation (2013), Better Soybeans manual http://www.australianoilseeds.com/soy-australia/Soybean_Production

⁷⁹ Australian Oilseeds Federation (2013), Better Soybeans manual http://www.australianoilseeds.com/soy-australia/Soybean_Production

⁸⁰ Australian Oilseeds Federation (2013), Better Soybeans manual http://www.australianoilseeds.com/soy-australia/Soybean_Production

MSDS

Material Safety Data Sheets (MSDS) are essential reading. They document the hazards posed by insecticides, and the necessary and legally enforceable handling and storage safety protocols.⁸¹

Permits

In some cases a product may not be fully registered but is available under a Permit with conditions attached, which often require the generation of further data for eventual full registration.⁸²

APVMA

The national body in charge of administering these processes is called the APVMA (the Australian Pesticides and Veterinary Medicines Authority) and is based in Canberra.

From the APVMA website:

“The APVMA administers the national Registration Scheme for Agricultural and Veterinary Chemicals. The scheme registers and regulates the manufacture and supply of all pesticides and veterinary medicines used in Australia, up to the point of wholesale sale.”

“The APVMA sets maximum residue limits (MRLs). An MRL is the highest concentration of an agricultural or veterinary chemical residue permitted in food or animal feed. MRLs are used to check whether chemical users are following the directions on the label. MRLs are usually set well below the level that would harm health. When an MRL is exceeded, it usually indicates a chemical is being misused, rather than a public health or safety concern.”

“State and territory governments regulate the use of agricultural chemicals after they have been sold. These regulations cover:

- basic training requirements for users
- licensing of commercial pest control operators and ground and aerial spray operators
- residue monitoring
- arrangements to enforce the safe use of chemicals, including the use of codes of practice, spray-drift guidelines and other user awareness raising initiatives

State Government regulations are therefore relevant in determining the legality or otherwise of deviations from label conditions.

Where soybeans are grown in new production areas (e.g. coastal Queensland), they may encounter new pests for which registered chemicals (or permits) are not always available.

⁸¹ Australian Oilseeds Federation (2013), Better Soybeans manual http://www.australianoilseeds.com/soy_australia/Soybean_Production

⁸² Australian Oilseeds Federation (2013), Better Soybeans manual http://www.australianoilseeds.com/soy_australia/Soybean_Production

7.4.7 Soybean insecticides

Table 10: Insecticides registered in soybeans – June 2012 (check the latest status on APVMA/PUBCRIS websites)

Pest	Pesticide/ Hardness [‡]	Trade names	Rate/ ha*	Registration status	WHP# (days)	Comments
Helicoverpa	indoxacarb	Steward	0.4L	®	21	Only 1 spray per crop*
	thiodicarb	Larvin	0.5L - 0.75L	®	21	Target larvae < 7mm for best results
	methomyl	Marlin, Nudrin	0.5-2L	®	7	Target larvae < 7mm for best results. Highly toxic to humans
	deltamethrin	Decis Options Ballistic	0.5L	®	7	Target larvae < 5mm for best results
	alpha- cypermethrin	Dominex 100	0.3-0.4L	®	7	Target larvae < 5mm for best results
	<i>Helicoverpa</i> NPV	Gemstar LC ViVUSMax	0.375L 0.150L	® ® - Pivot	NA	Target larvae < 7-10mm Preferred vegetative options
Loopers	Bt	Dipel, Farmoz Btk	1-4L	®	NA	Target hatchlings for best results
	methomyl	Marlin, Nudrin	1.5L	®	7	Only use post flowering. Highly toxic to humans
	deltamethrin	Decis Options Ballistic	0.5L	®	7	Only use post flowering
Soybean loopers	Bt	Dipel, Farmoz Btk	1-4L	®	NA	Preferred option unless extreme pressure
	indoxacarb	Steward	0.2L	®	21	Only 1 spray per crop*
GVB	Bt	Dipel, Farmoz Btk	1-4L	®	NA	Preferred pre-flowering option
	deltamethrin	Decis Options Ballistic	0.5L	®	7	Most effective option
Mirids	trichlorfon	Lepidex	1.2L	®	14	Shorter control than Decis
	dimethoate ^P	Dimethoate	0.5L	®	7	Very effective but rarely needed
Aphids	indoxacarb	Steward EC	0.4L + salt	®	21	Add salt (NaCl) @ 5g/L spray volume by ground (100L/ha) or 10g/L by air (30L/ha)
	dimethoate ^P	Dimethoate	0.5L	®	7	Act if >threshold by flowering
Jassids, Leafhoppers	dimethoate ^P	Dimethoate	0.34L	®	7	rarely a problem in soybeans
Monolepta beetle	indoxacarb	Steward	0.2L	®	21	Only 1 spray per crop*
Field cricket	chlorpyrifos	Chlorpyrifos 500	grain bait	®	NA	0.1L/2.5 kg grain bait
Two-spotted mite	abamectin	Tradelands abamectin 18EC	0.3L	®	28	Act if > 33% of plants infested. Using soft options against other pests greatly reduces the risk of mite attack.

WHP = withholding period (days).

* Maximum rate allowed for on label.

® = Registered.

Pivot = registered through central pivot.

ViVUSMax is a more concentrated NPV product than Gemstar, hence the lower rate.

Trade names listed are examples only & do not signify preference over products not listed (because of limited space).

^P Permit 13155 – dimethoate against all pulse/grain pests it was previously registered for- valid to 5 October 2012.

Check the latest status of the dimethoate permit on the APVMA/PUBCRIS websites before using post 5 October 2012

[‡] Softness/Hardness Note: 'Soft' products are selective, ie. have little to no impact on non-target species

From: Wilson et al. (2007) Impact of insecticides and miticides on beneficials in Australian cotton. Cotton Pest Management Guide 2007-08. pp. 29-30. CRC & NSW DPI Publication. ISSN1442-8792.

Highly Selective,
ie. Extremely Soft

Moderately Selective,
especially at lower
rates

Hard - Disruptive to
beneficials

Extremely Hard

7.4.8 Making control decisions

Making control decisions may seem daunting given: a) number of pests attacking soybeans; b) the uncertainty of what might happen if you do nothing; and c) the number of pesticide options available. However, decision making is easier if you break it down into the following logical steps.

What stage is the crop?

- This will tell you in advance what pests are likely to be a problem in the crop and if the crop is susceptible to a given pest at that stage.

For example, podsucking bugs won't be an issue in vegetative or even flowering crops

What pest(s) is/are present? – this is critical

- Is it one of the major pests (e.g. heliothis or podsucking bugs)?

These are the ones to worry about most. Make sure you can tell the difference between the major and minor pests, and beneficial insects

- Are there any other pests present - such as silverleaf whitefly?

Other pests might be controlled by whatever you spray the main pest with, alternatively they may not, or they could even be flared if the wrong pesticide is used

What size/stage are the pests?

- Pest size can be critical as some pesticides, particularly biopesticides, are only effective against the early stages of the target pest (e.g. ideally target heliothis ≤ 7 mm with NPV).

Note that to catch pests when they are still small, you need to sample regularly, particularly in hot weather when pests grow more quickly.

What type of damage are you seeing?

- This will provide further clues as to the identity of the pest, and the severity of the infestation.

You need to ensure the pests are still present or haven't ceased feeding because they are pupating.

How large and vigorous is the crop?

- A large vigorous crop is better able to compensate for damage than a small stressed crop.
- A large soybean crop with a large number of set pods will suffer lower % seed damage than a small crop with fewer pods, for a given podsucking bug population.

So you will need to determine the number of seeds per square metre to determine the podsucking bug threshold for your specific crop.

Are the beneficial insects present keeping the pest/s in check?

- They may be holding other key pests in check – such as whitefly.
- Look for evidence such as parasitized whitefly nymphs, diseased caterpillars, predatory bugs attacking caterpillars, and the failure over time of small caterpillars to progress to large ones.
- If so, you need to consider a more selective option that has minimal impact on the beneficials and doesn't flare whitefly or other pests.
- Alternatively, the beneficials may do the job for you, so keep checking the crop to monitor their progress.
- Beneficials are often very good pest indicators.

If there are lots of ladybirds there will either be aphids or whitefly present in your crop.

Are the pests above threshold?

- If not, it is uneconomic to spray.
- If not much above threshold, you might consider a biopesticide if one is registered.

This would be particularly appropriate for helioverpa in vegetative soybeans when a near perfect kill is not required, and a 60-70% kill will be sufficient to bring the population down below threshold (6/m²).

- If pests are well above threshold, you will need a product with high efficacy (85-90% kill).
- Are you using the recommended sampling protocols so that your pest counts can be accurately compared to thresholds derived using the same sampling protocols?

Are there any resistance management guidelines for the pesticide you are considering?

- Have you used it previously in the crop?
- Remember that only one indoxacarb (Steward) spray is allowed per soybean crop.

How close to harvest is the crop?

- As you get closer to harvest pesticide withholding periods (WHP) must be considered.
- If time to harvest is shorter than the WHP for a particular pesticide, you can no longer legally spray that pesticide in the crop.

Will it be grazed post-harvest?

- If a crop is to be grazed post harvest, export slaughter intervals (ESI) may come into play.
- These can be markedly longer than the crop WHP.
- Export slaughter intervals also come into play if adjoining crops/pasture are contaminated.

Are you able to deliver the pesticide to the target?

- Do you have the right nozzles, spray volume and pressure to penetrate the canopy?
- Do you have good quality spray tank water, ie. close to neutral?

Are the meteorological conditions right for the pesticide you are using?

- Is the wind speed too low or high?
- Is it too cold or hot?
- Are UV levels too high?

What is the risk of off target contamination?

- What are the weather conditions – high wind speed, temperature inversions?
- Proximity to other crops/pasture – do you know what the exclusion zones are?
- How close is the neighbour's house?

What about your safety?

- Do you have adequate safety gear?
- Have you read the MSDS for the pesticide in question?
- Remember, some older pesticides such as methomyl are extremely toxic.

Post-spray assessments;

- Always make post spray assessments to determine the efficacy of whatever pesticide is applied.
- For fast-acting pesticides, check crops as soon as the re-entry period elapses.
- For slow acting pesticides (e.g. biopesticides) wait until significant mortality is likely.⁸³

⁸³ Australian Oilseeds Federation (2013), Better Soybeans manual http://www.australianoilseeds.com/soy_australia/Soybean_Production

7.5 Beneficial insects

Natural enemies of insect pests are also referred to as beneficial insects. A natural enemy may be a predator or a parasitoid. Spiders, birds and insect diseases are also classified as natural enemies.

Predators consume several to many prey over the course of their development, they are free living and are usually as big as or bigger than their prey. Predators may be generalists, feeding on a wide variety of prey, or specialists, feeding on only one or a few related species.

Parasitoids are similar to parasites but, while true parasites usually weaken but rarely kill their hosts, parasitoids always kill the host insect. In contrast to predators, parasitoids develop on or within a single host during the course of their development.

Most parasitoids are highly host specific, laying their eggs on or into a single developmental stage of only one or a few related host species. They are often described in terms of the host(s) stages within which they develop. For example, there are egg parasitoids, larval parasitoids, larval-pupal parasitoids (eggs are laid on or in the larval stage of the host, and the host pupates before the host dies), true pupal parasitoids, and a few species that parasitise adult insects.

Conserving or encouraging natural enemies is important because a great number of beneficial species exist naturally and help to regulate pest densities. The widespread injudicious use of non-selective insecticides can decimate natural enemy populations and lead to a flaring of pests. The widespread use of non-selective pesticides can also negate classical biological control introductions, such as the tiny wasp *Erotmocerus hayati* imported by CSIRO to control silverleaf whitefly.

Among the practices that conserve and favour natural enemies are the following:

- Recognizing beneficial insects. Learning to distinguish between pests and beneficial insects is the first step in determining whether or not control is necessary.
- Minimizing insecticide applications. Most insecticides kill predators and parasitoids along with pests. Natural enemies are often more susceptible than pests to commonly used insecticides. However many newer pesticides are far more selective than the older products they are replacing.
- Using selective insecticides or using insecticides in a selective manner. Several insecticides are toxic only to specific pests and are not directly harmful to beneficials. For example; microbial insecticides containing different strains of the bacterium *Bacillus thuringiensis (Bt)*, are toxic only to caterpillars, certain beetles, or certain mosquito and black fly larvae.
- Maintaining ground covers, standing crops, and crop residues. Many natural enemies require the protection offered by vegetation to survive. Ground covers supply prey, pollen, and nectar (important foods for certain adult predators and parasitoids), and protection from the weather.⁸⁴



Figure 48: White collared ladybird, key aphid predator. (Photo: Australian Oilseeds Federation)

⁸⁴ Australian Oilseeds Federation (2013), Better Soybeans manual http://www.australianoilseeds.com/soy_australia/Soybean_Production

7.5.1 Use of the predator to pest ratio in spray decisions

The predator to pest ratio (as developed in cotton) gives a rough guide as to the potential impact of beneficials, especially against *Helicoverpa* and similar caterpillars. Calculation of the ratio includes *Helicoverpa* eggs and very small (VS) plus small (S) larvae (1-7 mm) per metre assessed using visual and beat sheet sampling. It does not include medium (M) or large (L) larvae since many of the common small predatory insects are not effective on these stages (but predatory shield bugs still are). Total predators per metre are assessed using a beat sheet and visual check. To be confident in the ratio, at least 3 of the most common predators should be present per sample including ladybirds, red and blue beetles, damsel bugs, big-eyed bugs, assassin bugs, predatory shield bugs and lacewings.

The predator:pest ratio is calculated as:

Predators per metre/(*Helicoverpa* eggs + larvae (VS + S))

If this ratio is 0.5 or higher, then predators will generally provide effective control of *Helicoverpa* spp. If the ratio is less than 0.5 then beneficials may still give useful partial control of *Helicoverpa*, and should still be preserved through the use of soft selective pesticides if *Helicoverpa* are above threshold.

Table 11: Key beneficial groups and the pests they attack⁸⁵

Parasitoids	Pests Attacked
<i>Ichneumonid</i> wasps including orange caterpillar parasite, orchid dupe, two-toned caterpillar parasite and banded caterpillar parasite	Larva of noctuid caterpillars including <i>Helicoverpa</i> , armyworms, cutworms and loopers except the banded caterpillar parasite which only parasitizes pupae
<i>Microplitis</i> wasps	<i>Helicoverpa</i> larvae – small to medium sized
Tachinid flies	Larva of noctuid moths
<i>Trichogramma</i> sp. wasps	Eggs of noctuid moths
<i>Trichopoda</i> flies	GVB and green stink bug (adults and 5th instar nymphs)
Predatory Insects and Spiders	Pests Attacked
Ants	Eggs and larvae of moths, bug nymphs
Apple dimpling bug	Moth (Lepidoptera) eggs, very small larvae and mites
Assassin bug	Range of insects including <i>Helicoverpa</i> and mirids
Big eyed bug	Soft bodied insects, Lepidoptera eggs and mites
Brown smudge bug	Lepidoptera eggs, aphids, jassids and mites
Common brown earwig	Larvae and pupae of Lepidoptera
Damsel bug	Lepidoptera eggs and larvae, mites and mirid eggs
Glossy shield bug	Larvae of Lepidoptera
Hoverflies	Aphids
Lacewings	Aphids, Lepidoptera eggs and small larvae
Ladybeetles	Aphids, mites, Lepidoptera eggs and small larvae
Pirate bugs	Thrips and Lepidoptera eggs
Predatory shield bug	Lepidoptera larvae
Red and blue beetle	Lepidoptera eggs and small <i>Helicoverpa</i> larvae
Spiders	Generalist predator, including moths, larvae, eggs, bug nymphs and other spiders. Very underrated predators.
Thrips	Mites

⁸⁵ Australian Oilseeds Federation (2013), Better Soybeans manual http://www.australianoilseeds.com/soy_australia/Soybean_Production

Pathogens	Pests Infected
Bacteria eg <i>Bacillus thuringiensis</i>	Lepidoptera
Fungal diseases (including <i>Beauveria</i> , <i>Nomuraea rileyi</i> and <i>Metarhizium</i>)	<i>Helicoverpa</i> , loopers, cluster caterpillars, armyworms, mirids and podsucking bugs.
NPV (Nuclear Polyhedrosis Viruses)	<i>Helicoverpa</i> , loopers and cluster caterpillars
	NOTE: Different NPV viruses attack each of the above caterpillars. <i>Helicoverpa</i> NPV and its commercial derivatives (e.g. ViVUSMax and Gemstar) are specific to <i>Helicoverpa</i> sp.

7.6 Key parasitoids and predators

7.6.1 Large predatory bugs



Figure 49: Glossy shield bug (*Cermatulus nasalis*) adult (12 mm) and nymph (9 mm). (Photo: Australian Oilseeds Federation)



Figure 50: Spined predatory shield bug adult (11 mm) (*Oeochalia schellenbergii*) and nymph (8 mm) (Photo: Australian Oilseeds Federation)



Figure 51: Large assassin bug (30 mm) (Photo: Australian Oilseeds Federation)

7.6.2 Small predatory bugs



Figure 52: Damsel bug (12 mm) (Photo: Australian Oilseeds Federation)



Figure 53: Big-eyed bug (3 mm) (Photo: Australian Oilseeds Federation Foundation)



Figure 54: Apple dimpling bug (2.5 mm) (Photo: Australian Oilseeds Federation)



Figure 55: Brown smudge bug adult and nymph (5 and 3 mm).

7.6.3 Predatory beetles



Figure 56: Three-banded ladybird adult



Figure 57: Three-banded ladybird larvae (7 mm).



Figure 58: White-collared ladybird.



Figure 59: Mealybug ladybird *Cryptolaemus* adult (4 mm).



Figure 60: Mealybug ladybird *Cryptolaemus* larvae (9 mm).



Figure 61: Red and blue beetle (5 mm).



Figure 62: Carab beetle (17 mm).



Figure 63: MS and larvae (16 mm). (Photos: Australian Oilseeds Federation)

7.6.4 Wasp parasitoids – of helicoverpa and other caterpillars



Figure 64: *Trichogramma* egg parasite.



Figure 65: *Microplitis* with pupae (5 mm) made by parasite after it has exited its dying *helicoverpa* host.



Figure 66: *Microplitis* pupae beside *helicoverpa* host.



Figure 67: Orange caterpillar parasite.



Figure 68: Orchid dupe parasite. (Photo: Australian Oilseeds Federation)

7.6.5 Fly parasitoids



Figure 69: Trissolcus wasp on GVB eggs, Trichopoda (8 mm) and eggs on GVB host.



Figure 70: Tachanid fly parasitoid of caterpillars Carcelia sp. (Photo: Australian Oilseeds Federation)

7.6.6 Hoverflies - key aphid predators



Figure 71: Hoverfly adult and maggot larvae (9 mm). Only the hoverfly larvae attacks its prey. (Photo: Australian Oilseeds Federation)

7.6.7 Lacewings – key aphid predators



Figure 72: Green lacewing adult (12 mm) and larvae (6 mm) with frass on back. Green lacewing eggs on stalks and brown lacewing adult (8 mm). (Photo: Australian Oilseeds Federation)

SECTION 8

Nematode management

8.1 Background

Nematodes have the potential to become serious pests of soybean.

There are three important nematode pests to be aware of: soybean cyst nematode; reniform nematode; and root-knot nematode.

- Soybean cyst nematode (SCN) is the most important pest of soybean worldwide. It is native to Asia (China, Japan and Korea) but is not yet found in Australia. SCN is found in most countries where soybean production occurs and has been recorded in China, India, Indonesia, Japan, Korea, Egypt, Canada, United States of America, Argentina, Brazil, Chile, Columbia, Ecuador, Paraguay, Italy, Russia and the United Kingdom. In the US, yield losses from SCN are greater than for any other disease. Australia needs to recognise the quarantine risk of introducing SCN. Exotic Plant Pest Hotline: 1800 084 881.
- Reniform nematode is found in Australia in the coastal areas north of Bowen. It should not be confused with another species (*Rotylenchulus parvus*) which is widespread on sugarcane and other grasses.
- Root-knot nematode (RKN) is in Australia and has the potential to cause problems on most legumes, such as soybeans grown in rotation with sugarcane. It is common on sugarcane in sand, sandy loams and well-structured volcanic soils, but will never cause problems in clay, clay loam and alluvial soils. A short, bare fallow is a useful control measure for RKN.

SECTION 9

Diseases

Soybean crops can be prone to a range of fungal and bacterial diseases. Good crop rotational practices, careful varietal selection and thorough decomposition and incorporation of crop residues will minimise disease occurrences. Avoid planting soybeans after other legumes or sunflowers.¹

9.1 Name and description of disease (when and how to identify)

9.1.1 Fungal diseases

Soybeans may be affected by the following fungal diseases:

- seedling root rots
- charcoal rot
- Phytophthora root rot
- sclerotinia stem rot
- sclerotium base rot
- pod and stem blight
- Rhizoctonia root rot
- rust
- downy mildew
- purple seed stain
- powdery mildew

9.1.2 Seedling root rots (*Rhizoctonia solani*, *Phytophthora sojae*, and *Pythium species*)

Symptoms include seeds rotting in the ground and death of young seedlings after emergence. Young seedlings often display red-brown lesions on the roots and along the lower stem near ground level. Outbreaks of *Pythium* and *Phytophthora* are most likely under cold, wet conditions, whereas *Rhizoctonia* is favoured by rainfall followed by warm weather.

Species of *Pythium* and *Phytophthora* survive for a long time as thick-walled oospores. During saturated soil conditions and in the presence of soybean root exudates, oospores germinate to produce sporangia, in which motile (mobile) zoospores develop. The zoospores swim towards the roots, where they encyst and later germinate. The germ tubes then invade the roots, which start to rot. *Rhizoctonia* survives mainly in infected stubble, so soybeans growing through soybean or other stubble are at high risk.

To minimise losses:

- avoid sowing deeper than 50 mm
- use high-quality seed

¹ Australian Oilseeds Federation, Queensland Soybean Grower Guidelines: http://www.australianoilseeds.com/_data/assets/pdf_file/0010/7669/Queensland_Soybean_Grower_Guidelines.pdf

- minimise the amount of stubble in the vicinity of the sowing line
- use crop rotation

Fungicidal seed dressings containing thiram or metalaxyl may be worth considering. Apply these fungicides to the seed and allow to dry before inoculating with soybean rhizobia. Metalaxyl will control seedling losses only from *Phytophthora* and *Pythium*, but infection by *Phytophthora* is possible later in the growing season.²

9.1.3 Charcoal rot (*Macrophomina phaseolina*)

This pathogen can be found in all agricultural soils in Australia. Symptoms usually appear from pod-fill to maturity with affected plants dying prematurely, but seedlings can die when there is hot, dry weather during emergence. Crops under severe moisture or heat stress are particularly susceptible and even irrigated crops can be badly affected. Waterlogging can also predispose plants to infection by *M. phaseolina*.

Leaves on infected plants often wilt and die before any external lesions or discoloration is visible on the stem. However, in most cases the stems of wilted plants turn light tan and later dark brown, and when the bark is peeled away the inner stem will be orange-brown rather than the normal white to light-green colour.

Once the plant has died the external surface of the lower stem and taproot turns a charcoal colour. Internally there is often a grey staining pattern. Affected stems contain minute, black fungal bodies called microsclerotia, which can survive in the soil and crop trash and spread on seed. *M. phaseolina* has a wide host range, including most summer crops and weeds. Evidence suggests that infection of soybean plants occur during the early seedling stages and remain latent until the plants are stressed.

To control the disease, irrigate regularly, rotate soybeans with winter cereal crops and control weeds.³



Figure 1: Charcoal rot. (Photo: Australian Oilseeds Federation)

² Australian Oilseeds Federation (2013), Better Soybeans manual http://www.australianoilseeds.com/soy_australia/Soybean_Production

³ Australian Oilseeds Federation (2013), Better Soybeans manual http://www.australianoilseeds.com/soy_australia/Soybean_Production

9.1.4 *Phytophthora stem and root rot (Phytophthora sojae)*

Phytophthora root rot is a threat in irrigated systems, especially in southern NSW and northern Victoria. While there are many strains, good resistance to the strains known to be important has been incorporated into the latest varieties.⁴

This pathogen attacks soybean plants at all stages of growth, causing pre-emergence and post-emergence damping off and later wilting and death of older plants.

As *P. sojae* needs free water for spore development, movement and infection, diseased plants will usually occur in patches in poorly drained areas of the paddock and at the tail ditch end of irrigated crops. Infected plants may be later found throughout the field. On older plants the first symptom is wilting and interveinal chlorosis (yellowing) of the lower leaves. However, the diagnostic feature of this disease is a sunken, brown-reddish lesion advancing up the stem, with a distinct margin between the lesion and the green, healthy part of the stem.



Figure 2: Charcoal rot symptoms in the stem. (Photo: Australian Oilseeds Federation)

Infected lateral and branch roots are almost completely destroyed and infested taproots turn dark-brown. Infected plants usually die and withered leaves can remain on the plant for a week or more.



Figure 3: *Phytophthora* damage. (Photo: Australian Oilseeds Federation)

⁴ GRDC (2014) Australian soybeans come of age: <http://www.grdc.com.au/Media-Centre/Ground-Cover/Ground-Cover-Issue-113-NovDec-2014/Australian-soybeans-come-of-age>

Phytophthora root rot is found throughout all growing regions, and is most severe on heavy, poorly drained soils where soybeans have been grown continuously for several years. As the fungus can survive for many years as thick-walled oospores in soil, avoid planting susceptible varieties where there is a history of the disease in the paddock. The fungus is specific to soybeans and does not occur in other crops or weeds.

Five (5) races (strains, pathotypes) of *P. sojae* have been identified in Australia, with races 1 and 15 being dominant in Queensland and northern NSW and races 4 and 25 dominant in southern Australia. Current varieties have good levels of resistance to the main races – refer to DAF Qld and NSW DPI websites for up-to-date information on varietal resistance.

Another species of Phytophthora, *P. macrochlamydospora* has been found on soybeans only in the coastal growing areas of northern NSW. It causes a root rot without the presence of the typical stem lesion caused by *P. sojae*. Local native legumes are susceptible to the pathogen so it appears that this fungus is indigenous to Australia. The disease generally appears after a crop has been waterlogged or flooded. There is no known resistance to *P. macrochlamydospora*.⁵

9.1.5 Sclerotinia stem rot (*Sclerotinia sclerotiorum*)

Plants infested with sclerotinia develop a white, cottony growth on the stems followed by the formation of large, black sclerotia (resting bodies of the fungus). The infected part of the stem turns soft and white and the plant parts above the lesion dies. Sclerotes may also form in the pith where they are more uniform and cylindrical in shape. The first sign of the disease is dead leaves at the top of individual plants scattered though the crop.



Figure 4: *Sclerotinia* stem rot showing large black sclerotes (fungal survival structures). (Photo: Australian Oilseeds Federation)

The disease often occurs where soybeans are grown following susceptible crops such as sunflower, navy beans, cotton, peanuts and crucifers. Many broadleaf weeds are also hosts of sclerotinia.

Cool, humid weather conditions, tall, dense crops and overhead spray irrigation during flowering favour the disease. Under these conditions sclerotes germinate to produce a

⁵ Australian Oilseeds Federation (2013), Better Soybeans manual http://www.australianoilseeds.com/soy_australia/Soybean_Production

small mushroom-like structure on which spores develop. These airborne spores firstly colonise dead flower petals and leaves and later stems and other aboveground tissues. Regularly inspect the lower canopy of plants after flowering for signs of the disease. No fungicides are currently registered for the control of sclerotinia stem rot.

Avoidance of infested fields and crop rotation are the best management options. Do not grow soybeans in paddocks known to be infested with sclerotinia for at least 4 years after the last affected crop and rotate with grass crops such as sorghum, maize and winter cereals.⁶

9.1.6 Sclerotium base rot (*Sclerotium rolfsii*)

This disease causes wilting and death usually on isolated plants of all ages, but in some situations plant losses can be significant. A brown lesion develops on stems at ground level and a white fan-like mat of fungal strands (mycelium) develops on the lesion and sometimes on the ground and plant residues around the affected stem. Round, brown sclerotia 1-2 mm in diameter usually form in the fungal mat. The disease occurs during hot (25-35°C) weather often after drought conditions and when soil moisture levels are high. Therefore the disease is more common in areas such as central Queensland.

Planting into partly decomposed plant residues increases the risk from infection. The fungus survives as sclerotes or in infected plant residues. Burying infected residue, minimising in-crop machinery movement and rotations with winter cereals will help to minimise the disease.⁷



Figure 5: *Sclerotium base rot showing light and dark brown sclerotes and white fungal hyphae.* (Photo S. Allen CSD) (Photo: Australian Oilseeds Federation)

9.1.7 Phomopsis pod and stem blight and seed decay (several *Phomopsis/Diaportha* species)

Phomopsis pod and stem blight and seed decay tend to occur more commonly in coastal areas of Queensland and northern New South Wales. Infected plants usually do not display any symptoms of infection until plant death. A slightly sunken brown lesion may develop at the base of a branch or a leaf stalk. After plant death, small black fruiting bodies (pycnidia) develop on stems and pods. On stems, the fruiting bodies tend to develop in rows, whilst on pods the pycnidia are scattered.

Seeds affected by phomopsis are usually discoloured and covered by a white cottony fungal growth. Other symptoms include shrivelling, cracking and splitting of the seed coat. Affected seeds have low vigour and seedlings growing from such seeds usually die.

⁶ Australian Oilseeds Federation (2013), Better Soybeans manual http://www.australianoilseeds.com/soy_australia/Soybean_Production

⁷ Australian Oilseeds Federation (2013), Better Soybeans manual http://www.australianoilseeds.com/soy_australia/Soybean_Production

Infected crop residues and seed are the main modes of survival from season to season. Spores, which ooze out of the fruiting bodies, are spread from plant to plant by rain splash. Seed infection occurs during periods of prolonged rainfall during late pod formation. Delaying harvest after wet weather can lead to high infection levels.

Seed decay caused by phomopsis can be minimised by sowing disease free seed, selecting a weathering tolerant variety, timely harvesting and residue management.⁸



Figure 6: *Phomopsis* stem blight. (Photo: Australian Oilseeds Federation)

9.1.8 Rhizoctinia root rot (*Rhizoctonia solani*)

As well as causing seedling damping off, *R. solani* can also cause root rot in older plants. The first sign of infection is stunted plants, which usually occur in patches across the paddock. There is often a clear boundary between the stunted and healthy plants. The crown and tap roots of affected plants have a reddish brown discoloration, and the lateral roots are short and stubby. Disease outbreaks are favoured by heavy soils and rainfall followed by cool then warm conditions. Rhizoctonia root rot is most common in southern New South Wales and Victorian soybean crops.

The pathogen survives as sclerotia or resting mycelium and also has the ability to saprophytically colonise all types of plant residue. No Australian varieties have resistance to *R. solani*, so rotation out of infested paddocks is the only management option.⁹

9.1.9 Rust (*Phakopsora pachyrhizi*)

Soybean rust is present in most Australian soybean growing regions, and can infect the crop at any stage in its development although it is usually found late in the season. Rust typically occurs on coastal crops with an outbreak occurring every four to five years, but rust has been recorded in inland areas in mild, wet summers. Under ideal conditions pod formation and seed size are affected, often reducing yields by 10% or more.

The disease is favoured by showery weather. Once infected, plants will develop small yellow lesions on the upper-leaf surface. Light red pustules develop on the underside of leaves and release wind-borne spores. Initially, the lesions will usually appear on the

⁸ Australian Oilseeds Federation (2013), Better Soybeans manual http://www.australianoilseeds.com/soy_australia/Soybean_Production

⁹ Australian Oilseeds Federation (2013), Better Soybeans manual http://www.australianoilseeds.com/soy_australia/Soybean_Production

lower leaves, but may later spread rapidly over the entire plant, leading to yellowing and premature defoliation.

In Australia, soybean rust also infects some native glycine species. The pathogen is an obligate parasite and requires a living host for survival, so between cropping seasons it survives on volunteer soybean plants or alternative hosts.

Unfortunately, the current commercial varieties have little resistance to the rust pathogen. Although mancozeb is registered (as various products) for the control of rust, it is a protectant fungicide that is most effective when applied before the disease appears. Several applications should be made, 14 days apart. Overseas, systemic fungicides are applied at the first appearance of the disease. In most years there is little advantage in applying these fungicides during the crop's vegetative stage unless rust levels are high. Early pod formation is the most critical time for systemic fungicide application if rust is present, and a follow-up spray 2 weeks later is recommended. These systemic fungicides are not to be applied after the R5 stage due to residue concerns. Check the APVMA website for fungicides under permit for rust control.¹⁰



Figure 7: Soybean rust, lower leaf surface (left), upper leaf surface (right). (Photo: Australian Oilseeds Federation).

9.1.10 Downy mildew (*Peronospora manshurica*)

Downy mildew appears on the upper surfaces of young leaves as pale green-light yellow spots expanding to light-dark yellow lesions of varying shape. On the lower leaf surfaces, a white downy growth appears opposite the discoloured lesions and under severe conditions premature leaf drop may occur. While this disease is often widespread during mild, wet seasons, yield loss is insignificant. However, the disease can reduce the quality of the harvested seed due to a white crust (consisting of oospores) on the seed coat. The pathogen survives as oospores in infected leaves and on seed.

The resistance of current varieties is not well known due to the sporadic nature of the disease. New South Wales coastal varieties may be more resistant than other varieties because the disease is more common in this region, but the low incidence and relatively nominal impact of the disease on yield, make this a low priority when selecting varieties.

Do not to retain or use planting seed from downy mildew-infected crops as it can reduce germination and establishment.¹¹

¹⁰ Australian Oilseeds Federation (2013), Better Soybeans manual http://www.australianoilseeds.com/soy_australia/Soybean_Production

¹¹ Australian Oilseeds Federation (2013), Better Soybeans manual http://www.australianoilseeds.com/soy_australia/Soybean_Production

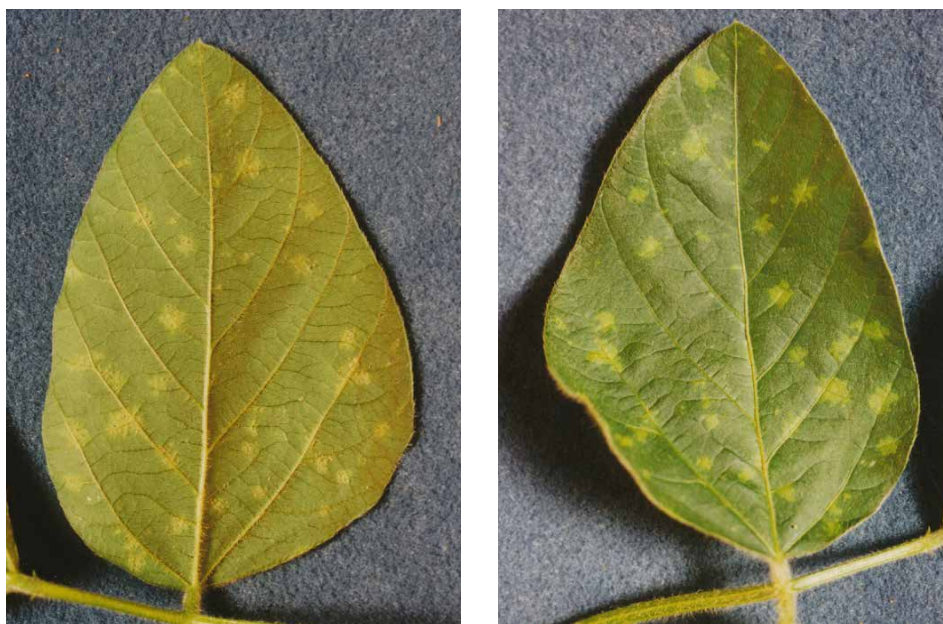

Figure 8: Downy mildew, lower leaf surface (left), upper leaf surface (right). (Photo: Australian Oilseeds Federation)

9.1.11 Purple seed stain (*Cercospora kikuchii*)

Purple seed stain is an occasional and minor problem in most Australian varieties, with the incidence depending on weather conditions during crop growth.¹²

Seeds affected by *C. kikuchii* have a diffuse purple discoloration of the seed coat, which may extend of part or all of the seed coat. This disease is favoured by warm wet weather during which airborne spores developed on infested stubble infect stems, leaves and pods. *C. kikuchii* does not reduce yields, and is not considered detrimental to the quality of beans as the purple colour disappears upon heating. Avoid using infected seed for planting as it can reduce establishment and crop vigour.¹³

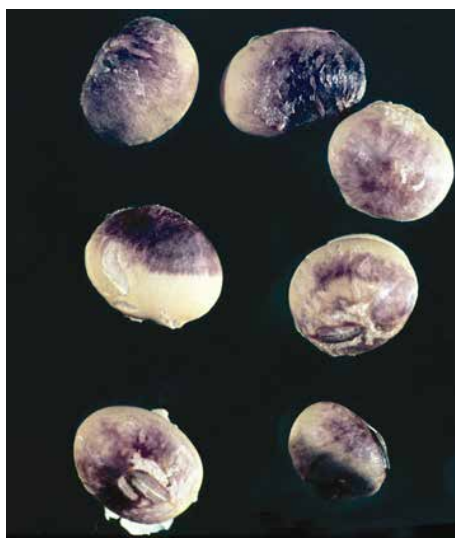

Figure 9: Purple seed stain. (Photo: Australian Oilseeds Federation)

¹² M Ryley, Effects of some diseases on the quality of culinary soybean seed: http://www.australianoilseeds.com/_data/assets/file/0004/1201/Malcolm_Ryley-Effects_of_some_diseases_on_the_quality_of_culinary_soybean_seed.pdf

¹³ Australian Oilseeds Federation (2013), Better Soybeans manual http://www.australianoilseeds.com/soy_australia/Soybean_Production

9.1.12 Powdery mildew (*Erysiphe diffusa*)

Powdery mildew is a rare disease, although it was found in many crops in southern Queensland and northern New South Wales in the mild and wet 2012 season. White, powdery patches occur on both of the lower leaves, and the disease can later spread onto younger leaves. Spores, which develop on the white powdery growth, spread many kilometres in the wind. The soybean powdery mildew pathogen probably survives from season to season on volunteer soybean plants and perhaps on alternative hosts, but little is known about the host range of this fungus. Based on observations in 2012 significant yield losses can occur under ideal conditions. Evidence suggests that some Australian soybean varieties are more susceptible to *Erysiphe diffusa* than others.¹⁴

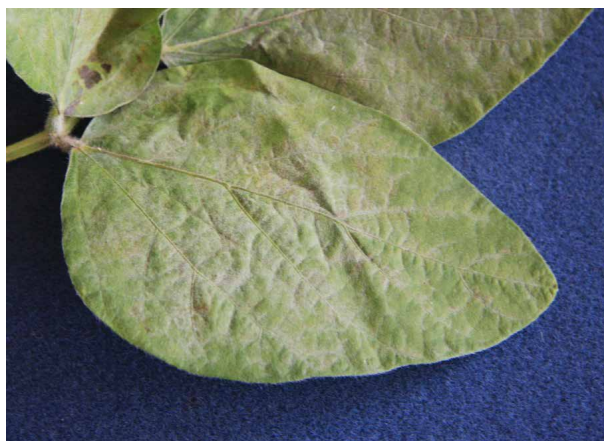

Figure 10: Powdery mildew. (Photo: Australian Oilseeds Federation)

9.1.13 Bacterial diseases

The pathogens responsible for the major bacterial diseases of soybean do not have other hosts so they survive on un-decomposed crop residues, volunteer soybean plants and infected seed. Once established in a crop, the bacteria can rapidly spread during wet, windy weather. Seed infection can occur during harvesting of a diseased crop. Bacterial diseases include:¹⁵

- bacterial blight
- bacterial pustule
- wildfire

9.1.14 Bacterial blight (*Pseudomonas syringae* pv. *glycinea*)

Bacterial blight causes brown, angular spots, which join to form dark-brown, dead areas with yellow margins on the leaves. These areas frequently tear, giving the leaves a ragged appearance. Spots also occur on stems.

While bacterial blight is a common disease in most crops it is never severe (<1% of the leaf affected), causing little or no economic loss. Management strategies involve using high-quality seed, encouraging the breakdown of crop residue and destroying volunteer plants.¹⁶

¹⁴ Australian Oilseeds Federation (2013), Better Soybeans manual http://www.australianoilseeds.com/soy_australia/Soybean_Production

¹⁵ Australian Oilseeds Federation (2013), Better Soybeans manual http://www.australianoilseeds.com/soy_australia/Soybean_Production

¹⁶ Australian Oilseeds Federation (2013), Better Soybeans manual http://www.australianoilseeds.com/soy_australia/Soybean_Production



Figure 11: Bacterial blight. (Photo: Australian Oilseeds Federation)

9.1.15 Bacterial pustule (*Xanthomonas axonopodis* pv. *glycines*)

This disease causes small, yellow spots with light-brown centres on leaves. A tan coloured, raised pustule develops at the centre of each spot especially on the lower surface. The raised pustule collapses with age leaving a brown spot with a bright-yellow margin. Pustules also occur on stems.

It is difficult to distinguish this disease from rust when both diseases are at an early stage of development.

While not generally regarded as an important disease, it can be a problem in coastal regions, especially under wetter, more humid seasonal conditions with extended cloud cover. Disease resistance developed through the plant breeding program and field screening is the only practical means of control.¹⁷



Figure 12: Bacterial pustule. (Photo: Australian Oilseeds Federation)

¹⁷ Australian Oilseeds Federation (2013), Better Soybeans manual http://www.australianoilseeds.com/soy_australia/Soybean_Production

9.1.16 Wildfire (*Pseudomonas syringae* pv. *tabaci*)

Wildfire is distinguished by brown, dead areas of variable size and shape surrounded by wide, yellow haloes with very distinct margins on plant leaves. The spots may join as the disease progresses. Affected leaves fall readily.

Wildfire generally occurs only after bacterial pustule infection. A bacterial pustule, or a remnant of one, is usually found near the centre of each wildfire spot. Disease resistance developed through the plant breeding program and field screening is the only practical means of control. Wildfire is a rare disease.¹⁸

9.1.17 Big bud (also called witch's broom and little leaf)



Figure 13: Big bud, also called witch's broom and little leaf. (Photo: Australian Oilseeds Federation)

Phytoplasmas are responsible for this disease, which causes multiple branching, replacement of flower petals with short leafy shoots and small leaflets. Plants affected by phytoplasmas are found at a very low incidence in most soybean crops where they tend to be more common at the edges of crops. Weeds are the main alternative crops and the phytoplasma particles are spread from infected weeds to soybean plants by leafhoppers. The low frequency of phytoplasma infection does not warrant the use of insecticides to manage the insect vectors. Control of weeds around the paddock will reduce the risk of phytoplasma infection.¹⁹

9.1.18 Viruses

The two main viruses that affect soybeans in Australia are soybean mosaic virus (SMV) and peanut mottle virus (PMV), but neither is economically important. SMV causes a light green-dark green mosaic, vein clearing, rugosity and stunting of leaves, with symptoms being reduced above 25°C and masked above 30°C. On varieties with seeds that have brown or black hila, infected seeds will display brown or black streaks extending from the hilum. Symptoms of PMV on leaves are similar to those caused by SMV, but line or ring patterns may appear on leaves. PMV is more common when soybean crops are grown near peanuts. The low occurrence and incidence of these

¹⁸ Australian Oilseeds Federation (2013), Better Soybeans manual http://www.australianoilseeds.com/soy_australia/Soybean_Production

¹⁹ Australian Oilseeds Federation (2013), Better Soybeans manual http://www.australianoilseeds.com/soy_australia/Soybean_Production

aphid borne viruses means that management through insect control or other practices is not needed.²⁰

9.1.19 Nematodes

Root knot nematodes (RKN, caused by *Meloidogyne* species) and root lesion nematodes (RLN, caused by *Pratylenchus* species) have wide host ranges, on soybeans causing stunting, yellowing, poor growth and wilting during hot, dry weather. The diagnostic feature of root knot nematode infection is the presence of galls or knots of various sizes on the roots of affected plants. Root lesion nematodes cause dark lesions on lateral roots. Root knot nematodes are more severe on light sandy soil, whereas RLNs are more common in heavier soils. Different species of *Meloidogyne* and *Pratylenchus* have different host ranges, so knowledge of the species affecting soybean crops in a particular paddock is needed before effective rotations can be developed.²¹

9.1.20 Sunburn

Sunburn damage results in small, interveinal brick red spots on the underside of leaves but in more severe cases the entire leaf surface may have a diffuse reddish colour. Sometimes the spots develop dead centres and can be colonised by saprophytic fungi and bacteria.²²

9.2 Varietal resistance or tolerance

Table 1: Variety tolerances²³

	Colour			Tolerance to				
	Flower	pod hair	hilum	Manganese	Weathering ^A (0–10)	Phytophthora ^B		Sclerotinia ^B
						race 1	race 15	
Cowrie	white	grey	clear	++	7	✓	×	unknown
Soya 791	white	grey	buff	0	7	✓	×	+
Zeus	purple	brown	dark	++	10	✓	×	+++
Manta	purple	brown	dark	++	8	✓	×	+++
Poseidon	purple	brown	dark	++	8	✓	✓	+
Surf	purple	grey	clear	unknown	6.5	✓	✓	unknown
A6785	white	grey	buff	unknown	7.5	✓	✓	unknown
Dragon	white	grey	buff	unknown	0	✓	✓	unknown
Warrigal	white	grey	clear	0	2.5	✓	✓	0

9.3 Conditions favouring development

To reduce disease problems, avoid planting soybeans after other legumes or sunflowers. New varieties have genetic resistance to phytophthora, the main disease of soybean.

²⁰ Australian Oilseeds Federation (2013), Better Soybeans manual http://www.australianoilseeds.com/soy_australia/Soybean_Production

²¹ Australian Oilseeds Federation (2013), Better Soybeans manual http://www.australianoilseeds.com/soy_australia/Soybean_Production

²² Australian Oilseeds Federation (2013), Better Soybeans manual http://www.australianoilseeds.com/soy_australia/Soybean_Production

²³ NSW DPI http://www.australianoilseeds.com/_data/assets/pdf_file/0020/7670/Soybean_North_Coast_NSW_Planting_Guide.pdf

i More information

<http://grdc.com.au/Research-and-Development/GRDC-Update-Papers/2015/07/Disease-control-in-summer-crops-and-management-strategies-to-minimise-financial-losses>

9.4 Management of disease

Integrated disease management (IDM) involves the selection and application of a range of control measures that minimises crop losses, maximises returns and ideally makes minimal impact on the environment, flora and fauna.

Most plants are immune or resistant to almost all plant pathogens. This immunity is normal. However, some pathogens have the ability to infect particular plant species and cause disease. When this occurs, the host is considered susceptible to the pathogen and the pathogen is described as being virulent on that host.

When a virulent pathogen comes into contact with a susceptible host and the environmental conditions are suitable, a disease develops in the host and the characteristic symptoms of that disease are produced.

The disease triangle depicts the interactions between host, pathogen and the environment, the latter having the major impact on the severity of the disease outbreak. Although a pathogen may be present, if the weather conditions are not conducive the disease will not develop on a host.²⁴

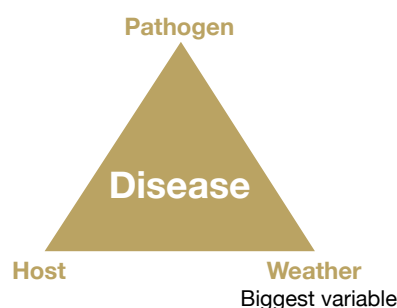

Figure 14: Interaction between host, pathogen and weather determines disease severity.

9.4.1 Integrated Disease Management

Effective Integrated Disease Management (IDM) should be on the whole farm level. Basic strategies should be implemented regardless of whether or not a significant disease exists. Prevention and minimisation of the disease risk is the key to effective IDM.

Best practice strategies

- Staff training: educate staff on possible disease incursions and encourage proactive feedback on unusual symptoms and plant growth habits.
- Farm hygiene: minimise movement of pathogens between paddocks and between farms. Many pathogens can easily be transferred on tyres, machinery, boots or plant matter such as hay.
- Developing a sound crop rotation strategy: repeated plantings of soybeans will lead to the build up of soil borne pathogens. A good understanding of the host range of major pathogens of soybean is vital.
- Paddock selection: a thorough knowledge of the disease history of paddocks and of the biology of major soybean pathogens will help in paddock selection.
- Management of crop residues and weeds: to minimise carryover and build-up of pathogens, for example nearly all weeds host *Sclerotinia*.
- High quality seed: use high germination and vigour, disease-free seed to ensure rapid germination and to reduce the risk of seedling diseases. A fungicide seed dressing will also help to minimize risk.

²⁴ Australian Oilseeds Federation (2013), Better Soybeans manual http://www.australianoilseeds.com/soy_australia/Soybean_Production

- Resistant varieties: use whenever available. Source information on the resistances of varieties to pathogens and select a variety with the highest resistance to the major disease(s) in your area.
- Crop nutrition: a healthy crop is more able to express its resistance/tolerance than a crop under stress.
- Disease awareness: ensure you have up-to-date information on the incidence and biology of current disease outbreaks and whether or not the incidence/severity of outbreaks is increasing each season.
- Regular crop monitoring: regularly check your crops for anything out of the ordinary. Walk through the crop in a W pattern – this will minimise the risk of missing disease hotspots and allow you to gauge any possible edge effects or disease gradients.
- Foliar fungicides: spray registered/permitted fungicides in a timely manner using good application techniques to minimise damage from foliar fungal pathogens.²⁵

9.4.2 Risk Assessment

Assessment of disease risk relies on a grower's/adviser's knowledge of paddock history, confidence in forecasts of the weather and possible price, willingness to educate themselves about pathogen biology, and their tolerance for accepting risk.

Some disease management decisions can be made pre-planting.

Other disease management risk factors involve both pre- and post-planting decisions.

Each crop/disease risk analysis will:

Identify the factors that determine risk

- Pathogen: Pathogenicity, survival, transmission and infection mechanism, availability of control measures, is it widespread or sporadic?
- Host: vulnerability, varietal reactions, availability of resistant varieties, host range of major diseases and seed dressings.
- Agronomy: row spacing, soil conditions, cultural practices, plant residues, nutritional interactions, irrigation or dryland, herbicides used, time of planting.
- Weather: weather forecasts including possible temperature variation, rainfall and relative humidity. Climatic conditions affect both plant growth and the pathogen's biological activities. A stressed plant is more vulnerable to disease outbreaks.
- Risk Management: access levels of risk, contemplate ease of implementing management plan, assess cost of implementation, and assess value of possible returns over known risk factors.

Analyse specific known risk factors

- Pathogen: virulence level against varieties, level of inoculums in air/soil/seed, known paddock history, alternative weed hosts for either pathogen or its vector.
- Host: susceptibility to pathogen, stress reactions to herbicides, nutritional disorders.
- Agronomy: weather outlook, time of planting, effectiveness of cultural control methods prior to planting, airborne inoculums levels built up during season.
- Weather: water storage in profile, long term forecast for rain or abnormal conditions, potential for water stress during growing season.
- Risk management: ensure strategy is flexible and adjust as necessary.

²⁵ Australian Oilseeds Federation (2013), Better Soybeans manual http://www.australianoilseeds.com/soy_australia/Soybean_Production

Acknowledge your own acceptable risk level

- Low: crop failure would impact seriously on the farm economic situation, not necessarily a good time to try new and untried cropping options.
- High: a risk of substantial losses if potential returns/financial rewards are high, a failure in the rotation would not unduly affect the potential earning capacity of the farm.

Providing Accurate Diagnosis

Not so easy: diagnosing a plant disorder is not always quick or easy. Unlike insect pests, which are relatively easy to identify, the accurate diagnosis of plant diseases requires patience and at times, a microscope.

Different pathogens can produce similar and confusing symptoms, so the diagnostician needs to keep an open mind until all aspects of the host/pathogen interaction are considered. Several casual agents could be involved in the expression of symptoms.

However, some pathogens cause characteristic symptoms and with experience, a network of other specialists and suitable reference materials, a quick diagnosis can be achieved. There is no substitute for having hands-on approach to soybean disease management – each season will bring its own unique mysteries to solve.

- Be observant: note the range of symptoms you observe in the crop.

Make a list: list all possible culprits as you observe symptoms. Most will be discounted as you progress through your diagnostic analysis.

Study healthy plants: Compare healthy plants with affected plants to understand the effects that a pathogen has had on the plants.

- Check all parts of the plant: symptoms on leaves can be the result of infection by foliar, root or vascular pathogens.
- Are affected plants scattered across the crop, in groups or at the edge of a crop?
- Do the affected plants follow the row or are they randomly distributed across the paddock? Wilted plants along a row can be the result of mechanical damage during cultivation methods. Plants randomly distributed across the paddock are more likely to indicate a soil borne pathogen.
- Are the symptoms widespread across the paddock – if so, are there any abiotic (non-living) reasons why the crop would be uniformly affected. Was a particular herbicide used in the previous rotation that may not have broken down quickly as expected due to weather conditions: was the appropriate rate of fertiliser applied or could the symptoms indicate a nutritional disorder; was a chemical applied off-label or in a mix that caused phytotoxicity; could spray drift be a factor?
- Widespread symptoms can indicate abiotic factors such as
 - Soil conditions – deficiencies, toxicities, pH, excess salt in irrigation water
 - Adverse climatic conditions – hail, drought, flooding, cold or heatwaves
 - Toxic chemical – inappropriate chemical usage, experimental products, growth regulators
 - Human error
- Is there a disease gradient into the paddock – if so, has a neighbouring paddock or laneway had a chemical applied that may be phytotoxic to your crop or is a weed growing alongside your crop that may be a host for vector for the disease.
- Pathogens take time to build up in a crop – regular monitoring for both insects, diseases and weed hosts will decrease the chances of unpleasant surprises later in the season.
- Check for distinctive visual or odour symptoms – is there ooze or an unpleasant odour?
- Is the problem restricted to this paddock? Or is it across several varieties? Are the plants at different growth stages? Did the previous crop exhibit any symptoms?

Geographical distribution – some pathogens are more suited to certain growing regions. For example rust is virulent particularly on coastal soybeans and legumes.

Know your pathogens – understanding the life cycles of the pathogens can help with obtaining an accurate diagnosis.

- Check watering schedules – herbicides can accumulate in tail ditches of paddocks – is there a gradient of symptoms up from the end of the paddock? Could these plants be waterlogged? Water logging can lead to nutritional disorders and increase plant susceptibility to disease.
- Symptom variability – can lead to improper diagnosis. Environmental conditions, varietal differences and multiple pathogens infecting the one plant can cause symptom variability. Inspect a number of plants and note common irregularities. If in doubt, get a second opinion.
- Check soil compaction – compacted soil and plough pans will often lead to “right angle root syndrome”. Roots are unable to penetrate through the impacted layers resulting in poor root development, which can lead to water stress, nutritional disorders and herbicide damage.

Ask questions – the more information you can gather about a site and affected crop, the better – crop rotational history, variety, herbicide, insecticide and fungicide applications for both this crop and the previous crops, fertiliser applications, chemical applications in nearby crops.

Be aware – many disease outbreaks occur in tandem with outbreaks in other cropping areas. Be aware of changes in environmental conditions, which could lead to potential disease outbreaks.

Ask for help – do not hesitate to contact other specialists. Working together will enhance the chances of an accurate diagnosis and will also improve your knowledge of potential diseases.²⁶

9.4.3 Tools of the trade

Reference materials: even specialists who work with plant diseases on a daily basis need reference material. Important reference materials include the GRDC Mungbean and Soybean Disorders: The UteGuide, Compendium of Soybean Diseases 4th edition (APS Press), and the internet.

Hand lens, magnifiers: essential when looking for fruiting bodies in lesions; small digital magnifiers such as Dinolite® are very useful.

Knife or secateurs: invaluable for checking damage to the interior of roots and stems.

Camera: record a range of symptoms and send to a specialist. Sometimes, a few good images is enough for the diagnostician to make a tentative diagnosis.

Paper and plastic bags: place samples in a plastic bag and keep them cool until lab testing can be completed. If the sample has to be posted, ensure overnight delivery or the sample may rot in a plastic bag. If in doubt, use both plastic and paper bags. Send plants displaying a range of symptoms and also include one or two healthy plants.

Esky and cooler bricks: preferably, carry an esky and cooler bricks to keep samples cool before they are sent to a specialist.

GPS: provides an accurate location for data, monitoring outbreaks and disease spread.

Felt pens: ideal for labelling plastic and/or paper bags.

More information

[Australian Oilseed Federation, Queensland Grower Guidelines](#)

[DAFF Disease](#)

[NSW DPI Soybean: Norther Coast Planting Guide](#)

[NSW Summer crop production guide 2014](#)

[GRDC Soybean Leaf Rust Fact Sheet](#)

[Crop Focus, Glyphosate and Fungicide Application Timing in Soybean](#)

²⁶ Australian Oilseeds Federation (2013), Better Soybeans manual http://www.australianoilseeds.com/soy-australia/Soybean_Production

Clipboard and sample information sheets: use a clipboard or notebook to record all the information so it can be recalled and reviewed at a later date if required. An example of a disease information sheet is provided at the end of this module.²⁷

A

1

2

3

4

5

6

7

8

9

10

11

12

13

14

15

16

17

18

²⁷ Australian Oilseeds Federation (2013), Better Soybeans manual http://www.australianoilseeds.com/soy_australia/Soybean_Production

SECTION 10

Plant growth regulators and canopy management

Not applicable for this crop.

A

1

2

3

4

5

6

7

8

9

10

11

12

13

14

15

16

17

18

SECTION 11

Crop desiccation/spray out

More information

[GRDC Fact Sheet Pre Harvest herbicide use](#)

Desiccation prepares the crop for harvesting by removing moisture from plants and late maturing areas of the paddock.

Desiccation is an aid to a timely harvest, particularly where uneven ripening occurs across a paddock. It enables a timely harvest to avoid weather damage. Application timing is based on the crop when the grain is 75% to 90% mature, to avoid reducing the quality of the harvested grain.¹

Growers aiming to maintain or improve grain quality, or simply speed up the harvest, may wish to desiccate the crop. Some crops are slow to drop leaves and some localities are prone to wet weather at harvest, which reduces yield through shattering or weathering damage.

Excessive weed growth can delay harvest and cause green staining on culinary beans during thrashing.

Two chemicals are registered for desiccation of soybean crops, namely diquat (Reglone®) and glyphosate (not all product labels are registered for this use and not for seed soybeans). Reglone® is generally the preferred product to gain maximum advantage in dry down and quicker responses on weed growth. Generally, experience has shown that using the higher recommended rates of Reglone provides the most efficient results.

Beware of potential drift damage to neighbouring crops. Damage is usually only of a cosmetic nature but it is a significant concern for vegetable crops.²

Crop desiccants/harvest aids like Reglone® or Weedmaster Argo/DST are commonly needed in coastal areas and other seasonally humid areas to manage weeds, hasten leaf drop and facilitate uniform harvest conditions. Weigh up the costs of a desiccating operation on crop damage and losses due to running down some of the crop. Speak to an agronomist experienced in desiccation of soybeans when deciding when and how to desiccate.³

The application of herbicides late in the season to prevent weeds setting seed or to desiccate crops must be carried out with caution and in line with herbicide label recommendations. It is essential to check if these practices are acceptable to buyers, as in some situations markets have extremely low or even zero tolerance to some pesticide and herbicide residues.

There are three reasons to apply non-selective herbicides late in the season: just prior to harvest to manage late season weeds; in-crop spray topping of annual ryegrass to prevent seed set; and for pre-harvest desiccation of the crop to accelerate or even-up ripening to assist with harvest.

¹ Pulse Australia, APB desiccation and croptopping: <http://www.pulseaus.com.au/growing-pulses/publications/desiccation-and-croptopping>

² QLD DAFF Harvest and Drying <https://www.daf.qld.gov.au/plants/field-crops-and-pastures/broadacre-field-crops/soybeans/harvesting-and-drying>

³ Australian Oilseeds Federation (2013), Better Soybeans manual http://www.australianoilseeds.com/soy-australia/Soybean_Production

Glyphosate, diquat and paraquat are registered for late season uses in many pulse crops (Table 1). Pulse registrations and withholding periods vary between product labels.⁴

Table 1: Product registrations for pre-harvest weed control and desiccation vary by crop type.

Always check product labels (Note: paraquat/diquat products, for example spray.seed® are not registered for pre-harvest weed control or desiccation). (Source: GRDC, <http://www.grdc.com.au/GRDC-FS-PreHarvestHerbicide>)

Crop	Paraquat	Diquat	Glyphosate
Wheat	<p>Paraquat is not registered for:</p> <ul style="list-style-type: none"> in-crop spray topping; pre-harvest crop desiccation; pre-harvest weed control. <p>DO NOT USE PARAQUAT PRODUCTS FOR THESE USE PATTERNS</p> <p>These use patterns are unregistered.</p>	<p>Pre-harvest weed control (all states): Spray as soon as the crop is mature and ready for harvesting. Under wet spring conditions crops can periodically become infested with weeds which seriously interfere with harvest operations. Diquat will control these weeds allowing for efficient harvest.</p> <p>WHP: NOT required when used as directed.</p>	<p>Not all glyphosate formulations are registered for this use. Apply to mature crop from late dough stage (28 per cent moisture) onwards. The higher rate will be required when crops are heavy and leaf shading effects may occur.</p> <p>DO NOT use on crops intended for seed or sprouting. Where wheat is grown in rotation with any herbicide-tolerant crop, management should be consistent with implementation of any management plan for herbicide-tolerant crops.</p> <p>WHP: DO NOT harvest within 7 days of application.</p> <p>Only weedmaster®DST® can now be applied at higher use rates in wheat with a 5-day harvest withholding period.</p>
Barley	<p>Paraquat is not registered for:</p> <ul style="list-style-type: none"> in-crop spray topping; pre-harvest crop desiccation; pre-harvest weed control. <p>DO NOT USE PARAQUAT PRODUCTS FOR THESE USE PATTERNS</p> <p>These use patterns are unregistered.</p>	<p>Winter cereals – pre-harvest weed control (all states): Spray as soon as the crop is mature and ready for harvesting. Under wet spring conditions crops can periodically become infested with weeds which seriously interfere with harvest operations. Diquat will control these weeds allowing for efficient harvest.</p> <p>WHP: NOT required when used as directed.</p>	<p>Glyphosate is not registered for:</p> <ul style="list-style-type: none"> in-crop spray topping; pre-harvest crop desiccation; pre-harvest weed control. <p>DO NOT USE GLYPHOSATE PRODUCTS FOR THESE USE PATTERNS</p> <p>These use patterns are unregistered.</p>
Canola	<p>Paraquat is not registered for:</p> <ul style="list-style-type: none"> in-crop spray topping; pre-harvest crop desiccation; under-the-cutter-bar spraying during swathing or windrowing activities; pre-harvest weed control; spraying over the top of swaths or windrows <p>DO NOT USE PARAQUAT PRODUCTS FOR THESE USE PATTERNS</p> <p>These use patterns are unregistered.</p>	<p>Pre-harvest crop desiccation (all states):</p> <p>Spray when 70 per cent of the pods are yellow and the seeds are brown or bluish and pliable. Canola ripens unevenly and is prone to pod shatter and seed loss. Direct harvest four to seven days after spraying.</p> <p>WHP: DO NOT harvest for at least 4 days after application.</p>	<p>Only weedmaster®DST® is registered for pre-harvest use in canola.</p> <p>Apply to mature standing crop from early senescence (minimum of 20% seed colour change to a dark brown/black colour from within the crop) prior to windrowing or direct harvest. Use the higher rate when crops or weeds are dense and/or where faster desiccation is required.</p> <p>DO NOT use on crops intended for seed</p> <p>DO NOT harvest for 5 days after application to standing crops DO NOT overspray windrows</p> <p>DO NOT apply to standing crops and again at the time of windrowing</p> <p>Refer to the complete weedmaster®DST® label and critical comments section.</p>

⁴ GRDC (2015) Preharvest Herbicide Use fact sheet: <http://www.grdc.com.au/GRDC-FS-PreHarvestHerbicide>

Crop	Paraquat	Diquat	Glyphosate
Chickpeas Faba beans Field peas Lentils	Spray topping to reduce seed set – annual ryegrass (all states).	Pre-harvest crop desiccation (all states):	Not all glyphosate formulations are registered for these uses.
Pigeon peas+ Lupins@ Vetch#	Chickpeas/Faba beans/Field peas/Lentils/Lupins/ Vetch: Spray the crop when the ryegrass is at the optimum stage, that is when the last ryegrass seed heads at the bottom of the plant have emerged and the majority are at or just past flowering (with anthers present or glumes open) but before haying off is evident – usually October to November.	Dry beans/Dry peas/Pigeon peas/ Lentils/Chickpeas/Faba beans/ Lupins/ Soybeans/Mungbeans: Mungbeans: Apply when 80 to 90% of pods are black or brown. Soybeans: Spray when 80% of the pods are yellow-brown and the seeds are ripe - yellow and pliable.	Field peas/Faba beans: Pre-harvest application to reduce viable seed set of annual ryegrass. Adzuki beans/Chickpeas/Cowpeas/Faba beans/Field peas/ Lentils/Mungbeans/ Soybeans: Pre-harvest application to desiccate a crop as a harvest aid and weed control – annual weeds.
Adzuki beans^ Cowpeas^ Mungbeans~ Soybeans~	Use of the higher rate in these crops is usually more reliable and gives a greater reduction in seed set. Reduction in crop yield may occur especially if the crop is less advanced relative to the ryegrass; that is, if crops have a majority of green immature pods. The higher rate may also increase any yield reduction. In practice crop losses in excess of 25 per cent may occur. WHP: DO NOT harvest for 7 days after application.	Helps overcome slow and uneven ripening and weed problems at harvest. WHP: NOT required for dry beans, dry peas, mungbeans when used as directed. Lentils/Chickpeas/Faba beans: DO NOT harvest for 2 days after application. Pigeon peas, Soybeans: DO NOT harvest for 4 days after application.	Chickpeas: Glyphosate + metsulfuron tank mix for pre- harvest application as harvest aid and weed control – annual weeds. WHP: DO NOT harvest within 7 days of application. Refer to label for specific timings. DO NOT use on crops intended for seed or sprouting.

Paraquat only ^ Glyphosate only + Diquat only ~ glyphosate and diquat only
 @ Paraquat products and diquat only
 WHP withholding period
 ® Registered trademark

Growers should consider the following prior to the selection and application of desiccant products:

- The advantages of using a harvest aid product include potentially better harvested seed quality, earlier harvest and/or increase harvesting efficiency. However, an improvement in overall yield potential is not an expectation.
- Pre-harvest herbicides do not speed up maturity, or make soybean seed dry down faster; they only serve to drop remaining leaves and dry out green material. A harvest aid may facilitate the drying of pods, making them easier to harvest.
- Desiccants can reduce green vegetation, but do not help remove excessive moisture from the seed. The addition of sodium chlorate to a desiccant can help to remove excessive moisture from green soybean tissue and/or seed, and provide control of weeds.
- If possible, avoid applying desiccant just before rain.
- Harvest the desiccated soybean crop as the label allows.⁵

⁵ AgKnowledge Spotlight, Soybean Harvest Aids: <http://www.aganytime.com/Documents/ArticlePDFs/Soybean%20Harvest%20Aids%20-%20Asgrow%20-%20Spotlight.pdf>

SECTION 12

Harvest

12.1 Harvesting

Harvesting of soybeans can be challenging regardless of the end-use for the beans; however this challenge becomes critical when ensuring high quality soybeans for the food grade market. With the right equipment and attention to detail it is possible to harvest the maximum amount of soybeans you have grown at the desired quality parameters.

The aim at harvest is to collect the maximum amount of soybeans at the optimal time (optimal throughput) with highest possible sample quality and purity, and with the lowest possible losses. Grower payment is conditional on tonnage delivered, moisture content, test weight and on seed sample quality and purity. Crop establishment and harvest management have a major effect on all of these.

In summary, harvesting soybeans to maximise yield and quality can be achieved by:

- Ensuring the best agronomic practices, compatible with harvest.
- Minimise pre harvest losses. For example, if desiccating the crop, timing is critical and using the widest boom possible to minimise seed loss from trafficking during the spray-out operation.
- Correct set up of the harvester.
- Minimise gathering losses.
- Minimise processor losses.
- Obtaining the best possible bin sample for quality and purity.¹



Figure 1: John Deere's STS 9760 with rotary threshing and separation shown in Iowa soybeans. The two types of combine harvesters in Australia—rotary and walker-or drum-type - are now all fully imported. Rotary separators dominate the modern market. John Deere no longer offers walker-types. In Australia we call such machines “headers” but the fact that these machines are all imported and take in more than just the crop heads may spell the eventual end of that name. (Photo: Australian Oilseeds Federation)

¹ Australian Oilseeds Federation (2013), Better Soybeans manual http://www.australianoilseeds.com/soy_australia/Soybean_Production



Figure 2: New Holland TC 5090 combine made in Belgium with five walkers shown. Walker separation is preferred in much of Europe where crop conditions are moister and farmers want the longer crop straw for baling. Lately there has been a move to hybrid machines in Europe for higher capacity at some sacrifice in straw quality. (Photo: Australian Oilseeds Federation)

12.2 Pre harvest check lists

12.2.1 Row spacing - narrow or wide?

This is primarily an agronomic decision but the decision has an effect on harvest performance. Plants grown in narrow rows (e.g. 178 mm (7 inch drilled beans)) tend to grow taller on a single stem. This means that the lowest pods will be higher and if you own an older fixed-platform head that will mean much lower gathering losses. If you have the area, it pays handsomely to use a gathering head with a floating cutterbar. Using a pickup reel rather than a bat reel will give superior results. The floater and pickup reel can outperform a fixed platform and bat reel by as much as 5% of your crop. Modern draper-type heads have better capacity and have been offered with floating cutterbars over the past few years.²

12.2.2 Pre-harvest header/combine check

First check the cutterbar: worn and broken knife sections lead to significant losses and problems with weeds.

Check reel and auger settings as recommended in the operator's manual.

During normal pre-harvest servicing, be alert to sharp edges that can cause soybean damage and excessive splits.

Make sure that sharp edges are worn off or smoothed on augers, bubble-up, front elevator flights, and watch out for wear under chromed thresher elements.

Replace perforated screens under augers. Uneven concave and thresher elements result in uneven separator performance and damage.

While the feeder house is detached on walker machines, check for worn and bent rasp bars on the drum and set for uniform clearance between drum and concave. Check the operators' manual regarding concave wire recommendations and all settings for soybeans.

Be sure the stone trap is emptied of rocks.

Excessively worn clean grain and return elevator slats and loose chains cause grain to flow back and accelerate seed damage.³

12.3 Harvest timing

² Australian Oilseeds Federation (2013), Better Soybeans manual http://www.australianoilseeds.com/soy_australia/Soybean_Production

³ Australian Oilseeds Federation (2013), Better Soybeans manual http://www.australianoilseeds.com/soy_australia/Soybean_Production

Moisture measurement is critical. Harvest could start at 17% moisture content when there are still a few leaves on the plants, but may lead to a need for drying. Ideal harvest moisture is 12-14%. Lower moisture content will result in more losses due to shatter and to threshing damage. Check your moisture meter (whether hand-held or on-board) against a reliable standard.⁴

12.4 Desiccants

Crop desiccants/harvest aids like Reglone® or Roundup PowerMax® are commonly needed in coastal areas and other seasonally humid areas to manage weeds, hasten leaf drop and facilitate uniform harvest conditions. Weigh up the costs of a desiccating operation on crop damage and losses due to running down some of the crop. Speak to an agronomist experienced in desiccation of soybeans when deciding when and how to desiccate.⁵

12.5 Harvest losses

Losses in a soybean crop cost the grower significantly; irrespective of whether food grade or stock feed varieties. Every kilogram of seed lost at harvest eats into profits. Smart harvest operators and managers find out where harvesting losses occur, know how to measure them and decide what reasonable losses are. Machines and operating practices are then set to minimise losses.⁶

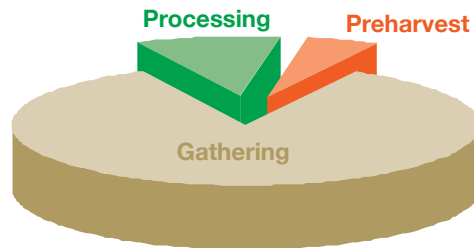

Figure 3: Representation of soybean losses at harvest. Gathering losses can be as high as 85% of all losses in this crop. (Photo: Australian Oilseeds Federation)

12.5.1 How to measure harvest performance

Harvester capacity must be specified at a pre-determined loss level. International standards specify that combine harvester capacity be rated at the 1% processor loss level in both wheat and in soybeans. That does not include gathering losses. Periodically checking for lost soybeans on the ground behind the header is essential to assess the gathering head performance and is essential to calibrate the loss monitors. Monitoring grain loss on the ground does not however tell the whole story. For example, grain that is damaged in the thresher is likely to be blown out the back and unrecoverable. Powdered soybeans don't end up in the grain bin.

The two areas needing closest attention are the gathering area and the processor. It's the gathering area where the most losses occur at harvest in soybeans.

The difference between the 'pristine crop' growing in the paddock and what is in the header bin are the sum of all losses, that is: ⁷

Pre harvest + gathering + processor losses

⁴ Australian Oilseeds Federation (2013), Better Soybeans manual http://www.australianoilseeds.com/soy_australia/Soybean_Production

⁵ Australian Oilseeds Federation (2013), Better Soybeans manual http://www.australianoilseeds.com/soy_australia/Soybean_Production

⁶ Australian Oilseeds Federation (2013), Better Soybeans manual http://www.australianoilseeds.com/soy_australia/Soybean_Production

⁷ Australian Oilseeds Federation (2013), Better Soybeans manual http://www.australianoilseeds.com/soy_australia/Soybean_Production

Table 1: Targeted loss levels: ideals to maximise soybean harvest performance

Loss	As percent of total yield	As kg/ha in average crop of 2.7 t/ha	As dollars lost per ha for soybeans worth \$500/t
Pre Harvest	0.25%	6.75	\$3.40
Gathering			
- Shatter loss	2%	54	\$27
- Stalk/ cutterbar	0.5%	13.5	\$6.80
- Lodged loss	0.5%	13.5	\$6.80
- Stubble loss	0.75%	20.25	\$11.25
Processing:			
- Cylinder	0.25%	6.8	\$3.40
- Separator	0.5%	13.5	\$6.80
Notional totals	4.75%	128.25	\$64.13

12.5.2 Pre-harvest losses

It is impossible to step into a mature soybean crop without dislodging a bean or two, so losses from a large harvesting machine are inevitable. Pre-harvest losses under most conditions should be less than 0.25% of bin yield. The situation changes when soybeans dry to a very low moisture content. Weeds proliferate or vermin inhabit the crop due to delayed harvest.

Pre-harvest losses are not attributable to the harvester; that is, soybean seeds and pods on the ground plus soybeans that decline in quality (mould, etc) due to any harvest delays. Pre-harvest losses are aggravated when harvest is delayed. Soybeans shatter out of pods when they dry out. This is accelerated when wetting and drying cycles occur in the maturing crop. The ideal time to harvest is when the beans reach physiological maturity and reach a safe storable moisture content of 13% (wet basis). However in some situations, there is a case for harvesting early at higher than normal storage moisture and physically drying and aerating the beans in order to minimise pre-harvest losses.

Losses in the gathering zone (commonly referred to as the 'front'): A number of studies have established that around 85% of soybean losses at harvest are due to the gathering head—mostly caused by the cutterbar, but also from the reel and the platform auger. The key point affecting these front-end losses is podding height of the soybean crop.

Agronomic practices affect gathering losses: Podding height is greatly affected by several agronomic factors, such as row spacing and plant population density. Soybeans on very narrow rows (~175 mm) tend to be spindly and pod higher. Whilst superior for harvesting there is also a higher risk of plants lodging in heavy weather. With wide row spacings, soybean plants branch and will grow pods to ground level, which makes it very difficult to get them all into the gathering head. As a general rule, flat ground is better than beds as far gathering losses as are concerned.

Gathering losses chargeable to the machine can be defined as follows:

- Shatter loss: free beans and beans in pods that are detached from the plant.
- Stalk loss: beans in pods still attached to the plant on the stem or on branches but that were not collected by the gathering head (sometimes called cutterbar loss).
- Lodged loss: Beans in pods attached to stalks and branches abnormally longer than the stubble, these are beans, which slipped under the cutterbar.
- Stubble loss: Beans in pods attached to the freestanding stubble left behind the machine.

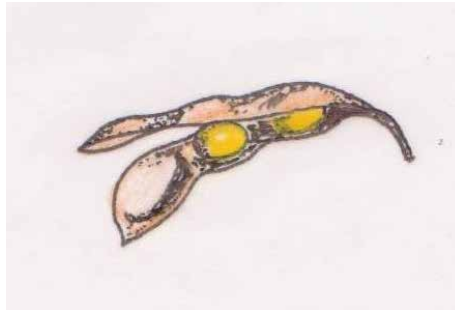

Figure 4: Soybean pods dehisce after maturity - the more so as the crop dries out or if the pods are subject to rewetting and drying. (Photo: Australian Oilseeds Federation)

Paying attention to each of these can be instructive in machine operation to rectify and minimise losses.

Plant varieties that are less shatter-prone and pod higher: There are varietal differences that impact harvest losses. Narrow rows (e.g. ~175 mm rows) promote higher pods and less branching, but are more at risk of lodging.

Weather Influences at Harvest Time: Front loss increases exponentially as field moisture drops below 13%, which is considered safe storage moisture for up to six months. For safe storage over 12 months, soybeans need to be dried to 11% moisture content or lower.⁸

12.5.3 Gathering losses

Gathering losses take place at the front. After the machine has passed through the crop, closely examine the ground behind the wings of the header and look for:

Shatter Loss: Free soybeans and beans in detached pods.

Stalk or Cutterbar Loss: Soybeans in pods still attached to plant stems or branches that are cut but not collected.

Lodged Loss: Soybeans in pods attached to stalks and branches abnormally longer than the stubble. These have slipped under the cutterbar.

Stubble Loss: Soybeans in pods attached to the free-standing stubble left behind the machine.

Stripping Loss: This is standing stalks and branches that have pods attached or popped open that are leaning in the direction of travel—due to travelling too fast, defective knife sections, and/or incorrect reel positioning.⁹

⁸ Australian Oilseeds Federation (2013), Better Soybeans manual http://www.australianoilseeds.com/soy_australia/Soybean_Production

⁹ Australian Oilseeds Federation (2013), Better Soybeans manual http://www.australianoilseeds.com/soy_australia/Soybean_Production

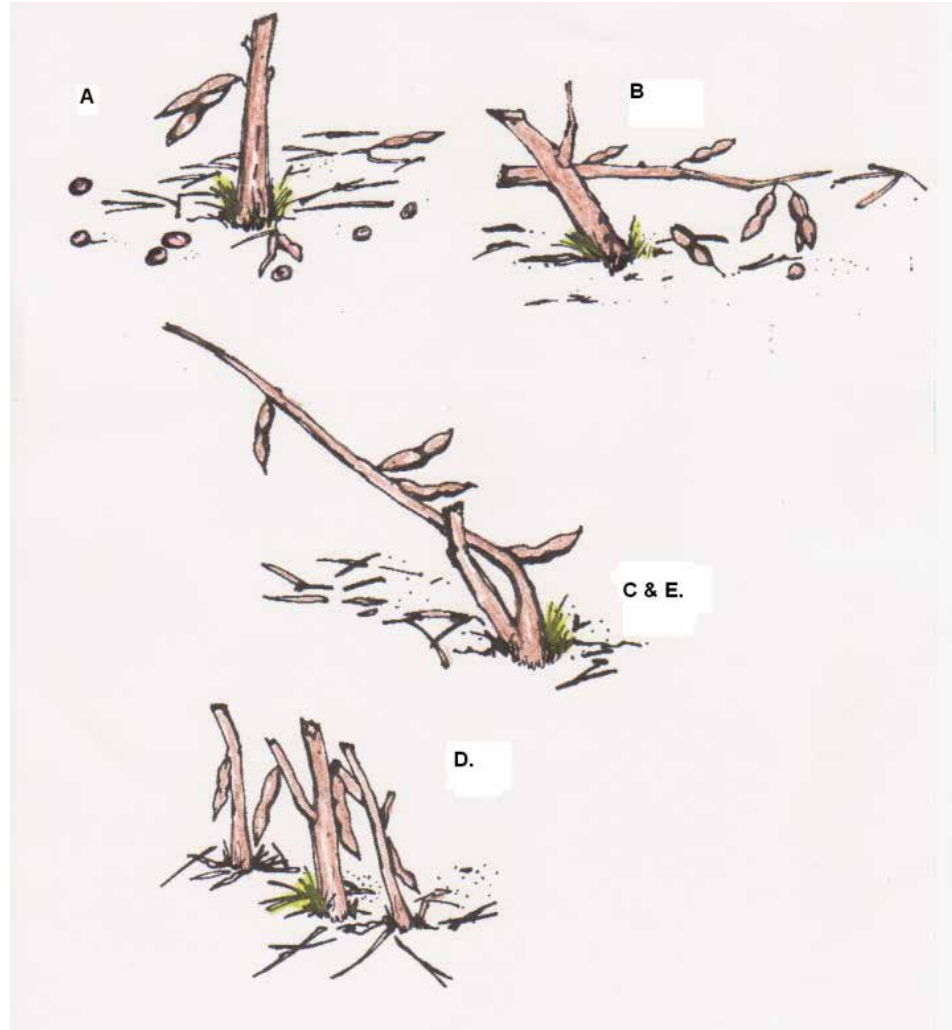

Figure 5: Where to measure losses. After cutting in a uniform area in the crop, the harvester should be backed off a few metres to assess the losses. (Photo: Australian Oilseeds Federation)

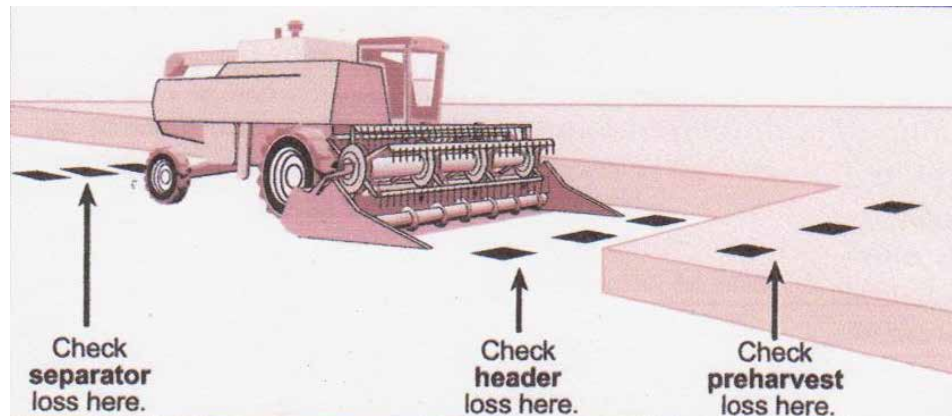

Figure 6: Gathering losses at the front of the machine. (Photo: Australian Oilseeds Federation)

Machine factors: For the best possible harvest job in soybeans, it is essential to harvest with a floating cutterbar for soybeans (known as ‘Flex fronts’ in John Deere machines). Gathering losses with a floating cutterbar are half that of a rigid platform. Floating the cutterbar on skids close to ground level and independent of the platform enables the sickle to get under as many pods and branches as possible. By contrast, a fixed gathering platform will of necessity pitch and roll with the harvester as it traverses

ground irregularities. Maintaining a consistent low cutting height across the width of the front is impossible with a rigid platform. Admittedly, an auto height controller will reduce fixed platform gathering losses however cutting height control is also highly desirable with a floating cutterbar.

Floating the cutterbar not only permits faster forward speed for the same loss level but also minimises stones entering the platform, as do rock interrupting attachments. Rock barriers that mount behind the cutterbar are an optional attachment.

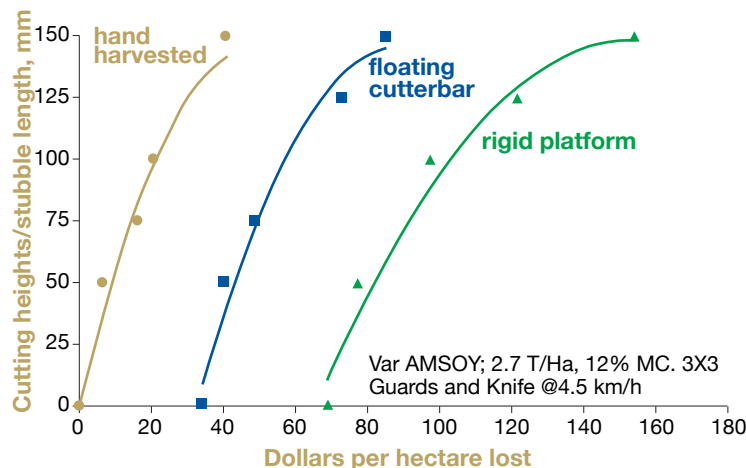

Figure 7: The influence of stubble length/cutting height on soybean gathering losses for a rigid front versus a floating cutterbar, compared with manually harvested quadrats. This data shows that a rigid platform has double the losses of a floating cutterbar, but it is obviously location- and variety-specific, so the actual numbers would not apply elsewhere. The two fronts were operated in a paired comparison on combines travelling at 4.5 km/hr in variety Amsoy. (Photo: Australian Oilseeds Federation)

Alternative cutterbar configurations. A narrow-pitched knife (e.g. Kwik-Cut or Tiger Jaws models) significantly reduces front loss in soybeans compared with the standard 3-inch sickle sections X 3-inch guards. This is mainly due to less stem movement during cutting.

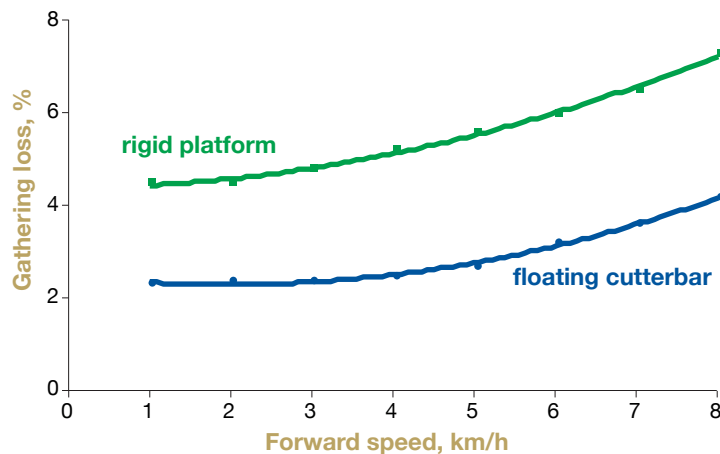

Figure 8: Influence of forward speed on gathering loss in 2.4 t/ha variety Hardome at 12.5% moisture content. Both platforms equipped with 3 X 3 cutterbars. (Photo: Australian Oilseeds Federation)

A pickup reel is a must. The 'feathering' pickup reel is best for soybeans—the reel tines enter the crop vertically for least disturbance and gently sweep the crop over the cutterbar and into the auger. A bat reel is cheaper but will shatter too many beans. Reel index (ratio of reel tip speed to forward speed) should be maintained around 1.25, which means that reel speed needs to be changed any time combine speed changes. That is

readily accomplished with auto reel speed control on the combine. Reel position and tine pitch need to match to crop conditions.

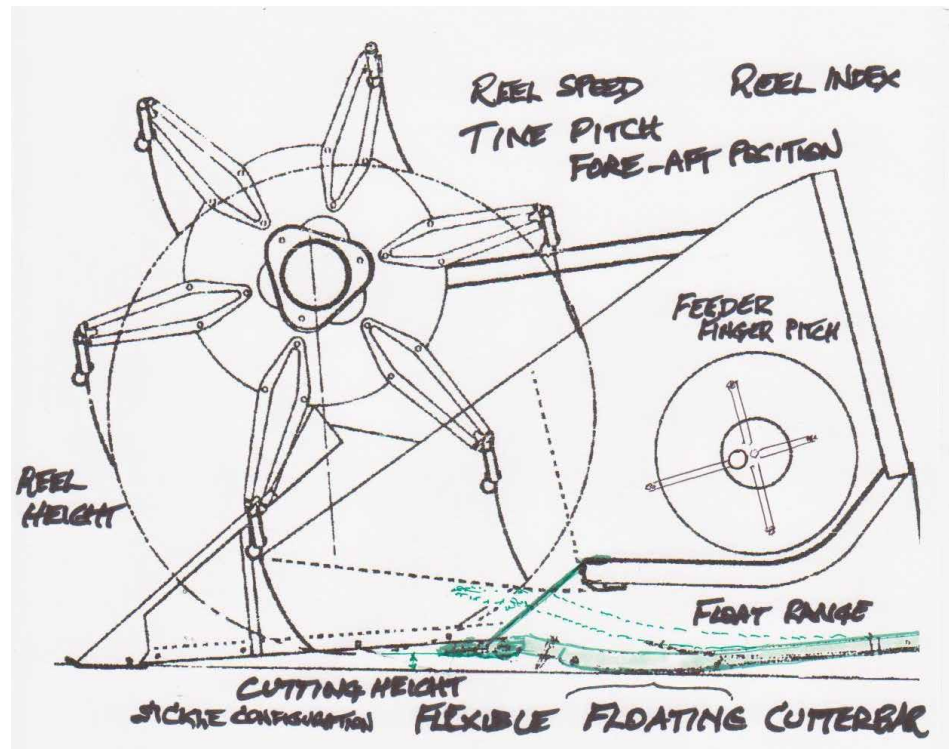

Figure 9: Critical platform adjustments. This shows an after-market floating cutterbar. (Photo: Australian Oilseeds Federation)

Some makers (Deere and Claas) offer a variable-width platform, which is desirable in short crops to minimise the “Dead Zone” where the reel tines sweep over the platform and lift just ahead of the auger.¹⁰

12.5.4 Processor losses

The throughput of a combine harvester can be no greater than what the gathering head can digest. That fact reinforces the importance of optimising gathering front settings for high capacity at minimal loss.

Soybeans are comparatively easy to thresh and separate. Green stems result in heavy slugging and ‘roping’ in the processor. Processor performance is best with smooth/even crop feeding. However, in paddock conditions with a high yield crop that has green stringy stems and green weeds present, “lumpy”/uneven feeding and less-efficient threshing occurs. A draper type head provides smoother flow and more crop feeding into the processor heads-first.

The processor shells the pods and should do that without causing excessive damage and splits. The cleaning system should remove weed seeds and foreign matter in the bin sample. The art is to balance a complete thresh against gentle threshing using the appropriate processor (rotor or cylinder) speed. Monitoring the tailings return to check whether it is grain-rich or chaff-rich is one gauge of thresher performance. Obviously the operator’s manual is the appropriate place to start for any given machine’s settings.

For soybeans the rotor or cylinder needs to be running at a peripheral speed of around 18 m/sec (3,500 ft/min). For a 760 mm (30 inch) rotor diameter, as on a Deere STS or Case-IH 9020 for example, that means a rotational speed of around 450 rpm. Round

¹⁰ Australian Oilseeds Federation (2013), Better Soybeans manual http://www.australianoilseeds.com/soy_australia/Soybean_Production

concave bars are gentler than rectangular bars. Removal of concave wires may be desirable to allow seeds to escape early through the concave in soy.

Grain damage increases with rotor or cylinder speed squared. Seed damage also increases with moistures over 14%.



Figure 10: Threshing rotor 'out to get' a soybean pod! Threshing is a combination of impact, pinching and shearing. There is least seed damage when there is a cushion of crop in the processor. Thresher speed needs to be kept as low as possible consistent with thorough pod shelling. (Photo: Australian Oilseeds Federation)

Minimising losses from the cleaning shoe: Remove any perforated screens under elevator doors, cross augers or under the unloading auger tube in soybeans. Open the chaffer (upper sieve) wide enough (e.g. 5/8 inch or 16 mm) to prevent clean soybeans being carried on to the returns system, likewise, the lower sieve should be set initially at say 3/8 inch or 10 mm.

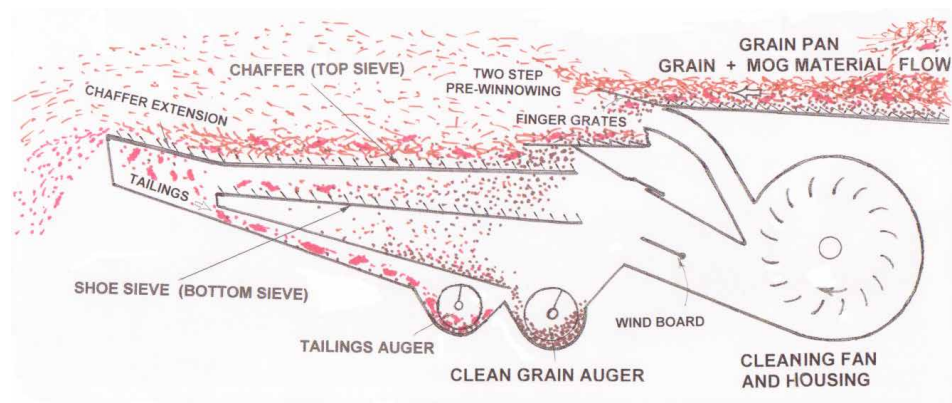

Figure 11: Cross-section of a representative combine cleaning shoe. Comprehending crop flow here helps with settings for best performance. Engine speed needs to be maintained for consistent shoe performance. If the cleaning system speed (including the fan) slows, shoe losses escalate. Examination of the tailings return flow tells much about shoe performance. (Photo: Australian Oilseeds Federation)

Adjust only one setting at a time: An under-loaded machine will cause more seed damage, so too will worn components that have been chrome plated to expose sharp edges. Harvesting machines are designed to operate best when engine speed is maintained—the cleaning shoe in particular is quickly affected if the engine slows.

Making only one adjustment at a time gives the operator a better idea of where performance can be improved.¹¹

Table 2: The importance of operator skill level—eg. For three operator skill levels in an average soybean rield of 2.7 t/ha with soybeans at \$500/t

	Total losses, %	Harvest rate, ha/h	Cost of those losses \$/ha	Gain over mug operator, \$/hour	Loss over a top gun \$/hour
'Inexperienced'	10%	5	135	-	523.2
'Average'	5%	5	67.50	185.7	185.7
'Top operator'	2.25%	5	30.4	523.2	-

12.6 Bin sample quality

What's up in the bin - measuring sample quality: The receival centre test for sample quality usually involves passing a sub-sample through a 10/64 X 3/4 inch screen. The sample is visually tested for discernible damage, brokens and splits, foreign material, and weed seeds. Test weight diminishes when seed damage is excessive.

Grower payment is conditional on total delivered, on moisture content, on test weight and on seed sample quality and purity.

How much do losses cost? Crop return, and the value of the harvest or cost of losses is calculated simply as:

Dollars per hectare = Dollars per tonne X Tonnes per hectare.

12.7 Handy hints

Most losses occur at the front in soybeans: Focus on the front. About 85% of soybean losses take place at the front. And they start at the cutterbar. The cutterbar must get under the lowest pods and branches.

Floating cutterbars: For best results harvesting soybeans, a floating cutterbar/flex front is essential. If not already installed, these may be bought as an aftermarket attachment. For small grain harvest the flexible floating cutterbar can be locked up like a rigid front. Narrow sickle sections are better than the standard 3 X 3 guards and sections in soybeans. An air reel and a Vibramat are worth the extra in short and light crops. The key to reduced losses is to minimise stem movement at the sickle.

Auto Height Controller: Height controllers and height indicators are invaluable if fitted, not only to maintain low cutting but also to minimise the risk of gouging and picking up dirt.

Pickup Reels: Do not harvest soybeans with a bat reel as they result in significantly higher losses than feathering pickup reels. There are reel options available for soybeans too, such as the Orbit reel, paddle fingers and extra-large diameter model reels.

A rigid cutterbar: If using a rigid platform it needs to be operated dead level with (and low to) the ground. Significant crop losses will occur if one end is in the air and the other is in gouging the dirt. Lateral height controllers on the platform are particularly useful with wide fronts if you have to use a rigid platform.

Platform auger: Set the platform auger so there is about 18 mm clearance between the flighting and the bottom sheet of the platform. Also check that the retractable fingers

¹¹ Australian Oilseeds Federation (2013), Better Soybeans manual http://www.australianoilseeds.com/soy_australia/Soybean_Production

are timed according to the manual. That will facilitate more uniform feeding into the front elevator.

Flat ground: Flat ground is better than ridged-up beans. Narrow rows also facilitate the harvest as plants tend to pod higher and branch out less. At all times the aim is to get below the low pods.

Draper fronts feed better than an auger front: This improves processor performance, however draper heads do not normally come with a floating cutterbar. Some manufacturers now offer this as a combination. Ideally, this is the best harvesting setup. Uniform crop feeding of crop (minimum bunching) is important for best thresher/separators performance. There is a tendency for auger ("tin") fronts to feed in bunches in lighter crops and in weedy conditions. Draper fronts feed better and can increase combine capacity.

Many of these sources of loss can be reduced by due care with the cutterbar and reel. Combine forward speed should not be excessive. Travelling too fast results in higher or ragged stubble.

Check condition of cutterbar: Knife sections need to be intact and sharp, the knife needs to be in register, with hold-down clips correctly set. Knife condition is crucial in soybeans.

Alternative cutterbar configurations: A narrow-pitched knife (example Kwik-Cut or Tiger Jaws models) significantly reduces front loss in soybeans compared with the standard 3-inch sickle sections X 3-inch guards. This is mainly due to less stem movement during cutting.

Reel speed and position critical. The reel needs to be run around 25% faster than the forward speed and be adjusted for height and forward position to match the crop. In addition, reel tine pitch needs to be near vertical or else teeth tilted back towards the cutterbar if the crop is lodged.

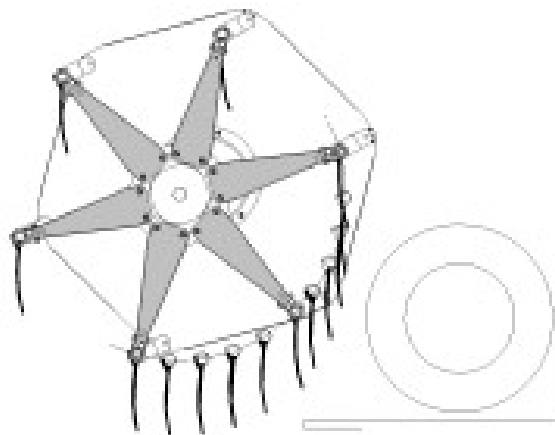

Figure 12: Note that a pickup reel enters and leaves the crop vertically for least stem disturbance. The reel should be positioned to sweep the crop over the platform into the auger or onto the draper. (Photo: Australian Oilseeds Federation)

Minimising processor losses: Start with the operator's handbook settings for drum speed, concave openings, vane angles, fan speed and sieve settings. If crop conditions demand a change—change only one setting at a time and note the difference. Thresher speed, for example, should be slowed to the point where damage and splits are acceptable but at the same time maintaining acceptable threshing losses (very few intact pods in the sample). Operate to maintain a cushion of crop in the processor for least damage to soybeans. When unloading, slow the engine to reduce seed damage by the unloading auger. Where possible, use belt conveyors and avoid augers when moving soybeans around the farm.

Calibrate the loss monitors: Loss monitors only measure relative loss and need periodic calibration. They do a good job of indicating relative performance. This means an operator must periodically assess losses on the ground.

Monitor tailings returns: Check tailings returns regularly to see whether that flow is grain-rich or chaff-rich. Alter sieve settings to match the indication from the tailings flow.

Assess grain sample for foreign matter. Foreign matter is affected by crop and harvester settings.

Engine speed: The engine needs to be operated at rated speed at all times during harvest for consistent performance. A slowing engine will quickly affect the cleaning system first. If cleaning system speed slows (especially fan and shoe shake), shoe losses escalate. In the worst case a slowing engine can lead to plugging. Watch the power monitor if fitted.

Kill-stop: Performing a kill-stop or plug-stop is for trained operators only but is valuable to indicate performance of various processor components of the machine. See manual for procedure and follow those steps exactly, otherwise engine damage or operator accidents can occur.¹²

12.7.1 How to measure losses

Total Loss = Pre-Harvest Loss + Gathering Losses + Processor losses

(Usually expressed as a percent of total yield, which in turn is bin yield plus losses—it can also be expressed and more conveniently as percent of bin yield, if field losses aren't exorbitant). Table 1 gives some notional numbers for acceptable losses, and what the losses will cost.

The trick is to use several sampling frames randomly placed in a uniform part of the crop and behind the machine. Get down on the ground and count beans inside the frame(s). In simplest terms, four beans in a frame on the ground in 1/10th m² (say 32 cm X 32 cm) frame area represents 76 kg/ha loss.

In reality, isolating processor losses from gathering losses measured behind the harvester is a lot more complicated and requires that the chaff spreader(s) and straw chopper be disconnected, as well as accounting for pre-harvest loss. On the latest combines those are difficult or impossible to disconnect and keep running without plugging the machine!¹³



Figure 13: The effluent chaff and the straw need to be spread as wide as the gathering front to facilitate subsequent field operations and eliminate header trails. Bunched material post harvest may interfere with the seeding operation of the following crop. (Photo: AustralianOilseeds Federation)

12.7.2 Buying a Harvester

There are two categories of harvesters in Australia: rotary versus hybrid and walker type, in a range of sizes. All models are imported. They come in six primary colours: (in order

¹² Australian Oilseeds Federation (2013), Better Soybeans manual http://www.australianoilseeds.com/soy_australia/Soybean_Production

¹³ Australian Oilseeds Federation (2013), Better Soybeans manual http://www.australianoilseeds.com/soy_australia/Soybean_Production

of sales numbers) Case IH, Deere, New Holland, Claas - and AGCO with two brands (MF and Gleaner). Rotary harvesters dominate the market but there are still many walker types in use for soybeans - older machines that tie up far less capital. Rotaries generally do less damage and are more forgiving for processor settings, but a skilled operator can still achieve a high quality job with a walker-type machine, as long as it has a floating cutterbar front.

Alternatives to owning: What are the options? If a grower has a small area of soybeans or otherwise can't afford to tie up capital in a combine the options are: to bring in a contractor (is a contractor available on time?), share ownership, or lease a machine.¹⁴

12.8 Wet harvest issues and management

The only limitation to growing soybeans in a double cropping system is the risk of a wet harvest for both the winter and summer crops. This can delay harvest and the planting of the next crop. But that's not just a problem for soybeans, it's for all summer crops. (Southern NSW)

Agronomist's view

More information

[Grain Trade Australia Trading Standards](#)

More information

[North Coast NSW Planting Guide](#)

12.9 Receival standards

Soybean quality standards: Soybean delivery standards are different according to end-use; processing, culinary, seed beans and forage soybeans. Receival standards are readily available.

12.10 Harvest weed seed management

The use of perennial pasture leys can reduce weed seed levels in the soil and restore soil structure. high density, warm-season forage crops can be used to smother weeds. slashing after grazing can prevent weeds from producing seed.¹⁵

¹⁴ Australian Oilseeds Federation (2013), Better Soybeans manual http://www.australianoilseeds.com/soy_australia/Soybean_Production

¹⁵ Australian Oilseed Federation, Soybean North Coast NSW Planting guide http://www.australianoilseeds.com/_data/assets/pdf_file/0020/7670/Soybean_North_Coast_NSW_Planting_Guide.pdf

SECTION 13

Storage

13.1 How to store product on-farm

Choosing to store oilseeds on-farm requires attention to detail as there are limited tools available when compared to storing cereal grains.

To retain soybean market value care must be directed at maintaining seed quality, visual appearance and freedom from contaminants such as mould, insects and unregistered chemicals.

The handling of whole soybeans involves conveying and transporting from the farm to end-user. It is possible for soybeans to be handled as many as 5 times from the time they leave the farm until processing.

The structure of a soybean seed makes it susceptible to splitting and breakage during mechanical handling. The percentage of broken soybeans can be as high as 4.5% with a free fall drop of 30 metres. Bucket elevators and belt conveyors result in less damage when compared to the standard auger. When augers are used, run them to capacity to reduce seed damage.

Over-dry soybeans or soybeans that have been subjected to a number of rain events just prior to harvest are also more likely to split. The storability of soybeans is affected by the degree of damage to the seed coat. Damaged seed favours storage insect pest and moulds. Inspect soybeans for mechanical and other forms of damage prior to storage. If the amount of broken or split soybeans is high, it may be prudent to separate the broken or split grains by grading. Gradings can then be sold or used first rather than stored with the original better quality seed.¹

13.1.1 Types of storage

Ideal storage for soybeans is a well designed cone based “sealable” silo with “aeration”.

The aim is to minimise damage to seed when moved, ease of cleaning/hygiene for empty storages and suitability of effective use of aeration cooling.

If seed requires insect control, the silo is then sealed (gas tight) for the required period as stated on the pesticide label (usually 7-10 days) to enable effective phosphine fumigation to take place.

For all storages types, extra caution should be taken to prevent storm/rain water ingress into storages.²

¹ Australian Oilseeds Federation (2013), Better Soybeans manual http://www.australianoilseeds.com/soy_australia/Soybean_Production

² Australian Oilseeds Federation (2013), Better Soybeans manual http://www.australianoilseeds.com/soy_australia/Soybean_Production



Figure 1: Standard aeration cooling fan. (Photo: Australian Oilseeds Federation)

13.1.2 Deterioration indicators

Heating

Heating is a common indicator of a problem in stored grains and oilseeds. High grain temperatures normally indicate high grain moisture, microbial or insect activity. If left unchecked, this may lead to heat-damaged or charred grains.

Heating in cereal grains peaks at about 58°C then declines to ambient temperature. At the peak temperature, insects and moulds are killed, thus making the process self-limiting. In soybeans, however, as heating progresses above 50°C, the oxidation of oil in soybeans becomes a self-sustaining process. Temperatures above 150°C may occur. At this extreme temperature, charring occurs and spontaneous combustion is possible, if sufficient oxygen is present at the hot spot. Hot spots must be cooled or dissipated promptly. Moving the seed is one strategy. Do not aerate soybeans if a fire has already started, this makes the situation worse. A temperature monitoring system in bulk soybean storage is valuable.³

Change in colour and general appearance

In general, sound soybeans are plump with bright, uniform colour and free from unusual spots and shrivelled appearance. Discoloured soybeans are usually associated with inferior quality and lower market value. The change in colour is usually associated with higher moistures, temperatures and presence of moulds. This deterioration process can be detected by periodic drawing of samples from the stored soybeans. If detected, undertake aeration cooling or transfer the grain to another silo which cools the soybeans and break up hot spots during the conveying process. This may, however, be a less desirable choice due to the likelihood of increasing broken or split soybeans.⁴

Mustiness and off-odour condition

Musty odour usually indicates an advanced stage of insect or mould infestation and should be dealt with immediately. The soybeans should be aerated to remove the bad odour and to cool the seed. Beans should then be used at the earliest opportunity. Grain should be fumigated if insects are present. A sharp odour may indicate rancidity due to chemical changes in the oil component.⁵

³ Australian Oilseeds Federation (2013), Better Soybeans manual http://www.australianoilseeds.com/soy_australia/Soybean_Production

⁴ Australian Oilseeds Federation (2013), Better Soybeans manual http://www.australianoilseeds.com/soy_australia/Soybean_Production

⁵ Australian Oilseeds Federation (2013), Better Soybeans manual http://www.australianoilseeds.com/soy_australia/Soybean_Production

Presence of storage insects

Regular monthly inspections and sampling of all storages is essential to check both grain quality and for the presence of storage pests. Sieve grain samples from the top and bottom of storages and use reference material to correctly identify any pests detected. The use of probe or pitfall insect traps located in the grain surface is also a helpful additional tool for early detections of storage pests.⁶



Figure 2: Grain spear and insect sieve. (Photo: Australian Oilseeds Federation)



Figure 3: Grain insect sieve. (Photo: Australian Oilseeds Federation)

⁶ Australian Oilseeds Federation (2013), Better Soybeans manual http://www.australianoilseeds.com/soy_australia/Soybean_Production

Lumping and caking

Lumping and caking indicates an advanced stage of fungi invasion in soybeans. In metal silos, caking usually occurs on the walls or grain surface as a result of “sweating” or moisture condensing on inner surfaces of cold silo walls/roof. The condensing moisture is absorbed by the adjacent grains resulting in either sprouting or mould growth. A leaky silo roof/hatch may also be the cause of lumping and mould.⁷

Chemical changes in storage

Stored soybeans may undergo chemical changes even under ideal storage conditions. One common indicator of chemical change is the level of free fatty acid (FFA) present. An increase of FFA above 1% may translate into lower quality of its oil content. Decline in soybean seed germination and vigour can be rapid. Careful attention to storage temperature and moisture conditions has the largest influence on minimising problems.⁸

13.2 Stored grain pests

There are a number of insect pests that will infest stored oilseeds, usually favouring the grain surface. These are bruchids (*Callosobruchus spp.*), rust-red flour beetle (*Tribolium castaneum*), Indian meal moth (*Plodia interpunctella*), warehouse moths (*Ephestia spp.*) and psocids (*Liposcelis spp.*).



Figure 4: *Bruchids (Callosobruchus spp.)*. (Photo: Australian Oilseeds Federation)

⁷ Australian Oilseeds Federation (2013), Better Soybeans manual http://www.australianoilseeds.com/soy_australia/Soybean_Production

⁸ Australian Oilseeds Federation (2013), Better Soybeans manual http://www.australianoilseeds.com/soy_australia/Soybean_Production



Figure 5: Rust-red flour beetle (*Tribolium castaneum*). (Photo: Australian Oilseeds Federation)



Figure 6: Indian meal moth (*Plodia interpunctella*). (Photo: Australian Oilseeds Federation)



Figure 7: Warehouse moths (*Ephestia* spp.). (Photo: Australian Oilseeds Federation)



Figure 8: Psocids (*Liposcelis* spp.). (Photo: Australian Oilseeds Federation)

These pests multiply rapidly given food, shelter and warm, moist conditions. They can complete their full life cycle in about 4 weeks under optimum breeding conditions.

Only a few treatments are registered for insect control in stored oilseeds. Phosphine, Pyrethrins, Diatomaceous Earth (DI) and Ethyl Formate as Vapormate[®]. Pyrethrins and DI use should be limited to storage area treatments and Vapormate is restricted for use by licenced fumigators only. This leaves phosphine as the key farm storage treatment for oilseeds storage pests.

Phosphine fumigation must take place in a gas tight, well sealed silo. If the silo passes a standard three minute pressure test, it shows there are no serious leakage points. Given this, phosphine gas can be held at high concentrations in the silo for sufficient time to kill all the life stages of the insect pest (eggs, larvae, pupae, adults).



Figure 9: Phosphine tablets are placed in trays. (Photo: Australian Oilseeds Federation)



Figure 10: Australian standards for sealed silos. (Photo: Australian Oilseeds Federation)

When purchasing a new silo that may be used for fumigation, ensure the silo manufacturer builds it to meet the Australian standard. A number of silo manufacturers now make an aeratable, sealable silo which passes the Australian Standard (AS 2628-2010) for sealed silos.

Like most oilseeds, soybeans have the ability to absorb phosphine gas and so it is important to use the full, correct label dose rate.

By using phosphine bag-chains, belts or blankets, placement and removal of the treatment is simplified. If using the standard phosphine tablets, ensure tablets are kept

separate from the seed by using trays so the spent tablet dust can be removed after fumigation.

If aeration cooling has been in use and the seed temperature is less than 25°C, ensure the exposure period is 10 days or more. Refer to phosphine label for further directions and information.

Once the fumigation exposure period is completed, release the top lid, vent the gas for the required period and return the stored soybeans to aeration cooling.⁹

13.3 Grain protectants for storage

Most chemical surface treatments cannot be used on storages to be used to hold soybeans. Soybeans are classified as an oilseed, with limited chemical treatment registrations. Due to the oil content within the seed they are prone to absorbing chemical treatments. Following soybean processing, chemicals can be detected in the final oil product.

Warning—if unregistered chemical residues are detected by seed buyers, this can have serious long term consequences for both the domestic and export market.

Inert dust or Diatomaceous Earth (amorphous silica) is a naturally occurring mined product with insecticidal properties. Products such as DryacideR can be applied as a dust or slurry spray onto internal surfaces of storage areas and equipment. Once grain residues and dust have been physically removed or washed out of silos and equipment, DryacideR can be applied as a 'non-chemical' treatment to reduce insect pest carry over.

Insects survive in sheltered places with grain residues, including grain hoppers, field bins and inside headers. All these attractive locations should be cleaned as soon as storages are empty or equipment (headers, field bins, etc) are no longer in use. A pre harvest storage and equipment inspection and final clean is time well spent.¹⁰



Figure 11: Poor grain hygiene. (Photo: Australian Oilseeds Federation)

⁹ Australian Oilseeds Federation (2013), Better Soybeans manual http://www.australianoilseeds.com/soy_australia/Soybean_Production

¹⁰ Australian Oilseeds Federation (2013), Better Soybeans manual http://www.australianoilseeds.com/soy_australia/Soybean_Production

Some Pyrethrin + piperonal butoxide based products (such as Rentokil's Pyrethrum spray-mill specialR or Webcot's S-Py natural pyrethrum insecticideR) are registered for moth control in oilseed storage areas and sheds. They can be applied as structural surface spray or fogging/misting treatment. These are not grain treatments and should only be used as the label directs. Prior to using these insecticides in storages for export soybeans, it is important to check the buyer and importing country accept their use and have appropriate MRLs in place.

As a guide, the following Australian government DAFF web site lists various countries' grain, pulse, oilseeds MRLs for a range of chemicals.¹¹

<http://www.daff.gov.au/agriculture-food/nrs/industry-info/mrl>

13.3.1 Fire Risk

The dust and admixture associated with soybeans presents a fire risk. Harvesting and drying operations are high risk operations where constant vigilance is required. Good housekeeping in and around equipment and keeping a close eye on problem sites reduces the threat.

In case of a fire, ensure appropriate equipment is at hand and a response plan is understood by all operators.

Without careful management, high moisture content soybeans and/or high admixture pose a risk of mould formation, heating and fire through spontaneous combustion.¹²

13.4 Aeration during storage

Aeration should be considered as an essential storage tool for soybeans.

Aeration benefits:

- maintains grain quality (e.g. colour, oil quality)
- reduces risks of hot spots, moisture migration and mould development
- slows or stops storage insect breeding cycles by maintaining cool grain temperatures
- maintains germination and seed vigour¹³

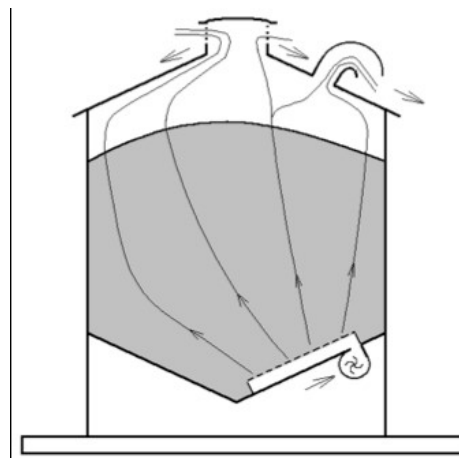

Figure 12: Air flow through grain bulk. (Photo: Australian Oilseeds Federation)

¹¹ Australian Oilseeds Federation (2013), Better Soybeans manual http://www.australianoilseeds.com/soy_australia/Soybean_Production

¹² Australian Oilseeds Federation (2013), Better Soybeans manual http://www.australianoilseeds.com/soy_australia/Soybean_Production

¹³ Australian Oilseeds Federation (2013), Better Soybeans manual http://www.australianoilseeds.com/soy_australia/Soybean_Production

13.4.1 Aeration cooling

Fans that provide low air flow rates of around 2-4 litres per second per tonne (L/s/t) can both cool seed and provide uniform moisture conditions in the storage. If managed correctly, aeration allows safe storage of grain at moisture levels a little above receival standards for several weeks.

Well managed cooling aeration typically sees seed temperatures fall safely to around 20°C and below within days.

Regular checking of soybeans in storage is essential. Make visual inspections, check grain moisture, sieve for insects, use a temperature probe or temperature cables inside silos to monitor seed temperatures.¹⁴

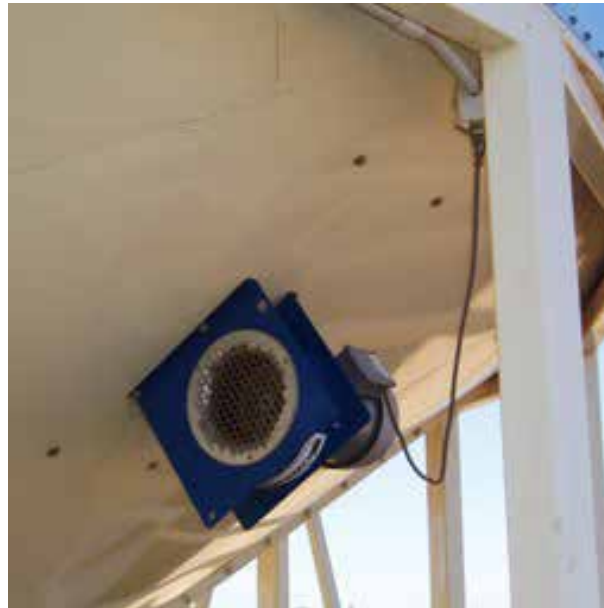

Figure 13: Standard aeration cooling fan. (Photo: Australian Oilseeds Federation)

13.4.2 Automatic controllers

Often aeration cooling fans are simply turned on and off manually or a timer clock is used. However, there is a lot to be gained by investing \$5000 to \$7000 in an automatic controller that selects the optimum run times and ambient air conditions to have fans operating. It has the ability to control fans on multiple silos. The controller continually monitors ambient air temperature and relative humidity and may select air from only 2 or 3 days in a week or fortnight. On average it runs cooling fans for approximately 100 hours per month.¹⁵

¹⁴ Australian Oilseeds Federation (2013), Better Soybeans manual http://www.australianoilseeds.com/soy_australia/Soybean_Production

¹⁵ Australian Oilseeds Federation (2013), Better Soybeans manual http://www.australianoilseeds.com/soy_australia/Soybean_Production

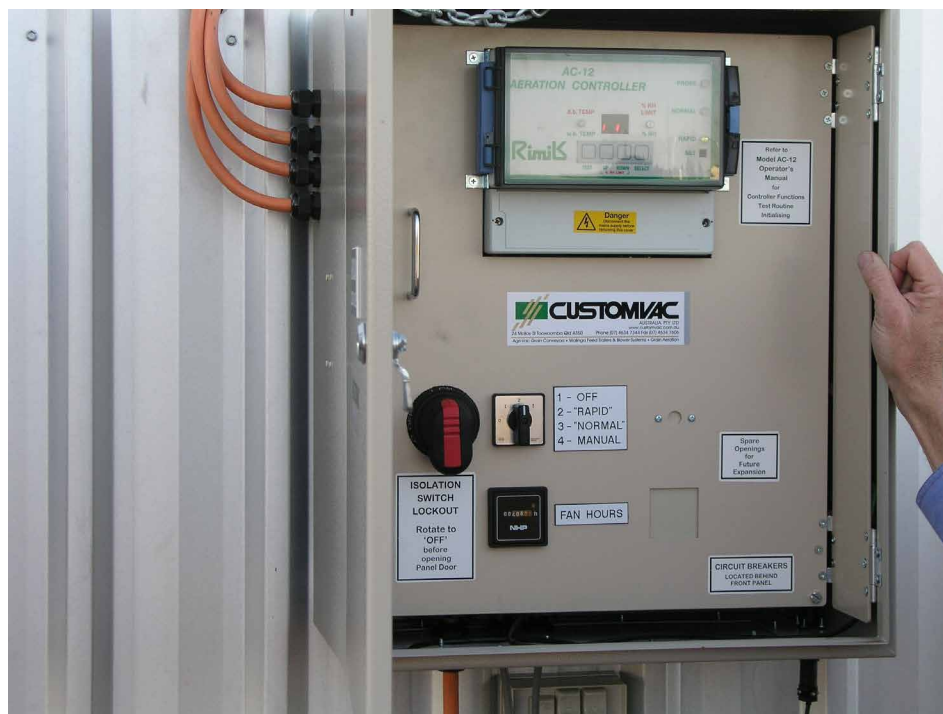

Figure 14: Automatic aeration controller. (Photo: Australian Oilseeds Federation)

13.4.3 Standard aeration fans operation

- Run fans 24 hours per day during the first 2-3 days when grain is first put in the silo. This removes the “harvest heat”. Smell the air coming from the silo top hatch. It should change from a warm humid smell to a fresh cool smell after 3 days. The first cooling front has moved through.
- For the next 3-5 days set the controller to the “Rapid or Purge” setting. This automatically turns the fans on for the coolest 9 to 12 hours of each day to further reduce the grain temperature.
- Finally set the controller to the “Normal or Continuous” mode. The fans are now automatically turned on for approximately 100 hours per month, selecting the coolest air temperatures and avoiding high humidity air.

13.4.4 Aeration drying

Well designed, purpose built high flow rate aeration drying systems with air flow rates of 15-25 L/s/tonne can dry soybeans reliably. During aeration drying, fans should force large volumes of air through the seed bulk for long periods of time. This ensures drying fronts are pushed quickly through so the grain at the top of the silo is not left sitting at very high moisture contents.

Soybeans are well suited to this form of drying as ambient air at 30-60% relative humidity will reduce moisture content without the excessive heat risks associated with hot air driers. Monitor regularly and take care that grain in the silo base is not over dried.

Do not rely on aeration cooling equipment with low airflow rates of only 2-3 L/s/t to dry high moisture soybeans.

Automatic aeration controller models are also available that will run fans at optimum ambient air conditions for either cooling or drying functions. Ensure the controller is fitted with a good quality humidity sensor.¹⁶

¹⁶ Australian Oilseeds Federation (2013), Better Soybeans manual http://www.australianoilseeds.com/soy-australia/Soybean_Production

13.4.5 Heated air drying

For hot air drying of soybeans, fixed batch, recirculating batch or continuous flow dryers are all suitable for reducing moisture content.

Always consider the blending option first if low moisture seed is available.

Close attention must be given to temperature control and duration to ensure grain is not over dried. A wise precaution is to use the minimum amount of additional heat.

The following points are useful for heated air drying:

- Use air temperatures in the 40°–50°C range.
- Stay close at hand and monitor moisture content every 15 minutes.
- For batch dryers when moisture content reading reaches 13.5% turn off heat source and move to the grain cooling phase with fan only. Retest once cooled.
- Over-dried soybeans will split easily when moved and this damage could cause soybeans to fall outside of edible grade receival standards.
- Run auger full when moving soybeans to reduce seed damage and splitting.
- Aim to make good use of aeration fans, both before and after the drying operations.¹⁷

13.4.6 Moisture content

Moisture is perhaps the most important single factor affecting storage of soybeans. Soybean moisture content at harvest time usually ranges between 12% to 15% (wet basis). Soybeans above 13% should be dried to reduce the risk of deterioration. At higher moisture contents, there is a rapid increased in seed respiration leading to spontaneous heating, mould development, germination damage and oil quality deterioration. For long term storage (> 6 mths) below 12% is recommended.

Like all grains, soybeans is hygroscopic and will either lose (desorb) or gain (adsorb) moisture from the surrounding air. With soybeans in storage, aeration system require careful management as fans left running for too long under certain temperature and relative humidity conditions can result in damage by adding significant moisture to stored seed.

Table 1: Soybean equilibrium moisture content (EMC) at various temperature and humidity conditions. Example: If soybeans were constantly aerated with ambient air at 20°C and 70% relative humidity the soybeans would gradually move toward a moisture content of 12.8%.

Temperature (°C)	Relative Humidity (%)						
	50	60	65	70	75	80	90
0	10.0	11.8	12.7	13.7	14.9	16.2	19.8
5	9.8	11.5	12.5	13.5	14.6	15.9	19.6
10	9.5	11.2	12.2	13.2	14.4	15.7	19.4
15	9.2	11.0	11.8	13.0	14.1	15.5	19.2
20	9.0	10.7	11.7	12.8	13.9	15.2	19.0
25	8.7	10.5	11.4	12.5	13.6	15.0	18.8

13.4.7 Temperature

Temperature is another important factor influencing soybean storage. Growth of fungi and undesirable oil quality changes can increase with higher temperatures in both meal and whole beans. Insect pests in storage also develop and reproduce best between 25 and 35°C. Below 15°C insects become inactive and breeding ceases. Exposure to temperatures greater than 60°C kills most storage pest species in a few minutes.

Soybeans with a higher moisture content (e.g. 14–14.3%) can be stored for over two years without mould damage if maintained at cold temperatures of 5–8°C. In contrast

¹⁷ Australian Oilseeds Federation (2013), Better Soybeans manual http://www.australianoilseeds.com/soy-australia/Soybean_Production

bulk soybeans stored at 30°C can lead to mould development in some areas of the storage in a few weeks and severely damaged the seed in a few months. Dry soybeans (e.g. 10.5%) are unlikely to have mould problems develop.

Aim to store soybeans at less than 20°C and if possible less than 15°C as this will limit insect breeding, mould development and oil quality deterioration.

Aeration cooling of soybeans in bulk storage helps maintain seed quality. Using automatic aeration controllers to select the optimum fan run times adds an improved level of safety and reliability to achieving desirable storage conditions.

13.4.8 Duration of storage

Deterioration of soybeans and soybean meal in storage is a combined function of its moisture content, temperature, and duration of storage. Therefore to reduce the risk of seed quality damage, a combination of low product moisture, low temperature, and a short storage period is desirable.

13.4.9 Foreign material present

Foreign material in soybeans is defined in the standards as all materials that pass through a 3.2 mm round-hole sieve and all materials other than soybeans remaining on the sieve. Fine foreign materials tend to segregate during bin loading and occupy void spaces in the central region of the grain mass. Meanwhile, the large and lighter materials will accumulate close to the walls of the silo (Figure 15).

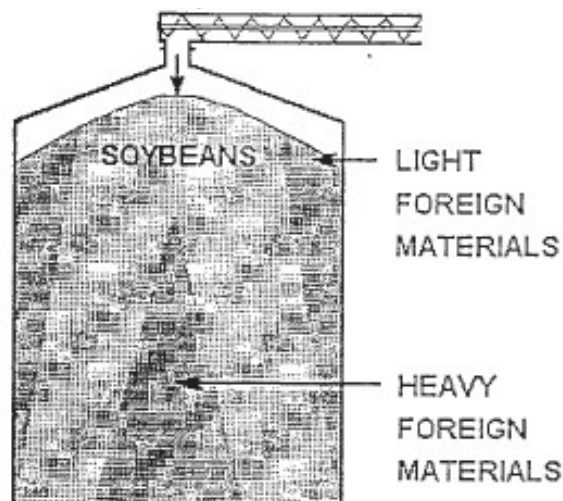

(Adapted from Barger, 1981)

Figure 15: Schematic diagram of how light and heavy foreign materials segregate when grain is loaded into a storage silo. (Photo: Australian Oilseeds Federation)

During aeration, the air will flow around spots with higher concentration of fine foreign materials and favour moving through pockets of high concentration of large foreign materials. Under these conditions there is a non-uniform flow of air during aeration.

Consequently, the areas of reduced air flow in the grain mass are potential sites for hot spots that provide an ideal environment for insects and moulds. Hence, cleaning soybeans prior to storage minimizes this risk. Pre-storage cleaning could be a valuable component of quality maintenance for processing companies.

13.4.10 Product condition and history

Sound whole soybean kernels will store better than kernels damaged by cracking, splitting, insects and fungi. While storage pest insects will attack whole soybeans and cause significant damage, it is the split kernels that provide a very attractive food source to a larger range of storage pests and fungi.

More information

[GRDC Factsheet Storing Oilseeds](#)

[GRDC Grain Storage Fact Sheet: Grain Storage Pest Control Guide Northern and Southern Regions](#)

[GRDC Grain Storage Facilities: Planning for efficiency and quality](#)

[Grain Storage: Grain Fumigation Guide](#)

A sound seed coat provides some degree of protection against attack. A grain handling system that minimizes cracking and splitting of soybeans is an advantage. Belt conveyors are recommended as they handle grain gently. They are also valuable for moving grains over greater distances without damage. The amount of broken and split kernels increases with every handling operation between harvest, processing and export.¹⁸

¹⁸ Better Soybeans, Australian Oilseeds Federation

SECTION 14

Environmental issues

14.1 Waterlogging/flooding issues for soybean

Plants in fields that are flooded for extended periods of time often die. Factors such as air and water temperature and whether the water is still or moving can influence the mortality rate. Poor drainage, low lying areas and compacted soil can all contribute to the period of inundation.

Waterlogging of soil during periods of heavy rain or flooding can leach vital nutrients from the soil and promote root diseases, as well as depleting oxygen supply to roots and nodules, which will reduce nitrogen fixation. These effects can cause stunting, yellowing and, in severe cases, plant death.

Waterlogging effects can be minimized by a combination of variety selection and improved land management. Sow varieties tolerant to phytophthora if waterlogging is expected, avoid planting in low lying areas, improve paddock drainage and avoid extended periods of water run during furrow irrigation.¹

14.2 Other environmental issues

14.2.1 Heat canker

In temperatures above 35°C, the seedling stems are girdled at or just above ground level by a red-brown ring. The affected seedlings usually die and re-planting may be required if a significant proportion of the stand is affected.

14.2.2 Salinity

Soil salinity tends to occur in patches across a paddock. Plants are stunted, wilted on hot days but recover at night, have small pale to grey leaves, and reduced flowering and seed production can occur. Older leaves tend to show symptoms first. In severe conditions younger leaves turn pale brown and the plant dies.

Salinity occurs in soils high in sodium and chloride ions in the soil solution and/or soils that were previously fertile but flooded or heavily irrigated with water high in salt. Irrigation water quality is important, as soybeans are more sensitive to saline conditions than other summer crops.

Salinity can be managed by testing soils to identify saline areas and by checking the quality of irrigation water. Apply gypsum and leach the soluble sodium and chloride beyond the rooting depth of plants. Rotate to deeper rooting plants such as perennials or more tolerant crops such as lucerne to help lower the water table.²

14.2.3 Soil acidity

Optimum soybean yields cannot be achieved in very acidic soil conditions. Soybeans are more sensitive to high levels of soil acidity than most other field crops. The optimum

¹ Australian Oilseeds Federation (2013), Better Soybeans manual http://www.australianoilseeds.com/soy-australia/Soybean_Production

² Australian Oilseeds Federation (2013), Better Soybeans manual http://www.australianoilseeds.com/soy-australia/Soybean_Production

pHw for soybeans on sandy and clay-textured soils ranges from 5.8 to 6.2, while yields often decrease as soil pH falls below pHw 5.5.

If soils are acidic, applications of lime or dolomite should be made well before planting. Remember that lime is slowly soluble in soil, and so time and soil moisture are necessary for the lime to be effective. It is preferable to develop a liming program to maintain soil pH in or near the optimal range, rather than trying to overcome extreme acidity in the months before planting. In other words, soil pH should be managed across the farming system, rather than as a specific input for a particular crop.

The effectiveness of lime or dolomite is generally controlled by purity and fineness. The finer the lime particles and the higher the purity (described as neutralizing value), the more rapidly and effectively soil acidity can be countered.³

14.2.4 Sooty mould

Sooty mould is a black powdery fungal growth that forms spots on the leaves, flowers and branches. It is not a disease of soybeans, but a secondary infection. Sap sucking insects, such as silverleaf whitefly and aphids, secreting honeydew cause conditions for the fungi to develop. The condition is more likely to occur in dry conditions as rain can wash the honeydew off the plant.

The mould hinders plant photosynthesis and may cause poor growth. High populations of sap sucking insects can cause the mould to expand to cover the entire plant. The mould is easily rubbed off the plant and may dry, flaking off if insect numbers are reduced. Irrigation can also be used to wash the mould from plants.⁴

14.2.5 Sunburn

This condition develops when leaves turn over and are exposed to intense sunlight. The lower leaf surfaces of the leaves develop a reddish colour. Generally only a small proportion of leaves are affected, so there is very little impact on yield.⁵

³ Australian Oilseeds Federation (2013), Better Soybeans manual http://www.australianoilseeds.com/soy_australia/Soybean_Production

⁴ Australian Oilseeds Federation (2013), Better Soybeans manual http://www.australianoilseeds.com/soy_australia/Soybean_Production

⁵ Australian Oilseeds Federation (2013), Better Soybeans manual http://www.australianoilseeds.com/soy_australia/Soybean_Production

SECTION 15

Marketing

The final step in generating farm income is converting the tonnes produced into dollars at the farm gate. This section provides best-in-class marketing guidelines for managing price variability to protect income and cash flow.

15.1 Selling principles

The aim of a selling program is to achieve a profitable average price (the target price) across the entire business. This requires managing several unknowns to establish the target price and then working towards achieving that target price.

Unknowns include the amount of grain available to sell (production variability), the final cost of that production and the future prices that may result. Australian farm gate prices are subject to volatility caused by a range of global factors that are beyond our control and difficult to predict.

The skills that growers have developed to manage production unknowns can be used to manage pricing unknowns. This guide will help growers manage and overcome price uncertainty.

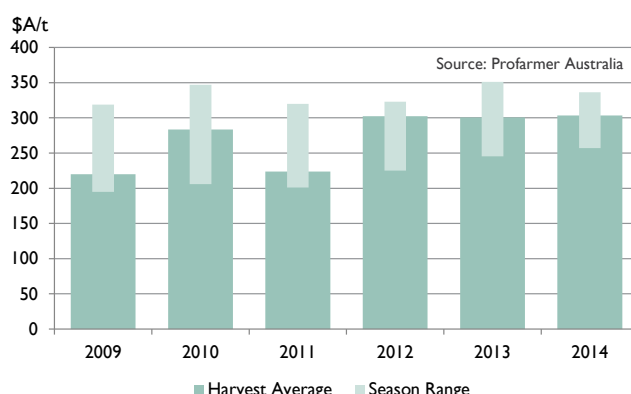
Note to figure:

Newcastle APW1 wheat prices have varied A\$70-\$150/t over the past 6 years (25-60% variability). For a property producing 1,000 tonne of wheat this means \$70,000-\$150,000 difference in income depending on price management skill.

Figure 1: Selling principles

15.1.1 Be prepared

Being prepared and having a selling plan is essential for managing uncertainty. The steps involved are to first form a selling strategy and then a plan for effective execution of sales.

A selling strategy consists of when and how to sell.

When to sell

This requires an understanding of the farm's internal business factors, including:

- production risk
- a target price based on cost of production and a desired profit margin
- business cash-flow requirements.

How to sell

This is more dependent on external market factors, including:

- time of year, which determines the pricing method
- market access, which determines where to sell
- relative value, which determines what to sell.

Figure 2 lists key selling principles when considering sales during the growing season.

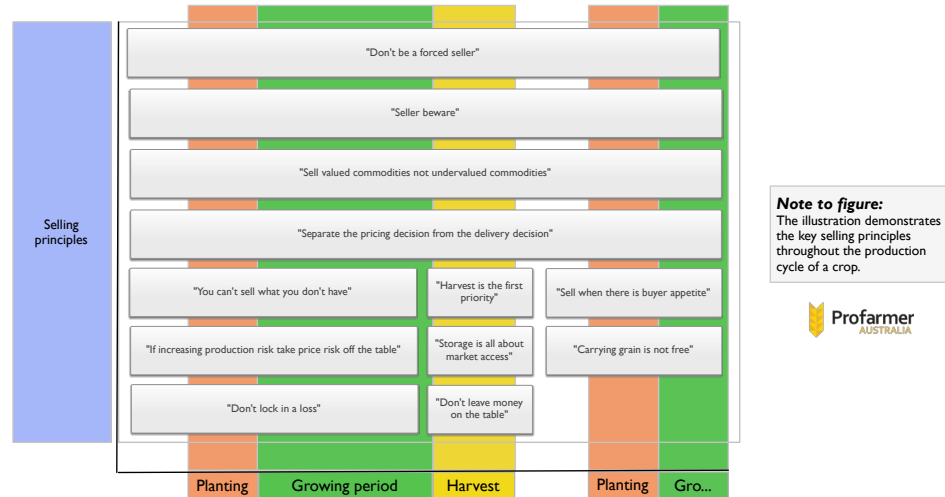

Figure 2: Grower commodity selling principles timeline.

15.1.2 Establishing the business risk profile – when to sell

Establishing your business risk profile allows the development of target price ranges for each commodity and provides confidence to sell when the opportunity arises. Typical business circumstances and how to quantify those risks during the production cycle are described in Figure 3.

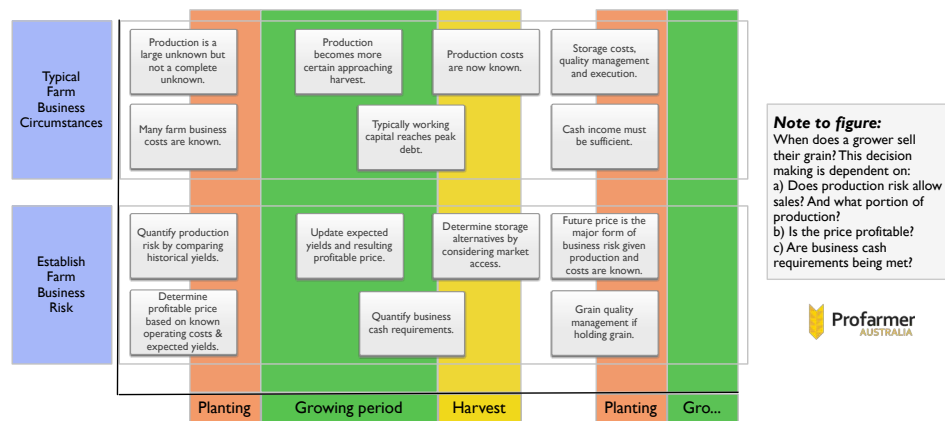

Figure 3: Typical farm business circumstances and risk.

Production risk profile of the farm

Production risk is the level of certainty around producing a crop and is influenced by location (climate and soil type), crop type, crop management and time of the year.

Principle: 'You can't sell what you don't have.' Don't increase business risk by overcommitting production.

Establish a production risk profile by:

- collating historical average yields for each crop type and a below-average and above-average range
- assessing the likelihood of achieving average based on recent seasonal conditions and seasonal outlook
- revising production outlooks as the season progresses.

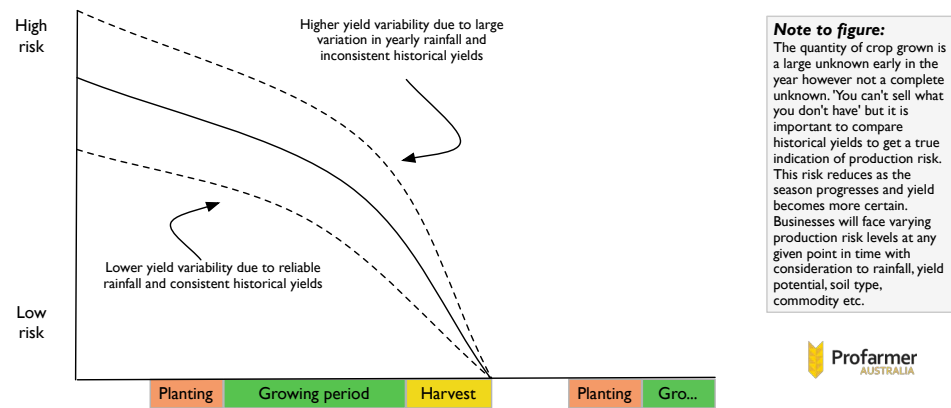

Figure 4: Typical production risk profile of a farm operation.

Farm costs in their entirety, variable and fixed costs (establishing a target price)

A profitable commodity target price is the cost of production per tonne plus a desired profit margin. It is essential to know the cost of production per tonne for the farm business.

Principle: 'Don't lock in a loss.' If committing production ahead of harvest, ensure the price is profitable.

Steps to calculate an estimated profitable price based on total cost of production and a range of yield scenarios is provided in Figure 5.

Estimating cost of production - Wheat	
Planted Area	1,200 ha
Estimate Yield	2.85 t/ha
Estimated Production	3,420 t
Fixed costs	
Insurance and General Expenses	\$100,000
Finance	\$80,000
Depreciation/Capital Replacement	\$70,000
Drawings	\$60,000
Other	\$30,000
Variable costs	
Seed and sowing	\$48,000
Fertiliser and application	\$156,000
Herbicide and application	\$78,000
Insect/fungicide and application	\$36,000
Harvest costs	\$48,000
Crop insurance	\$18,000
Total fixed and variable costs	\$742,000
Per Tonne Equivalent (Total costs + Estimated production)	\$212 /t
Per tonne costs	
Levies	\$3 /t
Cartage	\$12 /t
Freight to Port	\$22 /t
Total per tonne costs	\$37 /t
Cost of production Port track equiv	\$248.70
Target profit (ie 20%)	\$50.00
Target price (port equiv)	\$298.70

Step 1: Estimate your production potential. The more uncertain your production is, the more conservative the yield estimate should be. As yield falls, your cost of production per tonne will rise.

Step 2: Attribute your fixed farm business costs. In this instance if 1,200 ha reflects 1/3 of the farm enterprise, we have attributed 1/3 fixed costs. There are a number of methods for doing this (see M Klaus "Farming your Business") but the most important thing is that in the end all costs are accounted for.

Step 3: Calculate all the variable costs attributed to producing that crop. This can also be expressed as \$ per ha x planted area.

Step 4: Add together fixed and variable costs and divide by estimated production

Step 5: Add on the "per tonne" costs like levies and freight.

Step 6: Add the "per tonne" costs to the fixed and variable per tonne costs calculated at step 4.

Step 7: Add a desired profit margin to arrive at the port equivalent target profitable price.

Figure 5: Steps to calculate an estimated profitable price for soybeans.

The GRDC manual '[Farming the business—sowing for your future](#)' also provides a cost-of-production template and tips on grain selling versus grain marketing.

Income requirements

Understanding farm business cash-flow requirements and peak cash debt enables grain sales to be timed so that cash is available when required. This prevents having to sell grain below the target price to satisfy a need for cash.

Principle: 'Don't be a forced seller.' Be ahead of cash requirements to avoid selling in unfavourable markets.

A typical cash flow to grow a crop is illustrated in Figure 6. Costs are incurred upfront and during the growing season with peak working capital debt incurred at or before harvest. This will vary depending on circumstance and enterprise mix. Figure 7 demonstrates how managing sales can change the farm's cash balance.

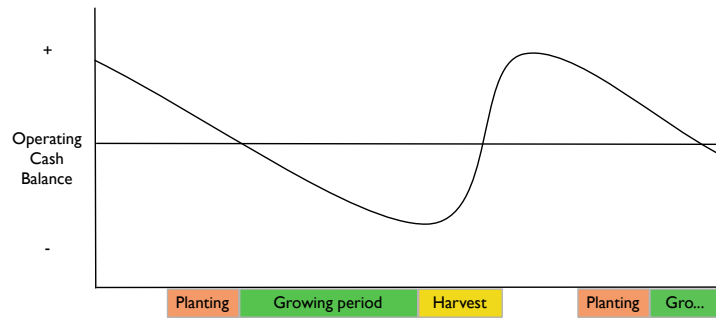

Note to figure:
The chart illustrates the operating cash flow of a typical farm assuming a heavy reliance on cash sales at harvest. Costs are incurred during the season to grow the crop, resulting in peak operating debt levels at or near harvest. Hence at harvest there is often a cash injection required for the business. An effective marketing plan will ensure a grower is 'not a forced seller' in order to generate cash flow.



In this scenario peak cash surplus starts higher and peak cash debt is lower

Figure 6: Typical farm operating cash balance, assuming harvest cash sales.

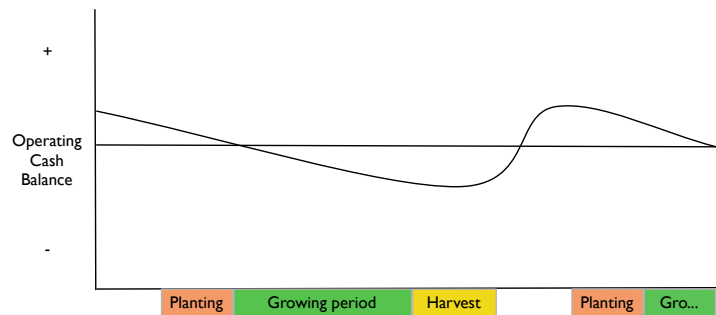

Note to figure:
By spreading sales throughout the year a grower may not be as reliant on executing sales at harvest time in order to generate required cash flow for the business. This provides a greater ability to capture pricing opportunities in contrast to executing sales in order to fulfil cash requirements.



In this scenario peak cash surplus starts lower and peak cash debt is higher

Figure 7: Typical farm operating cash balance, assuming cash sales spread throughout the year.

Summary

The 'when to sell' steps above result in an estimated production tonnage and the risk associated with that tonnage, a target price range for each commodity and the time of year when cash is most needed.

15.1.3 Managing your price—how to sell

This is the second part of the selling strategy.

Methods of price management

Pricing products provide varying levels of price risk coverage (Table 1).

Table 1: Pricing methods and their use for various crops

Description	Wheat	Barley	Canola	Sorghum	Maize	Faba bean	Chick peas
Fixed price products	Cash, futures, bank swaps	Cash, futures, bank swaps	Cash, futures, bank swaps	Cash, futures, bank swaps	Cash, futures, bank swaps	Cash	Cash
Floor price products	Options on futures, floor price pools	Options on futures	Options on futures	Options on futures	Options on futures	none	none
Floating price products	Pools	Pools	Pools	Pools	Pools	Pools	Pools

Figure 8 provides a summary of where different methods of price management are suited for the majority of farm businesses.

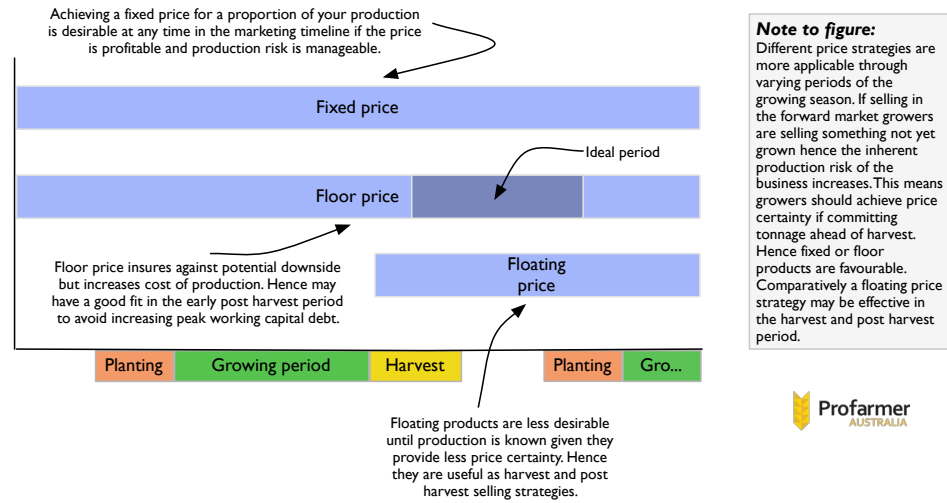

Figure 8: Price strategy timeline through the growing season.

Principle: 'If increasing production risk, take price risk off the table.' When committing unknown production, price certainty should be achieved to avoid increasing overall business risk.

Principle: 'Separate the pricing decision from the delivery decision.' Most commodities can be sold at any time, with delivery timeframes negotiable; hence price management is not determined by delivery.

Fixed price

A fixed price is achieved via cash sales and/or selling a futures position (swaps), shown in Figure 9. It provides some certainty around expected revenue from a sale as the price is largely a known, except when there is a floating component in the price, for example, a multi-grade cash contract with floating spreads or a floating basis component on futures positions.

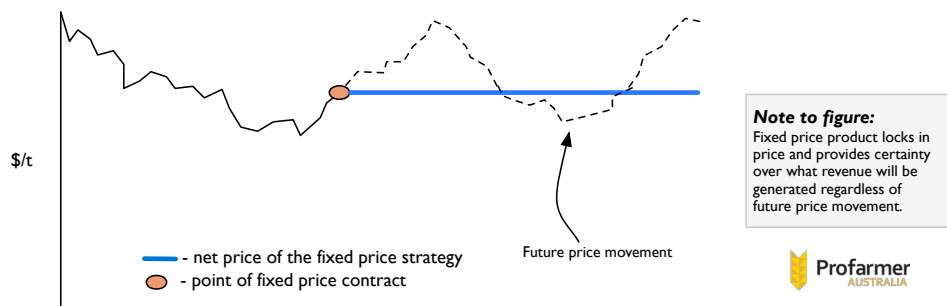
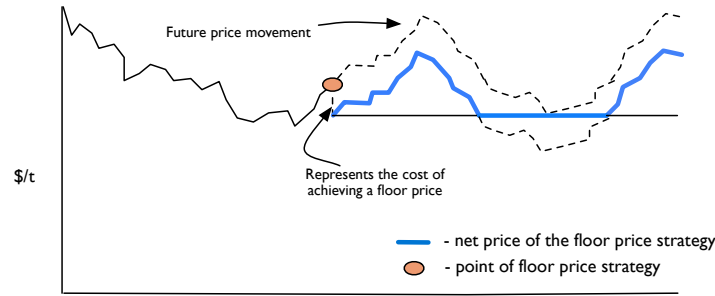

Figure 9: Fixed-price strategy.

Floor price

Floor price strategies can be achieved by utilising 'options' on a relevant futures exchange (if one exists) or via a managed sales program product by a third party (i.e., a pool with a defined floor price strategy). This pricing method protects against potential future downside while capturing any upside (Figure 10). The disadvantage is that the price 'insurance' has a cost, which adds to the farm businesses cost of production.



Note to figure:
A floor price strategy insures against potential future downside in price while allowing price gains in the event of future price rallies.



Figure 10: Floor-price strategy.

Floating price

Many of the pools or managed sales programs are a floating price where the net price received will move both up and down with the future movement in price (Figure 11). Floating-price products provide the least price certainty and are best suited for use at or after harvest rather than pre-harvest.

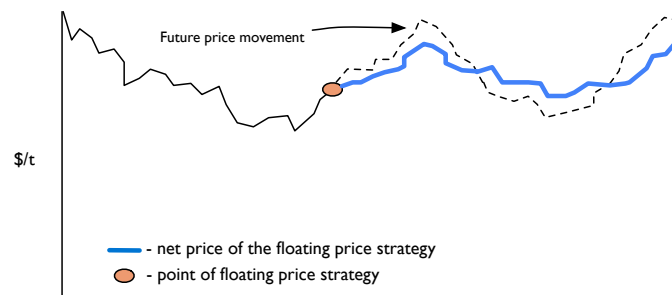

Note to figure:
A floating price will move to some extent with future price movements.



Figure 11: Floating-price strategy.

Summary

Fixed-price strategies include physical cash sales or futures products and provide the most price certainty but production risk must be considered.
 Floor-price strategies include options or floor-price pools. They provide a minimum price with upside potential and rely less on production certainty but cost more.
 Floating-price strategies provide minimal price certainty and are best used after harvest.

15.1.4 Ensuring access to markets

Once the selling strategy of when and how to sell is sorted, planning moves to storage and delivery of commodities to ensure timely access to markets and execution of sales. At some point, growers need to deliver the commodity to market. Hence planning on where to store the commodity is important in ensuring access to the market that is likely to yield the highest return.

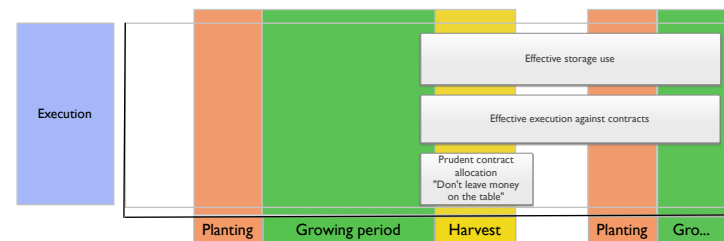

Note to figure:
Once a grower has made the decision to sell the question becomes how they achieve this? The decision on how to sell is dependent on:
 a) Time of the year determines the pricing method
 b) Market Access determines where to sell.
 c) Relative value determines what to sell.



Figure 12: Effective storage decisions.

Storage and logistics

Return on investment from grain handling and storage expenses is optimised when storage is considered in light of market access to maximise returns, as well as harvest logistics.

Storage alternatives include variations around the bulk handling system, private off-farm storage and on-farm storage. Delivery and quality management are key considerations in deciding where to store your commodity (Figure 13).

Principle: ‘Harvest is the first priority.’ Getting the crop in the bin is most critical to business success during harvest; hence, selling should be planned to allow focus on harvest.

Bulk export commodities requiring significant quality management are best suited to the bulk-handling system. Commodities destined for the domestic end-user market, (e.g. feed lot, processor or container packer) may be more suited to on-farm or private storage to increase delivery flexibility.

Storing commodities on-farm requires prudent quality management to ensure delivery at agreed specifications and can expose the business to high risk if this aspect is not well planned. Penalties for out-of-specification grain on arrival at a buyer’s weighbridge can be expensive. The buyer has no obligation to accept delivery of an out-of-specification load. This means the grower may have to incur the cost of taking the load elsewhere while also potentially finding a new buyer. Hence there is potential for a distressed sale, which can be costly.

On-farm storage also requires prudent delivery management to ensure commodities are received by the buyer on time, with appropriate weighbridge and sampling tickets.

Principle: ‘Storage is all about market access.’ Storage decisions depend on quality management and expected markets.

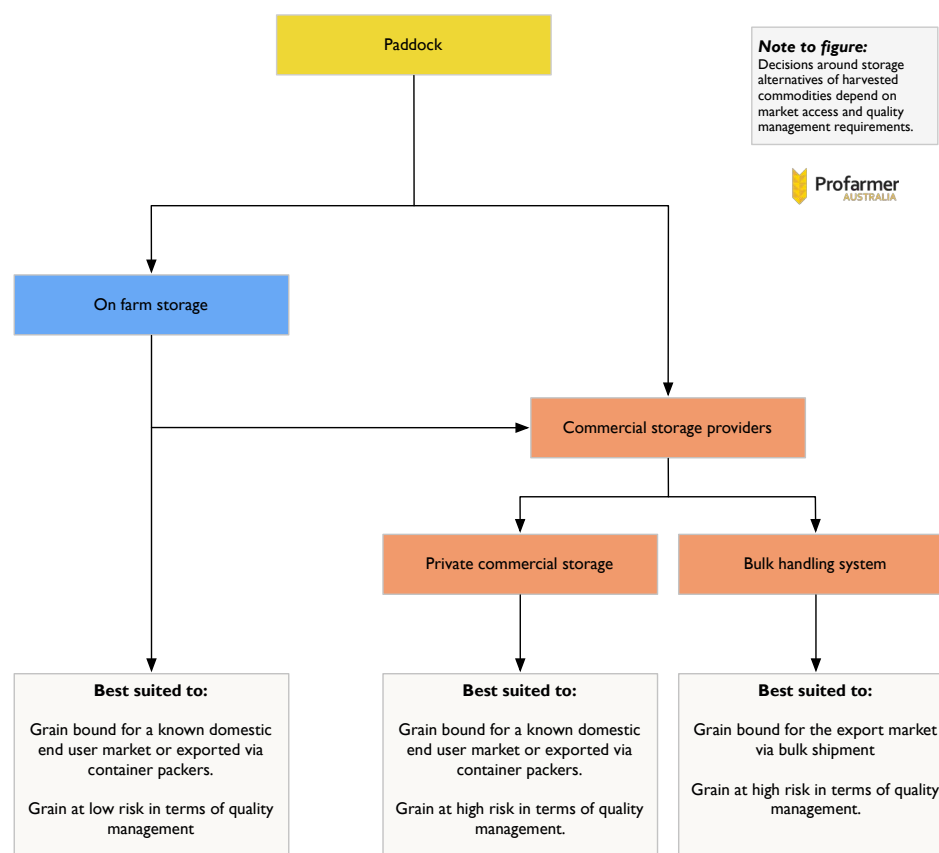

Figure 13: Grain-storage decision making.

Cost of carrying grain

Storing grain to access sales opportunities post-harvest invokes a cost to 'carry' grain. Price targets for carried grain need to account for the cost of carry.

Carry costs per month are typically \$3–4/t, consisting of:

- monthly storage fee charged by a commercial provider (typically ~\$1.50–\$2.00/t)
- monthly interest associated with having wealth tied up in grain rather than cash or against debt (~\$1.50–\$2.00/t), depending on the price of the commodity and interest rates.

The price of carried grain therefore needs to be \$3-4/t per month higher than what was offered at harvest.

The cost of carry applies to storing grain on-farm because there is a cost of capital invested in the farm storage plus the interest component. A reasonable assumption is \$3–\$4/t per month for on-farm storage.

Principle: 'Carrying grain is not free.' The cost of carrying grain needs to be accounted for if holding grain and selling it after harvest is part of the selling strategy (Figures 14 and 15).

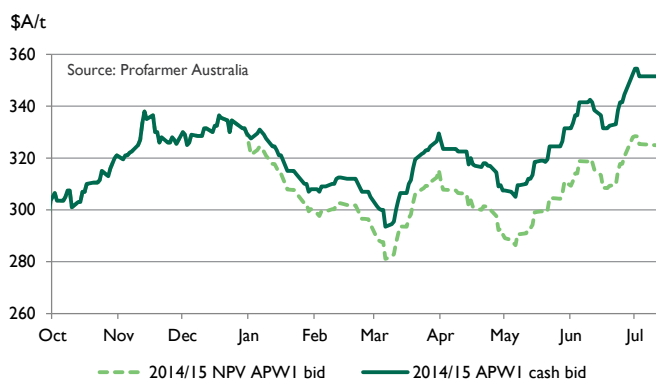

Note to figure: If selling a cash contract with deferred delivery, a carry charge can be negotiated into the contract. For example in the case of a March sale of APW1 wheat for March-June delivery on buyers call at \$300/t + \$3/t carry per month, if delivered in June would generate \$309/t delivered.

Figure 14: Brisbane APW1 cash vs NPV

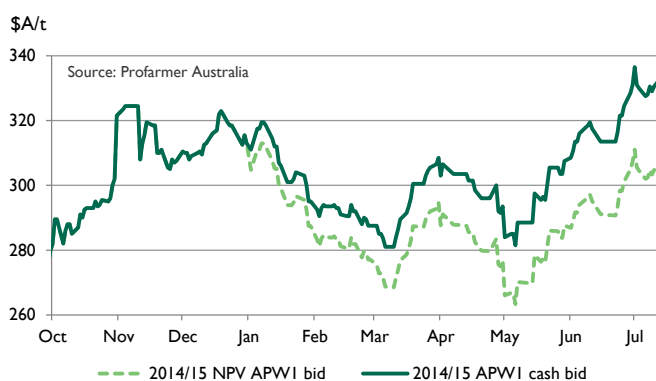

Note to figure: If selling a cash contract with deferred delivery, a carry charge can be negotiated into the contract. For example in the case of a March sale of APW1 wheat for March-June delivery on buyers call at \$300/t + \$3/t carry per month, if delivered in June would generate \$309/t delivered.

Figure 15: Newcastle APW1 cash vs NPV

Summary

Optimising farm-gate returns involves planning the appropriate storage strategy for each commodity to improve market access and cover carry costs in pricing decisions.

15.1.5 Executing tonnes into cash

This section provides guidelines for converting the selling and storage strategy into cash by effective execution of sales.

Set up the toolbox

Selling opportunities can be captured when they arise by assembling the necessary tools in advance. The toolbox includes:

1. **Timely information.** This is critical for awareness of selling opportunities and includes market information provided by independent parties; effective price discovery, including indicative bids, firm bids and trade prices; and other market information pertinent to the particular commodity.
2. **Professional services.** Grain-selling professional service offerings and cost structures vary considerably. An effective grain-selling professional will put their clients' best interests first by not having conflicts of interest and investing time in the relationship. Return on investment for the farm business through improved farm-gate prices is obtained by accessing timely information, greater market knowledge and greater market access from the professional service.
3. **Futures account and bank swap facility.** These accounts provide access to global futures markets. Hedging futures markets is not for everyone; however, strategies that utilise exchanges such as CBOT can add significant value.

For current financial members of Grain Trade Australia, including buyers, independent information providers, brokers, agents, and banks providing over-the-counter grain derivative products (swaps), go to <http://www.graintrade.org.au/membership>.

For a list of commodity futures brokers, go to <http://www.asx.com.au/prices/find-a-futures-broker.htm>.

How to sell for cash

Like any market transaction, a cash grain transaction occurs when a bid by the buyer is matched by an offer from the seller. Cash contracts are made up of the following components, with each component requiring a level of risk management:

- **Price.** Future price is largely unpredictable; hence, devising a selling plan to put current prices into the context of the farm business is critical to manage price risk.
- **Quantity and quality.** When entering a cash contract you are committing to delivery of the nominated amount of grain at the quality specified. Hence, production and quality risk must be managed.
- **Delivery terms.** Timing of title transfer from the grower to the buyer is agreed at time of contracting. If this requires delivery direct to end users, it relies on prudent execution management to ensure delivery within the contracted period.
- **Payment terms.** In Australia, the traditional method of contracting requires title of grain to be transferred ahead of payment; hence, counterparty risk must be managed.

Timing of delivery (title transfer) is agreed upon at time of contracting. Hence growers negotiate execution and storage risk they may have to manage.

Quantity (tonnage) and Quality (bin grade) determine the actuals of your commitment. Production and execution risk must be managed.

Price is negotiable at time of contracting.

Price point is important as it determines where in the supply chain the transaction will occur and so what costs will come out of the price before the grower's net return.

Whilst the majority of transactions are on the premise that title of grain is transferred ahead of payment this is negotiable. Managing counterparty risk is critical.

GTA Contract No.3 CONTRACT CONFIRMATION

GTA Trade Rules and Dispute Resolution Rules apply to this contract

This Contract is confirmation between:

BUYER Contract No: _____ Name: _____ Company: _____ Address: _____ Buyer ABN: _____ NGR No: _____	SELLER Contract No: _____ Name: _____ Company: _____ Address: _____ Seller ABN: _____ NGR No: _____
--	--

The Buyer and Seller agree to transact this Contract subject to the following Terms and Conditions:

Commodity: _____ Grade: _____ Quantity: _____ Packaging: _____ Price: _____ Price Basis: _____ Delivery/shipment Period: _____ Delivery Point and Conveyance: _____ Payment Terms: The buyer agrees to pay the seller within _____ In the absence of a declaration, payment will be 30 days end of week of delivery.	GTA Commodity Reference: _____ Inspection: _____ (Origin - Destination) Tolerance: _____ (Refer over) Weights: _____ (Origin - Destination) Excl/Incl/Free GST: _____ Levies and other charges: Any industry, statutory or government levies which are not included in the price of the commodity as required by law. Disclosures: Is any of the crop referred to in this contract subject to a mortgage, Encumbrance or lien and/or Plant Breeder's Rights and/or EPR liabilities and/or registered or unregistered Security Interest? <input checked="" type="radio"/> NO <input type="radio"/> YES (Please <input type="checkbox"/> appropriate box) If "yes" please provide details: _____ Other Special Terms and Conditions: _____
--	---

All Contract Terms and Conditions as set out above and on the reverse of this page form part of this Contract. Terms and Conditions written on the face of this Contract Confirmation shall overrule all printed Terms and Conditions on the reverse which conflict to the extent of the inconsistency. This Contract comprises the entire agreement between Buyer and Seller with respect to the subject matter of this Contract.

Recipient Created Tax Invoice (RCTI).
To assist with the processing of the Goods and Services Tax compliance, the buyer may prepare, for the seller, a Recipient Created Tax Invoice (RCTI). If the seller requires this service they are required to sign this declaration.
 Please issue a RCTI (Please ...)

Incorporation of GTA Trade & Dispute Resolution Rules:
This contract expressly incorporates the GTA Trade Rules in force at the time of this contract and Dispute Resolution Rules in force at the commencement of the arbitration, under which any dispute, controversy or claim arising out of, relating to or in connection with this contract, including any question regarding its existence, validity or termination, shall be resolved by arbitration.

Buyer's Name: _____ Buyer's Signature: _____ Date: _____	Seller's Name: _____ Seller's Signature: _____ Date: _____
--	--

This Contract has been executed and this form serves as confirmation and should be signed and a copy returned to the buyer/seller immediately. 2014 Edition
©GTA. For GTA member use only.

Grain Trade Australia is the industry body ensuring the efficient facilitation of commercial activities across the grain supply chain. This includes contract trade and dispute resolution rules. All wheat contracts in Australia should refer to GTA trade and dispute resolution rules.

Figure 16: Typical cash contracting, as per Grain Trade Australia standards.

The price point within a cash contract will depend on where the transfer of grain title will occur along the supply chain. Figure 17 depicts the terminology used to describe pricing points along the grain supply chain and the associated costs to come out of each price before growers receive their net farm-gate return.

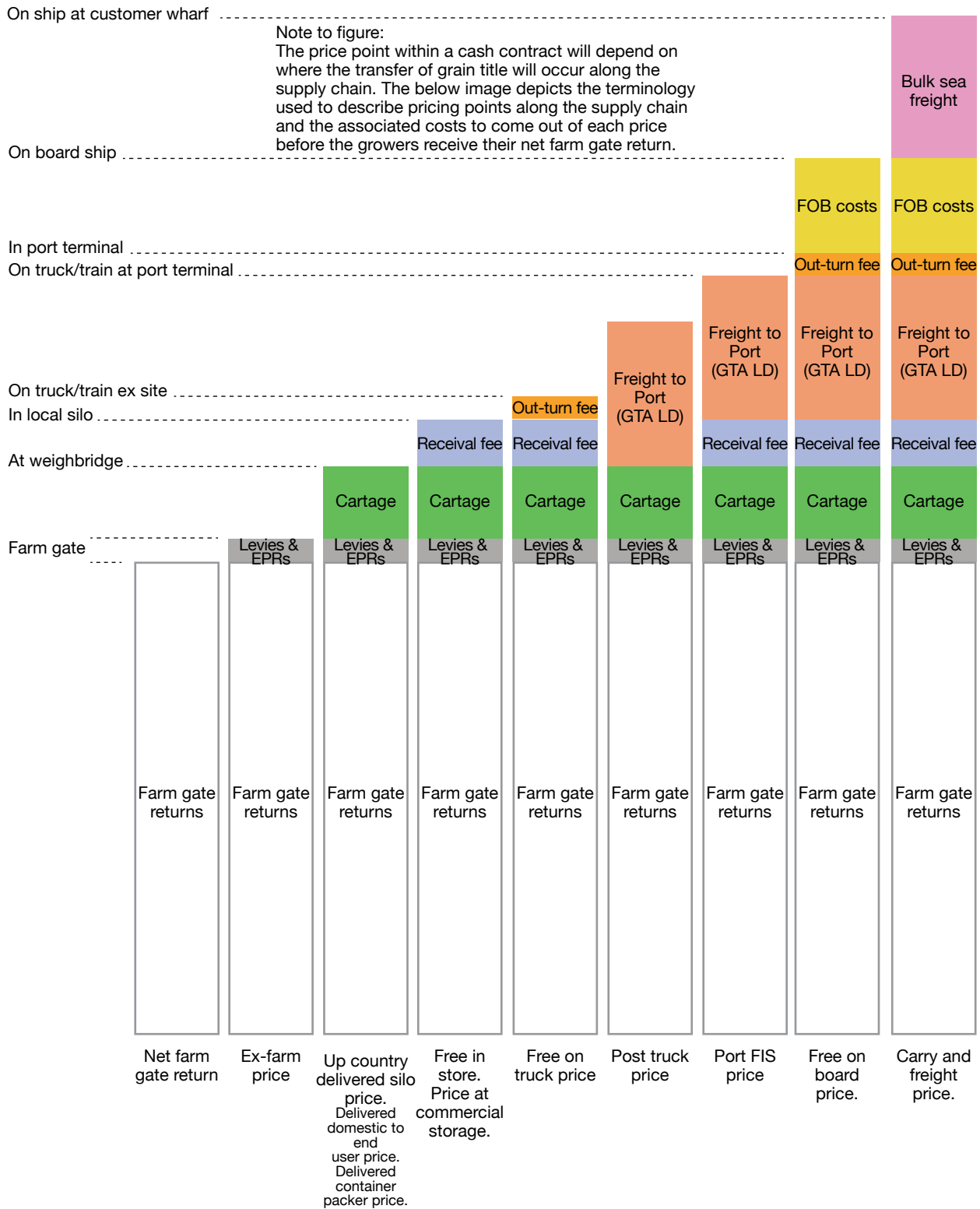

Figure 17: Costs and pricing points throughout the supply chain.

More information

[GTA: Guide to taking out contracts](#)

[GTA: Trade rules, contracts and vendor declarations](#)

[GTA: Trading standards](#)

[GrainCorp: GrainTransact Resource Centre](#)

[GrainFlow Network](#)

[Emerald Grain: Customer and grower logins](#)

[Clear Grain Exchange: Terms and conditions](#)

[Clear Grain Exchange: Getting started](#)

Cash sales generally occur through three methods:

1. **Negotiation via personal contact.** Traditionally, prices are posted as a 'public indicative bid'. The bid is then accepted or negotiated by a grower with the merchant or via an intermediary. This method is the most common and available for all commodities.
2. **Accepting a 'public firm bid'.** Cash prices in the form of public firm bids are posted during harvest and for warehoused grain by merchants on a site basis. Growers can sell their parcel of grain immediately by accepting the price on offer via an online facility and then transfer the grain online to the buyer. The availability of this depends on location and commodity.
3. **Placing an 'anonymous firm offer'.** Growers can place a firm offer price on a parcel of grain anonymously and expose it to the entire market of buyers, who then bid on it anonymously using the Clear Grain Exchange, which is an independent online exchange. If the firm offer and firm bid matches, the parcel transacts via a secure settlement facility, where title of grain does not transfer from the grower until funds are received from the buyer. The availability of this depends on location and commodity. Anonymous firm offers can also be placed to buyers by an intermediary acting on behalf of the grower. If the grain sells, the buyer and seller are disclosed to each counterparty.

Counterparty risk

Most sales involve transferring title of grain prior to being paid. The risk of a counterparty defaulting when selling grain is very real and must be managed. Conducting business in a commercial and professional manner minimises this risk.

Principle: 'Seller beware.' There is not much point selling for an extra \$5/t if you don't get paid.

Counterparty risk management includes the following:

- Deal only with known and trusted counterparties.
- Conduct a credit check (banks will do this) before dealing with a buyer you are unsure of.
- Only sell a small amount of grain to unknown counterparties.
- Consider credit insurance or a letter of credit from the buyer.
- Never deliver a second load of grain if payment has not been received for the first.
- Do not part with title of grain before payment or request a cash deposit of part of the value ahead of delivery. Payment terms are negotiable at time of contracting; alternatively the Clear Grain Exchange provides secure settlement whereby the grower maintains title of grain until payment is received by the buyer, and then title and payment is settled simultaneously.

Above all, act commercially to ensure the time invested in a selling strategy is not wasted by poor counterparty risk management. Achieving \$5/t more and not getting paid is a disastrous outcome.

Relative values

Grain sales revenue is optimised when selling decisions are made in the context of the whole farming business. The aim is to sell each commodity when it is priced well and hold commodities that are not well priced at any given time. That is, give preference to the commodities of the highest relative value. This achieves price protection for the overall farm business revenue and enables more flexibility to a grower's selling program while achieving the business goal of reducing overall risk.

Principle: 'Sell valued commodities, not undervalued commodities.' If one commodity is priced strongly relative to another, focus sales there. Don't sell the cheaper commodity for a discount.

An example based on wheat and barley production systems is provided in Figure 18.

More information

[GTA: Grain contracts – managing counterparty risk](#)

[Clear Grain Exchange title transfer model](#)

[GrainGrowers: Counterparty risk guide](#)

[Counterparty risk management: A producer perspective, Leo Delahunty](#)

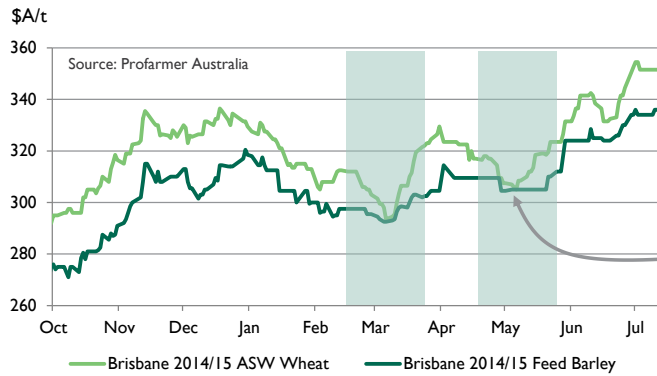

Note to figure:
Price relativities between commodities is one method of assessing which grain types 'hold the greatest value' in the current market.

Example:
Feed barley prices were performing strongly relative to ASW wheat values (normally ~15% discount) hence selling feed barley was more favourable than ASW wheat during this period.

Figure 18: Brisbane Australian Standard White (ASW) wheat versus feed barley (\$/t).

Contract allocation

Contract allocation means choosing which contracts to allocate your grain against come delivery time. Different contracts will have different characteristics (price, premiums–discounts, oil bonuses, etc.) and optimising your allocation reflects immediately on your bottom line (Figure 19).

Principle: 'Don't leave money on the table,' Contract allocation decisions don't take long and can be worth thousands of dollars to your bottom line.

To achieve the best average wheat price, growers should allocate:

- lower grades of wheat to contracts with the lowest discounts
- higher grades of wheat to contracts with the highest premiums.

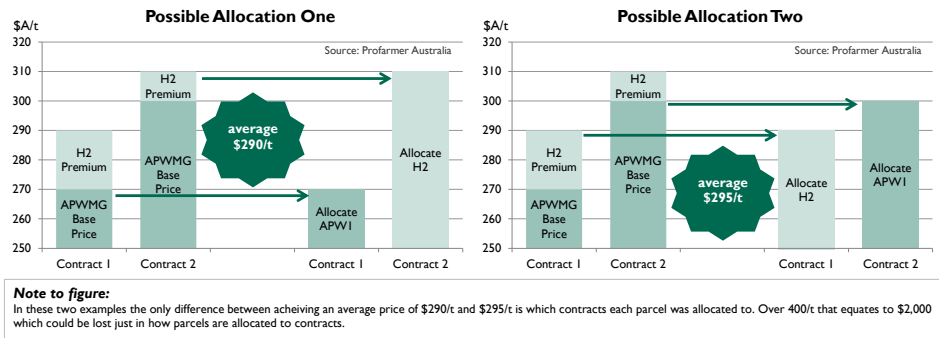

Note to figure:
In these two examples the only difference between achieving an average price of \$290/t and \$295/t is which contracts each parcel was allocated to. Over 400/t that equates to \$2,000 which could be lost just in how parcels are allocated to contracts.

Figure 19: Examples of contract allocation of grains.

Read market signals

The appetite of buyers to buy a particular commodity will differ over time depending on market circumstances. Ideally, growers should aim to sell their commodity when buyer appetite is strong and stand aside from the market when buyers are not that interested in buying the commodity.

Principle: 'Sell when there is buyer appetite.' When buyers are chasing grain, growers have more market power to demand a price when selling.

Buyer appetite can be monitored by:

- The number of buyers at or near the best bid in a public bid line-up. If there are many buyers, it could indicate buyer appetite is strong. However, if there is one buyer \$5/t above the next best bid, it may mean cash prices are susceptible to falling \$5/t if that buyer satisfies their buying appetite.
- Monitoring actual trades against public indicative bids. When trades are occurring above indicative public bids it may indicate strong appetite from merchants and the

ability for growers to offer their grain at price premiums to public bids. The chart below plots actual trade prices on the Clear Grain Exchange against the best public indicative bid on the day.

Summary

Figure 20 gives a summary of best practice for the selling process. The selling strategy is converted to maximum business revenue by:

- ensuring timely access to information, advice and trading facilities
- using different cash market mechanisms when appropriate
- minimising counterparty risk by effective due diligence
- understanding relative value and selling commodities when they are priced well
- thoughtful contract allocation
- reading market signals to extract value from the market or prevent selling at a discount

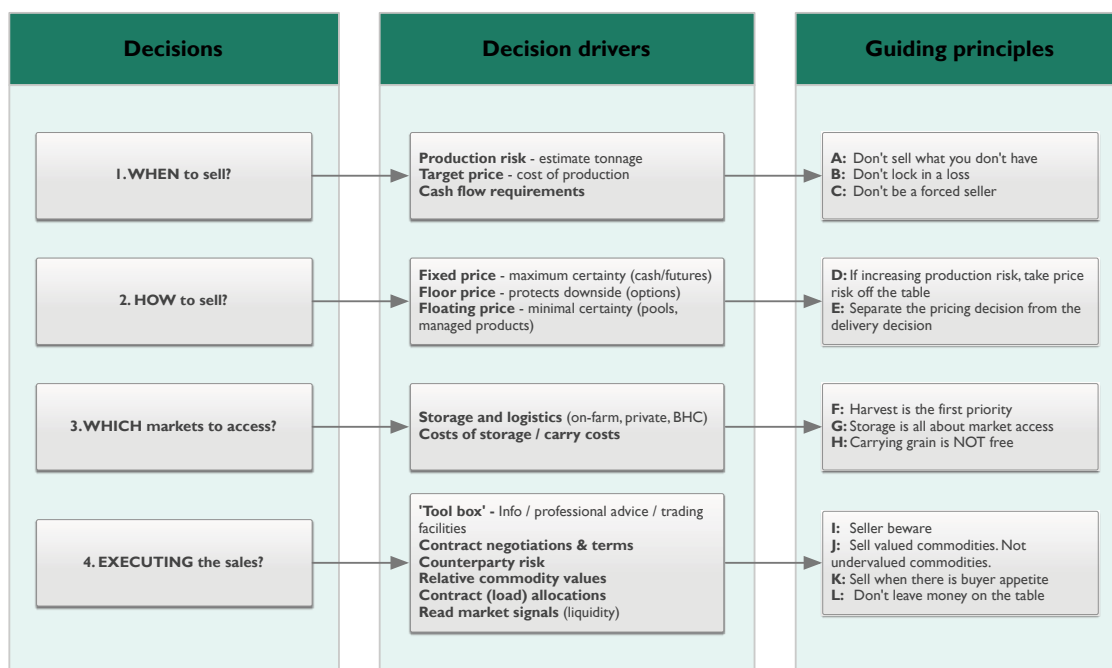

Figure 20: A summary of the marketing decisions required, the elements that drive them and the principles that guide them.

15.2 Northern soybeans – market dynamics and execution

15.2.1 Price determinants for northern soybeans

There are two main end uses of Australian soybean seed: the crush market for both oil and meal, and the edible market. The Australian soybean market remains relatively small but is part of a global complex that is one of the largest produced commodities in the world. The global soybean crop ranges from 200 to 320 Mt annually, with Australia only producing 50–100 Kt each year, a miniscule proportion of the overall global crop. The top seven global producers make up 94% of the total production and include US (107 Mt), Brazil (100 Mt), Argentina, China, Paraguay, India and Canada.

A large proportion of the Australian crop is consumed domestically; it is estimated that roughly half the crop is bound for the domestic crush market. The crush market generally sets the market price; however, the edible market has continued to grow and now consumes a considerable proportion of the domestic crop. Culinary-grade

soybeans are both exported for the edible trade and consumed locally. The darker variety hila is typically used by oilseed crushers, of which soymeal is a by-product and used for stockfeed. Comparatively, the lighter variety hila is typically used in the edible trade.

Local values are heavily impacted by global values due to the extensive volumes of soybean meal imported into Australia each season. ABARES forecast 730,000 t of soybean meal was imported into Australia throughout the 2014–15 season, which is considerably more than what was produced locally.

Hence, a significant influence of local soybean prices is the price of imported soybean meal. The largest user of soybean meal is the poultry industry, which acts as an important driver for determining imported volumes each season. Soybeans are predominately crushed for meal; however, they are also used for oil. Despite the oil share being lower than other oilseeds, values are still influenced by the cost of competitor oils.

The edible trade is usually priced at a notable premium based on a buyer’s preference for a particular grade variety. Importantly, the crush sector also acts as a ‘backstop’ for edible-grade soybeans that don’t make the culinary standards.

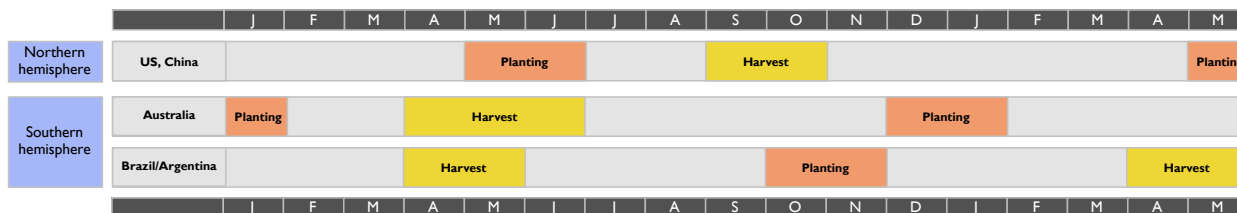

Figure 21: Comparison of global safflower and soybean crop calendars.

15.2.2 Executing tonnes into cash for Northern soybeans

Knowing where the northern Australian soybean crop is likely to end up will help refine a grower’s selling and logistics decisions. Broadly there are two customer types:

- Customer type A. those buyers sourcing soybean varieties to process for the edible trade.
- Customer type B. Those buyers sourcing soybean varieties for the domestic crush.

i More information

[Farming system update: Soybeans growing guide for Queensland](#)

[Australian Oilseed Federation](#)

[Soy Australia](#)

[Soy Australia: Sybean marketing guide for growers](#)

Type A are typically oilseed processors who purchase soybeans for the crush market directly into their plant. Additionally, there are active merchants who have identified an opportunity and will purchase soybeans and on-sell the product to the end user. Soybeans bound for the crush market can be contracted prior to production or alternatively sold into the cash market post-harvest.

Comparatively, type B customers buy for either export or domestic use in the culinary market. Markets are fairly liquid; however, variety-specific segments exist. Given the need to meet strict culinary standards, crush and edible varieties must be segregated carefully. Buyers have a variety of grain standards and, given the premiums available for culinary standard soybeans, maintaining quality is of the utmost importance.

Closed-loop marketing is available for some specialty edible soybean varieties; however, this market segment remains comparatively small.

SECTION 16

Current research

Project Summaries of GRDC-supported projects in 2013-14

Each year the GRDC supports several hundred research and development, and capacity building projects.

In the interests of improving awareness of these investments among growers, advisers and other stakeholders, the GRDC has assembled summaries of projects active in 2013-14.

These summaries are written by our research partners as part of the Project Specification for each project, and are intended to communicate a useful summary of the research activities for each project investment.

The review expands our existing communication products where we summarise the R&D portfolio in publications such as the Five-year Strategic Research and Development Plan, the Annual Operating Plan, the Annual Report and the Growers Report.

GRDC's project portfolio is dynamic with projects concluding and new projects commencing on a regular basis. Project Summaries are proposed to become a regular publication, available to everyone from the GRDC website.

Projects are assembled by GRDC R&D investment Theme area, as shown in the PDF documents available. For each Theme a Table of Contents of what is contained in the full PDF is also provided, so users can see a list of project titles that are covered. The GRDC investment Theme areas are:

- [Meeting market requirements;](#)
- [Improving crop yield;](#)
- [Protecting your crop;](#)
- [Advancing profitable farming systems;](#)
- [Maintaining the resource base; and](#)
- [Building skills and capacity.](#)

The GRDC values the input and feedback it receives from its stakeholders and so would welcome your feedback on any aspect of this first review. This way we can continue to improve and extend this summary.

To send us your feedback please email us at feedback@grdc.com.au

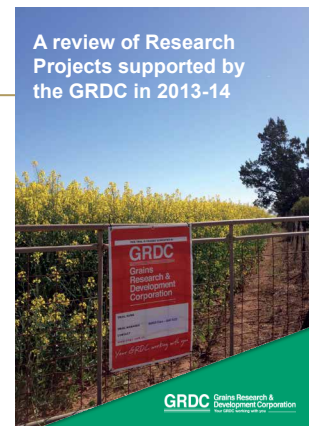

SECTION 17

Key contacts

GRDC Northern Regional Panelists

James Clark - Chair

James Clark lives in the NSW Hunter Valley and brings to the panel his extensive experience in both dryland and irrigated farming in the North Star area of northern NSW. James has served as a panellist since 2005 and chair since 2008. He says the role of the panel is to capture growers' priorities, realise them into a pipeline of investments and empower growers to take up production gain opportunities as they arise. He believes the grains industry needs to continue to build future RD&E capacity and capability to service its needs going forward and ensure growers remain as competitive as possible.

M 0427 545 212 E colane@bigpond.com



Loretta Serafin

Loretta Serafin has extensive experience as an agronomist in northwest NSW and works with the NSW Department of Primary Industries in Tamworth. As the leader northern dryland cropping systems, she provides expertise and support to growers, industry and agronomists in the production of summer crops. Loretta is a member of numerous industry bodies and has a passion for helping growers improve farm efficiency. She sees her role as a conduit between advisers, growers and the GRDC to ensure growers' research needs are being met.

M 0427 311 819 E loretta.serafin@dpi.nsw.gov.au



Jules Dixon

Jules Dixon has an extensive background in agronomy and an established network spanning eastern Australia and WA including researchers, leading growers and agronomy consultants through to the multinational privatesector. Based in Sydney, Jules operates a private consultancy specialising in agronomy, strategy development and business review.

M 0429 494 067 E juliannedixon@bigpond.com



Neil Fettell

Neil Fettell is a part-time senior research adviser with Central West Farming Systems and runs a small irrigation farm near Condobolin, NSW. Neil has a research agronomy background, conducting field research in variety improvement, crop physiology and nutrition, water use efficiency and farming systems. He is a passionate supporter of research that delivers productivity gains to growers, and of grower participation in setting research goals.

M 0427 201 939 E fettells@esat.net.au



Penny Heuston

Penny Heuston is an agronomist based in Warren, NSW. She is passionate about the survival of the family farm and its role in the health of local economies. Penny is dedicated to ensuring research is practical, farm-ready and based on sound science and rigor. She sees 'two-way communication' as one of the panellists' primary roles and is committed to bringing issues from the paddock to 'the lab' and conversely, the science to the paddock.

M 0428 474 845 E pennyheuston@bigpond.com



Andrew McFadyen

Andrew McFadyen is an agronomist and manager with Paspaley Pastoral Company near Coolah, NSW, with more than 15 years' agronomy and practical farm management experience. He is an active member of the grains industry with former roles on the Central East Research Advisory Committee, NSW Farmers Coolah branch and planning committees for GRDC Updates. He is also a board member and the chair of Grain Orana Alliance.

M 0427 002 162 E amcfadyen@paspaley.com.au



John Minogue

John Minogue runs a mixed broadacre farming business and an agricultural consultancy, Agriculture and General Consulting, at Barmedman in south-west NSW. John is chair of the district council of the NSW Farmers' Association, sits on the grains committee of the NSW Farmers' Association and is a winner of the Central West Conservation Farmer of the Year award. His vast agricultural experience in centralwest NSW has given him a valuable insight into the long-term grains industry challenges.

M 0428 763 023 E jminogue@bigpond.com



Jack Williamson

Jack Williamson is a private agricultural consultant and helps run a family broadacre farm near Goondiwindi, Queensland. Six years of retail agronomy and three years of chemical sales management have given Jack extensive farming systems knowledge, and diverse crop management and field work experience. He is a member of the Northern Grower Alliance local consultative committee and Crop Consultants Australia.

M 0438 907 820 E jack.williamson1@bigpond.com



Arthur Gearon

Arthur Gearon is a grain, cotton and beef producer located near Chinchilla, Queensland. He has a business degree from the Queensland University of Technology in international business and management and has completed the Australian Institute of Company Directors course. He is vice-president of AgForce Grains and has an extensive industry network throughout Queensland. Arthur believes technology and the ability to apply it across industry will be the key driver for economic growth in the grains industry.

M 0427 016 658 E agearon@bigpond.com



Dr Tony Hamilton

Tony Hamilton is a grower from Forbes, NSW, and managing director of an integrated cropping and livestock business. He is a member of GRDC's Regional Cropping Solutions Network-Irrigation panel and a director of the Rural Industries Research and Development Corporation. He has worked as an agricultural consultant in WA and southern NSW. With a Bachelor of Agricultural Science and a PhD in agronomy, Tony advocates agricultural RD&E and evidence-based agriculture.

M 0406 143 394 E tony@merriment.com.au



Brondwen MacLean

Brondwen MacLean was appointed to the Northern Panel in August 2015 and is the GRDC executive manager for research programs. She has primary accountability for managing all aspects of the GRDC's nationally coordinated R&D investment portfolio and aims to ensure that these investments generate the best possible return for Australian grain growers. Prior to her current appointment, Brondwen was senior manager, breeding programs, and theme coordinator for Theme 6, Building Skills and Capacity.

T 02 6166 4500 E brondwen.maclea@grdc.com.au



David Lord - Panel Support Officer

David Lord operates Lord Ag Consulting, an agricultural consultancy service. Previously, David worked as a project officer for Independent Consultants Australia Network, which gave him a good understanding of the issues growers are facing in the northern grains region. David is the Northern Panel and Regional Grower Services support officer.

M 0422 082 105 E northernpanel@gmail.com



SECTION 18

References

Section A. Introduction

- Australian Oilseeds Federation (2013) Better Soybeans manual http://www.australianoilseeds.com/soy_australia/Soybean_Production
- GRDC (2014) Australian Soybeans come of age <http://www.grdc.com.au/Media-Centre/Ground-Cover/Ground-Cover-Issue-113-NovDec-2014/Australian-soybeans-come-of-age-sthash.2qlG1Lio.dpuf>
- Index Mundi, Australia Soybean Oilseed Production by Year: <http://www.indexmundi.com/agriculture/?country=au&commodity=soybean-oilseed&graph=production>
- Soy Australia: http://www.australianoilseeds.com/soy_australia
- Soy Australia, soybean fact sheets: http://www.australianoilseeds.com/soy_australia/soybean_fact_sheets

Section 1. Planning and paddock preparation

- Australian Oilseeds Federation (2013) Better Soybeans manual, http://www.australianoilseeds.com/soy_australia/Soybean_Production
- M Bennett (2008) Soybean Production Recommendations for the NT, <http://www.nt.gov.au/d/Content/File/p/Crop/659.pdf>
- DR Sparkes and C Charleston, Adoption of Soybeans as a Rotation Crop in Far North Queensland, http://www.australianoilseeds.com/_data/assets/file/0013/1192/Catherine_Charleston-Adoption_of_Soybeans_as_a_Rotation_Crop_in_Far_North_Queensland.pdf
- GR Stirling, NV Halpin, MJ Bell and PW Moody (2010) Impact of tillage and residues from rotation crops on the nematode community in soil and surface mulch during the following sugarcane crop, http://www.assct.com.au/media/pdfs/Ag_6_Stirling.pdf
- Weed control in soybean crops can be a valuable investment in your cane crop, http://www.sugarresearch.com.au/icms_docs/157925_Bulletin_Edition_36_2013_Weed_control_in_soybean_crops.pdf

Section 2. Pre-planting

- Agriculture Victoria, Growing Soybean, <http://agriculture.vic.gov.au/agriculture/grains-and-other-crops/crop-production/growing-soybean>
- Australian Oilseeds Federation (2013) Better Soybeans manual, http://www.australianoilseeds.com/soy_australia/Soybean_Production
- GRDC (2014) Australian soybeans come of age, <http://www.grdc.com.au/Media-Centre/Ground-Cover/Ground-Cover-Issue-113-NovDec-2014/Australian-soybeans-come-of-age-sthash.vnggwGHJ.dpuf>
- Incitec Pivot Limited, <http://www.incitecpivot.com.au/>
- NSW Soybean Grower Guidelines, http://www.australianoilseeds.com/_data/assets/pdf_file/0009/7668/Inland_NSW_Soybean_Grower_Guidelines.pdf

Qld DAF (2010) Growing soybeans, <https://www.daf.qld.gov.au/plants/field-crops-and-pastures/broadacre-field-crops/soybeans/growing-guide>

Section 3. Planting

Australian Oilseeds Federation (2013) Better Soybeans manual, http://www.australianoilseeds.com/soy_australia/Soybean_Production

Section 4. Plant growth and physiology

Australian Oilseeds Federation (2013) Better Soybeans manual, http://www.australianoilseeds.com/soy_australia/Soybean_Production

NSW DPI (2007) SOYBEAN : North Coast NSW Planting Guide, http://www.australianoilseeds.com/_data/assets/pdf_file/0020/7670/Soybean_North_Coast_NSW_Planting_Guide.pdf

Section 5. Nutrition and fertiliser

Agriculture Victoria, Growing Soybean, <http://agriculture.vic.gov.au/agriculture/grains-and-other-crops/crop-production/growing-soybean>

Australian Oilseeds Federation (2013) Better Soybeans manual, http://www.australianoilseeds.com/soy_australia/Soybean_Production

Qld DAF (2010) Growing soybeans, <https://www.daf.qld.gov.au/plants/field-crops-and-pastures/broadacre-field-crops/soybeans/growing-guide>

Section 6. Weed control

Australian Oilseeds Federation (2013) Better Soybeans manual, http://www.australianoilseeds.com/soy_australia/Soybean_Production

Section 7. Insect control

Australian Oilseeds Federation (2013) Better Soybeans manual, http://www.australianoilseeds.com/soy_australia/Soybean_Production

Section 8. Nematode management

Australian Oilseeds Federation (2013) Better Soybeans manual, http://www.australianoilseeds.com/soy_australia/Soybean_Production

Section 9. Diseases

Australian Oilseeds Federation (2008) Queensland Soybean Grower Guidelines, http://www.australianoilseeds.com/_data/assets/pdf_file/0010/7669/Queensland_Soybean_Grower_Guidelines.pdf

Australian Oilseeds Federation (2013) Better Soybeans manual, http://www.australianoilseeds.com/soy_australia/Soybean_Production

NSW DPI (2007) SOYBEAN: North Coast NSW Planting Guide, http://www.australianoilseeds.com/_data/assets/pdf_file/0020/7670/Soybean_North_Coast_NSW_Planting_Guide.pdf

Section 11. Crop desiccation/spray out

Australian Oilseeds Federation (2013) Better Soybeans manual, http://www.australianoilseeds.com/soy_australia/Soybean_Production

Qld DAF (2010) Harvest and drying, <https://www.daf.qld.gov.au/plants/field-crops-and-pastures/broadacre-field-crops/soybeans/harvesting-and-drying>

Section 12. Harvest

Australian Oilseeds Federation (2013) Better Soybeans manual, http://www.australianoilseeds.com/soy_australia/Soybean_Production

NSW DPI (2007) SOYBEAN : North Coast NSW Planting Guide, http://www.australianoilseeds.com/_data/assets/pdf_file/0020/7670/Soybean_North_Coast_NSW_Planting_Guide.pdf

Section 13. Storage

Australian Oilseeds Federation (2013) Better Soybeans manual, http://www.australianoilseeds.com/soy_australia/Soybean_Production

Section 14. Environmental issues

Australian Oilseeds Federation (2013) Better Soybeans manual, http://www.australianoilseeds.com/soy_australia/Soybean_Production

GRDC (2014) Frost damage in crops: where to from here? <http://grdc.com.au/Research-and-Development/GRDC-Update-Papers/2014/03/Frost-damage-in-crops-where-to-from-here-sthash.rtANxuaU.dpuf>